

# NTN®

## Precision Rolling Bearings

CAT.No.2260-VIII/E



*C O N T E N T S*

**NTN  
PRECISION  
ROLLING  
BEARINGS**

**Technical Data**

**Main Spindle  
Bearings**

**Ball Screw Support  
Bearings**

**NTN PRODUCTS**

**APPENDIX**

<b>1. Classification of Precision Rolling Bearings for Machine Tools</b> .....	2
<b>2. Bearing Selection and Shaft &amp; Housing Design</b> .....	5
<b>3. Load Rating and Life</b> .....	16
<b>4. Allowable Speed</b> .....	21
<b>5. Bearing Arrangements and Structures of Bearings for Main Spindles</b> .....	22
<b>6. Handling of Bearings</b> .....	27
<b>7. Lubrication of Bearings</b> .....	39
<b>8. New Technologies</b> .....	48
<b>9. Angular Contact Ball Bearings for Radial Loads</b> .....	55
<b>10. Cylindrical Roller Bearing</b> .....	209
<b>11. Angular Contact Ball Bearings for Axial Loads</b> .....	241
<b>12. Tapered Roller Bearings</b> .....	267
<b>13. Ball Screw Support Bearings</b> .....	275
<b>14. NTN Products Cam followers for pallet changer</b> .....	306
<b>15. Appendix</b> .....	310

## Warranty

NTN warrants, to the original purchaser only, that the delivered product which is the subject of this sale (a) will conform to drawings and specifications mutually established in writing as applicable to the contract, and (b) be free from defects in material or fabrication. The duration of this warranty is one year from date of delivery. If the buyer discovers within this period a failure of the product to conform to drawings or specifications, or a defect in material or fabrication, it must promptly notify NTN in writing. In no event shall such notification be received by NTN later than 13 months from the date of delivery. Within a reasonable time after such notification, NTN will, at its option, (a) correct any failure of the product to conform to drawings, specifications or any defect in material or workmanship, with either replacement or repair of the product, or (b) refund, in part or in whole, the purchase price. Such replacement and repair, excluding charges for labor, is at NTN's expense. All warranty service will be performed at service centers designated by NTN. These remedies are the purchaser's exclusive remedies for breach of warranty.

NTN does not warrant (a) any product, components or parts not manufactured by NTN, (b) defects caused by failure to provide a suitable installation environment for the product, (c) damage caused by use of the product for purposes other than those for which it was designed, (d) damage caused by disasters such as fire, flood, wind, and lightning, (e) damage caused by unauthorized attachments or modification, (f) damage during shipment, or (g) any other abuse or misuse by the purchaser.

**THE FOREGOING WARRANTIES ARE IN LIEU OF ALL OTHER WARRANTIES, EXPRESS OR IMPLIED, INCLUDING BUT NOT LIMITED TO THE IMPLIED WARRANTIES OF MERCHANTABILITY AND FITNESS FOR A PARTICULAR PURPOSE.**

In no case shall NTN be liable for any special, incidental, or consequential damages based upon breach of warranty, breach of contract, negligence, strict tort, or any other legal theory, and in no case shall total liability of NTN exceed the purchase price of the part upon which such liability is based. Such damages include, but are not limited to, loss of profits, loss of savings or revenue, loss of use of the product or any associated equipment, cost of capital, cost of any substitute equipment, facilities or services, downtime, the claims of third parties including customers, and injury to property. Some states do not allow limits on warranties, or on remedies for breach in certain transactions. In such states, the limits in this paragraph and in paragraph (2) shall apply to the extent allowable under case law and statutes in such states.

Any action for breach of warranty or any other legal theory must be commenced within 15 months following delivery of the goods.

Unless modified in a writing signed by both parties, this agreement is understood to be the complete and exclusive agreement between the parties, superceding all prior agreements, oral or written, and all other communications between the parties relating to the subject matter of this agreement. No employee of NTN or any other party is authorized to make any warranty in addition to those made in this agreement.

This agreement allocates the risks of product failure between NTN and the purchaser. This allocation is recognized by both parties and is reflected in the price of the goods. The purchaser acknowledges that it has read this agreement, understands it, and is bound by its terms.

# Precision Rolling Bearings










## TECHNICAL DATA CONTENTS





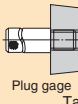
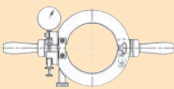
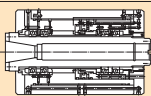






	Page
<b>1. Classification of Precision Rolling Bearings for Machine Tools</b> .....	2~4
① Main spindle bearings .....	2
② Ball screw support bearings .....	4
<b>2. Bearing Selection and Shaft &amp; Housing Design</b> .....	5~15
① Bearing selection .....	5
② Bearing accuracy .....	7
③ Bearings and rigidity .....	11
④ Designing bearing and housing .....	14
<b>3. Load Rating and Life</b> .....	16~21
① Bearing life .....	16
② Static load rating and allowable axial load .....	20
<b>4. Allowable Speed</b> .....	21
<b>5. Bearing Arrangements and Structures of Bearings for Main Spindles</b> .....	22~26
① Bearing arrangement for main spindles .....	22
② Bearing selection based on bearing arrangement for main spindle .....	24
③ Adjustable preload bearing unit .....	25
④ Bearing jacket cooling system .....	26
<b>6. Handling of Bearings</b> .....	27~38
① Cleaning and filling with grease .....	27
② Mounting .....	28
③ Tightening of inner ring .....	30
④ Elastic deformation of spacer resulting from tightening force .....	31
⑤ Front cover drive-up .....	31
⑥ Checking axial rigidity .....	32
⑦ Clearance adjustment for cylindrical roller bearing .....	33
⑧ Cylindrical roller bearing tapered bore and main spindle taper angle .....	37
⑨ Running-in operation for main spindle bearing .....	38
<b>7. Lubrication of Bearings</b> .....	39~47
① Grease lubrication .....	40
② Air-oil lubrication .....	41
③ Jet lubrication .....	47
<b>8. New Technologies</b> .....	48~53
① The new series of super-high-speed precision bearings for machine tool main spindles "ULTAGE Series" .....	48
② New material and new surface modification technology .....	48
③ Environmentally conscious technology .....	50

# 1. Classification of Precision Rolling Bearings for Machine Tools











## ① Main spindle bearings

Table .1 Types of precision rolling bearings for machine tools

Bearing type	Cross section	Bearing type	Bearing bore mm	Contact angle	Remarks	Page	
Angular contact ball bearing	Standard	78C	$\phi 25 \sim \phi 170$	15°	<ul style="list-style-type: none"> <li>A bearing type code containing a suffix U means an <b>ULTAGE</b> ULTAGE series bearing. Optimized interior structure and resin cage help positively inhibit temperature rise (applicable to 79 and 70 types with bore diameter of 10 to 130 mm).</li> <li>Bearings with prefix 5S have ceramic balls.</li> </ul>	84	
		79 (U), 5S-79 (U)	$\phi 10 \sim \phi 170$	15°, 25°, 30°		111	
		70 (U), 5S-70 (U)	$\phi 10 \sim \phi 200$	15°, 25°, 30°			
		72C	$\phi 10 \sim \phi 130$	15°			
	High-speed		2LA-HSE9U 5S-2LA-HSE9	$\phi 50 \sim \phi 170$	15°, 20°, 25°	<ul style="list-style-type: none"> <li><b>ULTAGE</b> ULTAGE series</li> <li>Use of special material and introduction of surface modification contribute to much improved wear resistance and anti-seizure property.</li> <li>Optimized specifications for the interior structure lead to higher speed, rigidity and reliability.</li> <li>Bearings with prefix 5S have ceramic balls.</li> </ul>	112
			2LA-HSE0 5S-2LA-HSE0				135
	Super high-speed		5S-2LA-HSF0	$\phi 50 \sim \phi 100$	25°	<ul style="list-style-type: none"> <li><b>ULTAGE</b> ULTAGE series</li> <li>Maintaining the advantages of HSE type, this type has small diameter ceramic balls to achieve higher speed and limited heat buildup.</li> <li>Bearings with prefix 5S have ceramic balls.</li> </ul>	136 137
	Eco-friendly		5S-2LA-HSL9U	$\phi 50 \sim \phi 170$	20°, 25°	<ul style="list-style-type: none"> <li><b>ULTAGE</b> ULTAGE series</li> <li>These bearings are identical to the HSE and HSF types except in that they are air-oil lubrication designs that have an eco-friendly nozzle.</li> <li>Featuring lower noise, reduced air and oil consumption, they positively improve operating environments and reduce energy consumption.</li> <li>Bearings with prefix 5S have ceramic balls.</li> </ul>	138
			5S-2LA-HSL0				147
			5S-2LA-HSFL0	$\phi 50 \sim \phi 100$	25°		
	HSE with Lubrication hole		5S-2LA-HSEW9U	$\phi 50 \sim \phi 100$	20°, 25°	<ul style="list-style-type: none"> <li><b>ULTAGE</b> ULTAGE series</li> <li>High speed angular contact ball bearings with lubrication hole on outer ring, designed especially for air-oil lubrication based on HSE type. These bearings have an effect on compact design and high rigidity of spindle. Air flow rate and oil consumption can be reduced.</li> <li>Bearings with prefix 5S have ceramic balls.</li> </ul>	148
			5S-2LA-HSEW0				155
	Standard		79 LLB 5S-79 LLB	$\phi 10 \sim \phi 50$	15°, 25°	<ul style="list-style-type: none"> <li><b>ULTAGE</b> ULTAGE series</li> <li>Featuring a two-side non-contact seal design and a special grease, these bearings are a dedicated grease lubricated type that has achieved limited heat buildup through optimization of the interior structure.</li> <li>Bearings with prefix 5S have ceramic balls.</li> </ul>	156
			70 LLB 5S-70 LLB				171
	High-speed		2LA-BNS9 LLB 5S-2LA-BNS9 LLB	$\phi 45 \sim \phi 100$	15°, 20°, 25°	<ul style="list-style-type: none"> <li><b>ULTAGE</b> ULTAGE series</li> <li>Maintaining the advantages of HSE type, this dedicated grease lubricated type has an improved interior design (grease reservoir, both -side non-contact seal and special grease) to extend grease life.</li> <li>Bearings with prefix 5S have ceramic balls.</li> </ul>	172
2LA-BNS0 LLB 5S-2LA-BNS0 LLB			195				
Standard		BNT9 5S-BNT9	$\phi 10 \sim \phi 65$	15°	<ul style="list-style-type: none"> <li>Angular contact ball bearing series for grinding machines/motors.</li> <li>All variants are flush ground.</li> <li>Bearings with prefix 5S have ceramic balls.</li> </ul>	196	
		BNT0 5S-BNT0	$\phi 10 \sim \phi 70$			207	
		BNT2 5S-BNT2	$\phi 10 \sim \phi 80$				
Double-row cylindrical roller bearing		NN49 (K)	$\phi 100 \sim \phi 320$	---	<ul style="list-style-type: none"> <li>The bearing clearance can be either interchangeable radial clearance or non-interchangeable radial clearance.</li> <li>A variant (K) is available with a tapered bore to accommodate a tapered shaft.</li> <li>A bearing type code containing a suffix T6 means an <b>ULTAGE</b> ULTAGE series bearing. Optimized interior structure and resin cage help high speed and positively inhibit temperature rise (applicable to NN30 types with bore diameter of 65 to 130 mm).</li> </ul>	224	
		NN30 (K) NN30HS (K)	$\phi 25 \sim \phi 60$ $\phi 140 \sim \phi 460$				
		NN30HST6 (K) NN30HSRT6 (K)	$\phi 65 \sim \phi 130$				
		NNU49 (K)	$\phi 100 \sim \phi 500$				
						229	

Bearing type	Cross section	Bearing type	Bearing bore mm	Contact angle	Remarks	Page
 Single-row cylindrical roller bearing	Standard	 N10HS (K)	$\phi 30 \sim \phi 160$	—	<ul style="list-style-type: none"> <li>The boundary dimensions of the N10HS(K) high-speed single-row cylindrical roller bearing are the same as those of the N10(K). Only the bearing clearance is non-interchangeable.</li> <li>A ceramic-roller-type (5S-N10) is available on request.</li> </ul>	230 } 233
	High-speed	 N10HSR (K)	$\phi 55 \sim \phi 100$	—	<ul style="list-style-type: none"> <li><b>ULTAGE</b> ULTAGE series</li> <li>Optimized internal design allows higher speed and results in lower temperature rise.</li> <li>The cage is made of a special resin to cope with a high-speed operation.</li> <li>The allowable maximum speed is higher than that of the conventional high-speed cylindrical roller bearing N10HS(K).</li> </ul>	234 } 235
	Eco-friendly	 N10HSL (K)	$\phi 55 \sim \phi 100$	—	<ul style="list-style-type: none"> <li><b>ULTAGE</b> ULTAGE series</li> <li>This is a dedicated air-oil lubricated type identical to the N10HSR(K) type except in that it incorporates an eco-friendly nozzle.</li> <li>Still maintaining the high-speed performance of the N10HSR(K) type, this type boasts lower noise, reduced air and oil consumption, and positively improves operating environments and reduces energy consumption.</li> </ul>	236 } 237
 Plug gage Ring gage Taper gage		<b>Plug gage TA</b>  <b>Ring gage TB</b>	$\phi 30 \sim \phi 160$	—	<ul style="list-style-type: none"> <li>Taper gage for N10-HS(K) single-row cylindrical roller bearing and NN30(K) double-row cylindrical roller bearing.</li> </ul>	238
 Residual internal clearance adjustment gauge		SB	$\phi 35 \sim \phi 160$	—	<ul style="list-style-type: none"> <li>Clearance gage for N10-HSK(K), N10-HSR(K) single-row cylindrical roller bearing and NN30(K), NN30HS(K) double-row cylindrical roller bearing.</li> </ul>	239
 Adjustable preload bearing unit		Adjustable preload bearing unit	—	—	<ul style="list-style-type: none"> <li>Fixed position adjustable preload bearing unit.</li> <li>Incorporation of an adjustable preload sleeve and a duplex angular ball bearing allows the user to adjust the preload of an angular ball bearing in a wider range from a light preload to a heavy preload.</li> <li>Fixed position preload leads to a greater rigidity.</li> </ul>	—
 Double-direction angular contact thrust ball bearing		5629 (M)	Small-size $\phi 100 \sim \phi 320$ Large-size (M) $\phi 104 \sim \phi 330$	60°	<ul style="list-style-type: none"> <li>The small bearing is used on a cylinder bore or smaller-diameter side of a tapered bore of the NN49, NN49 or NN30 double-row cylindrical roller bearing; the large bearing (suffix M) is used on the large hole side of a tapered bore.</li> </ul>	250 } 253
		5620 (M)	Small-size $\phi 25 \sim \phi 320$ Large-size (M) $\phi 27 \sim \phi 330$			
 Angular contact ball bearing for axial load		HTA9U	$\phi 100 \sim \phi 320$	30°, 40°	<ul style="list-style-type: none"> <li><b>ULTAGE</b> ULTAGE series</li> <li>HTA9DB series bearings are fully compatible with 5629 series bearings.</li> </ul>	254 } 265
		HTA0U 5S-HTA0U	$\phi 25 \sim \phi 320$ $\phi 25 \sim \phi 130$			
 Tapered roller bearings		329	$\phi 50 \sim \phi 190$	Nominal contact angle of 10° or greater, 17° or smaller	<ul style="list-style-type: none"> <li>Thin-wall type, ISO-compatible metric series.</li> </ul>	270 } 273
		320	$\phi 20 \sim \phi 170$			

② Ball screw support bearings

Bearing type	Cross section	Bearing type	Bearing bore mm	Contact angle	Remarks	Page
 Angular contact thrust ball bearing for ball screws		<b>BST</b> <b>2A-BST</b> Open type	$\phi 17 \sim \phi 55$	$60^\circ$	<ul style="list-style-type: none"> <li>• <b>ULTAGE</b> ULTAGE series</li> <li>• Surface modification treatment on the bearing ring raceways has led to a longer bearing life and much improved fretting resistance.</li> <li>• Owing to prelubrication with a special grease, the sealed type boasts a longer bearing life and simpler maintenance work.</li> <li>• All variants are flush-ground and are provided with a standard preload.</li> </ul>	290
		<b>BST LXL/L588</b> <b>2A-BST LXL/L588</b> Light-contact sealed type				295
 Ball screw support double row thrust angular contact ball bearing unit		<b>BSTU LXL/L588</b> Light-contact sealed type	$\phi 20 \sim \phi 100$	$60^\circ$	<ul style="list-style-type: none"> <li>• <b>ULTAGE</b> ULTAGE series.</li> <li>• Greater high-load capacity with optimizations made to the internal bearing design.</li> <li>• Use of newly developed light-contact seal to achieve both low torque and high dust resistance.</li> <li>• Long operating life, and use of special grease with high fretting resistance.</li> <li>• Outer ring mounting hole, and sealed grease lubrication groove for easier handling.</li> </ul>	296 } 299
 Angular contact ball bearing for ball screws		<b>HT</b>	$\phi 6 \sim \phi 40$	$30^\circ$	<ul style="list-style-type: none"> <li>• The allowable axial load of this bearing type is greater owing to the improved interior design.</li> </ul>	300 } 301
 Needle roller bearings with double-direction thrust needle roller bearing		<b>AXN</b>	$\phi 20 \sim \phi 50$	—	<ul style="list-style-type: none"> <li>• A clearance remains between the inner ring of radial bearing and the inner rings of both thrust bearings, allowing the user to determine the preload by, for example, tightening a nut etc.</li> <li>• The targeted preload is attained based on the starting torque.</li> <li>• The bearing clearance on certain preloaded bearings is controlled in advance so that an intended preload is attained by fully tightening the inner rings on both thrust bearing with nuts, or equivalent means.</li> </ul>	302 } 303
 Cylindrical roller bearings with double-direction thrust needle roller bearing		<b>ARN</b>	$\phi 20 \sim \phi 70$	—		304 } 305



## 2. Bearing Selection and Shaft & Housing Design

### ① Bearing selection

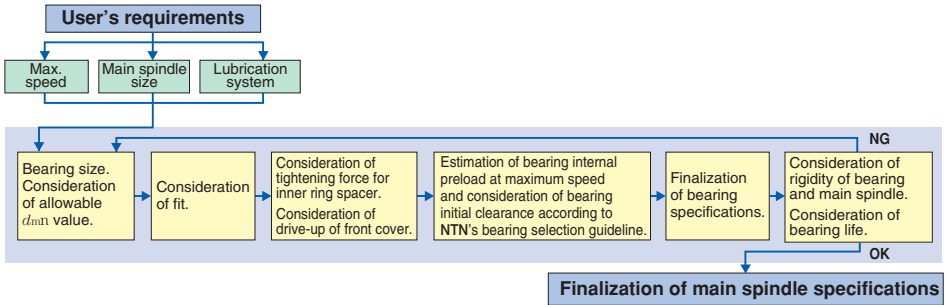
Generally, the optimal bearing must be selected to suit the nature of the machine, the area within the machine, the spindle specification, bearing type, lubrication system and drive system of the intended machine through considerations of the design life,

precision, rigidity and critical speed, etc. of the bearing. **Table 2.1** summarizes a typical bearing selection procedure, and **Table 2.2** gives an example flowchart according to which considerations are made to select an optimal main spindle bearing for a machine tool.

**Table 2.1** Bearing selection procedure

Step	Items being considered	Items being confirmed
Confirm operating conditions of bearing and consider bearing type.	<ul style="list-style-type: none"> <li>Function and construction of components to house bearings</li> <li>Bearing mounting location</li> <li>Dimensional limitations</li> <li>Magnitude and direction of bearing load</li> <li>Magnitude of vibration and shock load</li> <li>Shaft speed</li> <li>Bearing arrangement (fixed side, floating side)</li> </ul>	<ul style="list-style-type: none"> <li>Noise and torque of the bearing</li> <li>Bearing operating temperature range</li> <li>Bearing rigidity</li> <li>Installation / disassembly requirements</li> <li>Maintenance and inspection</li> <li>Cost-effectiveness</li> <li>Allowable misalignment of inner/outer rings</li> </ul>
Determine bearing type and arrangement.		
Select bearing dimensions.	<ul style="list-style-type: none"> <li>Design life of components to house bearings</li> <li>Dynamic/static equivalent load conditions</li> </ul>	<ul style="list-style-type: none"> <li>Safety factor <math>S_o</math></li> <li>Allowable speed</li> <li>Allowable axial load</li> </ul>
Determine bearing dimensions.		
Select bearing tolerances.	<ul style="list-style-type: none"> <li>Shaft runout tolerances</li> <li>Torque fluctuation</li> </ul>	<ul style="list-style-type: none"> <li>High-speed operation</li> </ul>
Decide bearing grade.		
Select bearing internal clearance.	<ul style="list-style-type: none"> <li>Material and shape of shaft and housing</li> <li>Fit</li> <li>Temperature difference between inner and outer rings</li> </ul>	<ul style="list-style-type: none"> <li>Allowable misalignment of inner/outer rings</li> <li>Magnitude and nature of load</li> <li>Amount of preload</li> </ul>
Decide bearing internal clearance.		
Select cage.	<ul style="list-style-type: none"> <li>Rotational speed</li> <li>Noise level</li> </ul>	<ul style="list-style-type: none"> <li>Vibration and shock load</li> <li>Lubrication</li> </ul>
Cage type		
Select lubrication method.	<ul style="list-style-type: none"> <li>Operating temperature</li> <li>Rotational speed</li> <li>Lubrication method</li> </ul>	<ul style="list-style-type: none"> <li>Sealing method</li> <li>Maintenance and inspection</li> </ul>
Decide lubrication method, lubricant, and sealing method.		
Consider special specifications.	<ul style="list-style-type: none"> <li>Operating conditions (special environments: high or low temperature, chemical)</li> <li>Requirement for high reliability</li> </ul>	
Decide special bearing specifications.		
Select installation and disassembly procedures.	<ul style="list-style-type: none"> <li>Mounting dimensions</li> </ul>	<ul style="list-style-type: none"> <li>Installation and disassembly procedures</li> </ul>
Decide installation and disassembly procedures.		

**Table 2.2 Bearing selection procedure**



The articles necessary for basic considerations in selecting an optimal main spindle bearing for machine tool are summarized in **Table 2.3**.

**Table 2.3 Selection procedure for bearings for main spindles of machine tools**

(1) Type of Machine	NC Lathe, machining center, grinding machine, etc.
(2) Main spindle orientation	Vertical, horizontal, variable-direction, inclined, etc.
(3) Diameter and size of main spindle	#30, #40, #50, etc.
(4) Shape and mounting-related dimensions of main spindle	<p style="text-align: center;"><b>Fig. 2.1 Main spindle shape and mounting-related dimensions (example)</b></p>
(5) Intended bearing type, bearing size, and preloading method	Front (angular contact type, cylindrical roller type) or rear (angular contact type, cylindrical roller type) preloading system (fixed-position preloading, fixed-pressure preloading)
(6) Slide system free side	Cylindrical roller bearing, ball bushing (availability of cooling)
(7) Lubrication method	Grease, air-oil, oil mist (MicronLub)
(8) Drive system	Built-in motor, belt drive, coupling
(9) Presence/absence of jacket cooling arrangement on bearing area	Yes/No
(10) Jacket cooling conditions	Synchronization with room temperature, machine-to-machine synchronization, oil feed rate (L/min)
(11) Operating speed range	Max. speed (min <sup>-1</sup> )
	Normal speed range (min <sup>-1</sup> )
	Operating speed range (min <sup>-1</sup> )
(12) Load conditions (machining conditions)	Load center
	Applied load Radial load $F_r$ (N) Axial load $F_a$ (N)
	Speed
	Machining frequency
	Intended bearing life

## ② Bearing accuracy

### ■ Bearing accuracy

Accuracies of rolling bearings, that is, dimensional accuracy and running accuracy of rolling bearings are defined by applicable ISO standards and JIS B 1514 standard (Rolling bearings - Tolerances) (**Tables 2.4** and **2.5**). The dimensional accuracy governs the tolerances that must be satisfied when mounting a bearing to a shaft or housing, while the running

accuracy defines a permissible run-out occurring when rotating a bearing by one revolution. Methods for measuring the accuracy of rolling bearings (optional methods) are described in JIS B 1515 (Measuring methods for rolling bearings). **Table 2.6** summarizes some typical methods for measuring running accuracy of rolling bearings.

**Table 2.4 Bearing types and applicable tolerance**

Bearing type		Applicable standard	Tolerance class				
Angular contact ball bearings		JIS B 1514 (ISO492)	Class 0	Class 6	Class 5	Class 4	Class 2
Cylindrical roller bearings			Class 0	class 6	Class 5	Class 4	Class 2
Needle roller bearings			Class 0	class 6	Class 5	Class 4	—
Tapered roller bearings	Metric	JIS B 1514	Class 0,6X	class 6	Class 5	Class 4	—
	Inch	ANSI/ABMA Std.19	Class 4	Class 2	Class 3	Class 0	Class 00
	J series	ANSI/ABMA Std.19.1	Class K	Class N	Class C	Class B	Class A
Double row angular contact thrust ball bearings		NTN standard	—	—	Class 5	Class 4	—

**Table 2.5. Comparison of tolerance classifications of national standards**

Standard	Applicable standard	Tolerance Class					Bearing Types
Japanese industrial standard (JIS)	JIS B 1514	Class 0,6X	Class 6	Class 5	Class 4	Class 2	All type
International Organization for Standardization (ISO)	ISO 492	Normal class Class 6X	Class 6	Class 5	Class 4	Class 2	Radial bearings
	ISO 199	Normal Class	Class 6	Class 5	Class 4	—	Thrust ball bearings
	ISO 578	Class 4	—	Class 3	Class 0	Class 00	Tapered roller bearings (Inch series)
	ISO 1224	—	—	Class 5A	Class 4A	—	Precision instrument bearings
Deutsches Institut für Normung(DIN)	DIN 620	P0	P6	P5	P4	P2	All type
American National Standards Institute (ANSI)	ANSI/ABMA Std.20 <sup>①</sup>	ABEC-1 RBEC-1	ABEC-3 RBEC-3	ABEC-5 RBEC-5	ABEC-7	ABEC-9	Radial bearings (Except tapered roller bearings)
American Bearing Manufacturer's Association (ABMA)	ANSI/ABMA Std.19.1	Class K	Class N	Class C	Class B	Class A	Tapered roller bearings (Metric series)
	ANSI/ABMA Std.19	Class 4	Class 2	Class 3	Class 0	Class 00	Tapered roller bearings (Inch series)

① "ABEC" is applied for ball bearings and "RBEC" for roller bearings.

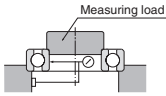
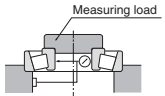
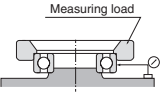
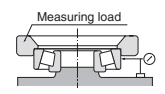
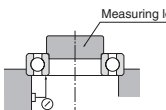
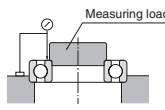
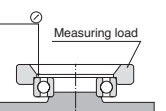
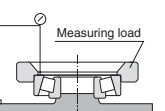
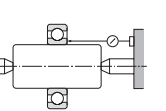
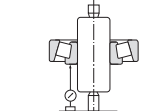
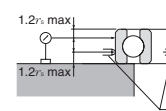
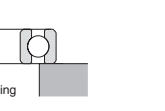
Notes 1: JIS B 1514, ISO 492 and 199, and DIN 620 have the same specification level.

2: The tolerance and allowance of JIS B 1514 are slightly different from those of ABMA standards.

To attain a higher level of running accuracy required of a main spindle of machine tool, a high-precision bearing that satisfies the user's main spindle specifications must be chosen. Usually, a high-precision bearing per JIS accuracy class 5, 4 or 2 is selected according to an intended application. In particular, the radial run-out, axial run-out and non-repetitive run-out of a main spindle bearing greatly affect the running accuracy of the main spindle and therefore have to be strictly controlled. With the recent super high-precision machine tools, the control of N.R.R.O. (Non-Repetitive Run-Out) has increasing

importance, and the main spindle on a turning machine or machining center incorporates an N.R.R.O. accuracy controlled bearing. For further information about N.R.R.O., refer to the following section. Note that to attain a higher accuracy with a main spindle, careful considerations need to be exercised for the accuracies (circularity, cylindricity, coaxiality) of machine components other than a bearing (shaft, housing) as well as machining method and finish accuracy of the shaft and housing. For the information about the accuracies of shaft and housing, refer to a section given later.

Table 2.6 Measuring methods for running accuracies

Characteristic tolerance	Measurement method	
Inner ring radial runout ( $K_{ia}$ )		 <p data-bbox="777 592 997 699">Radial runout of the inner ring is the difference between the maximum and minimum reading of the measuring device when the inner ring is turned one revolution.</p>
Outer ring radial runout ( $K_{oa}$ )		 <p data-bbox="777 740 997 847">Radial runout of the outer ring is the difference between the maximum and minimum reading of the measuring device when the outer ring is turned one revolution.</p>
Inner ring axial runout ( $S_{ia}$ )		 <p data-bbox="777 888 997 995">Axial runout of the inner ring is the difference between the maximum and minimum reading of the measuring device when the inner ring is turned one revolution.</p>
Outer ring axial runout ( $S_{oa}$ )		 <p data-bbox="777 1037 997 1144">Axial runout of the outer ring is the difference between the maximum and minimum reading of the measuring device when the outer ring is turned one revolution.</p>
Inner ring side runout with bore ( $S_d$ )		 <p data-bbox="777 1185 997 1313">Inner ring side runout with bore is the difference between the maximum and minimum reading of the measuring device when the inner ring is turned one revolution together with the tapered mandrel.</p>
Outer ring outside surface inclination ( $S_b$ )		 <p data-bbox="777 1353 997 1481">Outer ring outside surface inclination is the difference between the maximum and minimum reading of the measuring device when the outside ring is turned one revolution along the reinforcing plate.</p>

**■N.R.R.O. (Non-Repetitive Run-Out) of bearing**

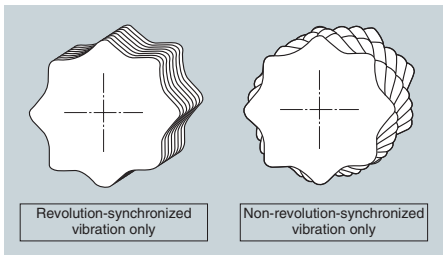
Accuracies of rolling bearings are defined by applicable ISO standards and a JIS (Japanese Industrial Standard) standard, wherein the accuracies are discussed under the descriptions of radial run-out ( $K_{ra}$ ), axial run-out ( $S_{ia}$ ), etc. According to the methods for measuring running accuracies in **Table 2.6**, run-out is read by turning a bearing by only one revolution (each reading is synchronized with the revolution of the bearing being analyzed).

In fact, however, a rolling bearing for machine tool is used in a continuous revolving motion that involves more than one revolution. As a result, the actual run-out accuracy with a rolling bearing includes elements that are not synchronous with the revolution of the bearing (for example, a difference in diameter among rolling elements involved, as well as roundness on the raceway surfaces of inner ring and outer ring), causing the trajectory of plotting with running accuracies to vary with each revolution.

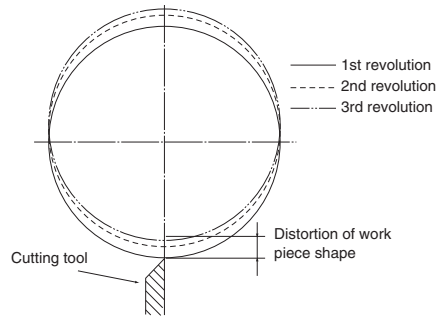
The run-out of an element not in synchronization with the revolutions of bearing is known as N.R.R.O. (Non-Repetitive Run-Out) and is equivalent to the amplitude in the Lissajous figure illustrated in **Fig. 2.3**.

The effect of N.R.R.O. on a rolling bearing onto the accuracies is illustrated in **Fig. 2.4** by taking a main spindle of turning machine as an example.

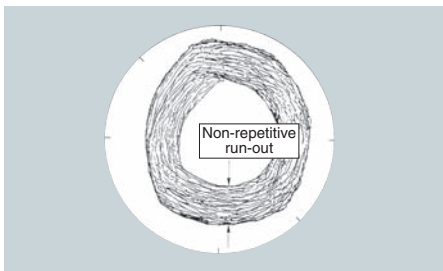
This diagram illustrates a machining process where the outside surface of a work piece mounted to the main spindle is shaved by a turning operation. If the outside surface is cut with a new trajectory with every revolution, the outside shape of work piece will be distorted. Furthermore, if the accuracies of shaft and housing are not high enough or bearings are assembled onto the shaft and/or housing improperly, the bearing ring can be deformed, possibly leading to a run-out that is not in synchronization with the revolutions of bearing.



**Fig. 2.2**



**Fig. 2.4 Model of cutting operation**



**Fig. 2.3 Lissajous figure**

### Accuracies of shaft and housing

Depending on the fit of a bearing to a shaft and a housing, the bearing internal clearance can vary. For this reason, an adequate bearing fit has to be attained so that the bearing can perform as designed. (Refer to the recommended fit section.)

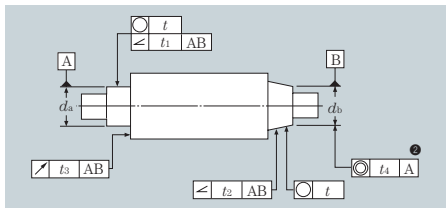
Also, the axial tightening torque on a bearing needs to be considered. To avoid deformation of bearing raceway surface owing to axial tightening of the bearing, it is necessary to carefully determine the dimensions of components associated with a tightening force the magnitude of tightening force and the number of tightening bolts.

The clearance on a tapered bore cylindrical roller bearing is adjusted by changing the drive-up to the taper. Because of this, the critical factors associated with an appropriate fit of a bearing to a shaft and/or a housing are the dimensional accuracies of the taper, contact surface on the taper, and the squareness of the end face of the inner ring relative to the shaft centerline during the drive-up process.

Typical accuracy values for a spindle and housing are summarized in Tables 2.7 and 2.8.

### Typical accuracy for spindle

Table 2.7 Form accuracy of spindle ①

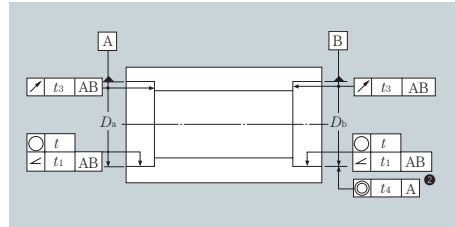


Accuracy	Symbol	Tolerance <sup>①</sup>	Fundamental permissible tolerance IT		
			P5	P4	P2
Deviation from circular form	○	<i>t</i>	$\frac{IT3}{2}$	$\frac{IT2}{2}$	$\frac{IT0}{2}$ ②
Angularity	∠	<i>t</i> <sub>1</sub>	$\frac{IT3}{2}$	$\frac{IT2}{2}$	$\frac{IT0}{2}$ ②
	∠	<i>t</i> <sub>2</sub>	—	$\frac{IT3}{2}$	$\frac{IT2}{2}$
Run out	↗	<i>t</i> <sub>3</sub>	IT3	IT3	IT2
Eccentricity	◎	<i>t</i> <sub>4</sub>	IT5	IT4	IT3

- ① The form tolerance, symbol, and reference face of spindle are in accordance with ISO R1101.
- ② The length of the bearing fit surface is often too small to measure concentricity. Therefore, this criterion applies only when the fit surface has a width sufficient as a reference face.
- ③ When determining a tolerance for permissible form accuracy, the reference dimensions used are shaft diameters *d<sub>a</sub>* and *d<sub>b</sub>*.  
For example, when using a JIS class 5 bearing for a dia. 50 mm shaft, the tolerance of roundness is  $t = IT3/2 = 4/2 = 2 \mu\text{m}$ .
- ④ IT0 is preferred if the diameter tolerance of the bearing fit surface is IT3.

### Typical accuracy for housing

Table 2.8 Form accuracy of housing ①



Accuracy	Symbol	Tolerance <sup>①</sup>	Fundamental permissible tolerance IT		
			P5	P4	P2
Deviation from circular form	○	<i>t</i>	$\frac{IT3}{2}$	$\frac{IT2}{2}$	$\frac{IT1}{2}$
Angularity	∠	<i>t</i> <sub>1</sub>	$\frac{IT3}{2}$	$\frac{IT2}{2}$	$\frac{IT1}{2}$
Run out	↗	<i>t</i> <sub>3</sub>	IT3	IT3	IT2
Eccentricity	◎	<i>t</i> <sub>4</sub>	IT5	IT4	IT3

- ① The form tolerance, symbol and reference face of the housing are in accordance with ISO R1101.
- ② The length of the bearing fit surface is often too small to measure concentricity. Therefore, this criterion applies only when the fit surface has a width sufficient as a reference face.
- ③ Housing bore diameters *D<sub>a</sub>* and *D<sub>b</sub>* are the reference dimensions used when the tolerance for permissible form accuracy are determined.  
For example, when a JIS class 5 bearing is used for a housing with a 50 mm inside bore, the tolerance of roundness is  $t = IT3/2 = 5/2 = 2.5 \mu\text{m}$ .

### Fundamental tolerance IT

Table 2.9 Fundamental tolerance IT

Classification of nominal dimension mm		Fundamental tolerance IT value $\mu\text{m}$						
over	incl.	IT0	IT1	IT2	IT3	IT4	IT5	
6	10	0.6	1	1.5	2.5	4	6	
10	18	0.8	1.2	2	3	5	8	
18	30	1	1.5	2.5	4	6	9	
30	50	1	1.5	2.5	4	7	11	
50	80	1.2	2	3	5	8	13	
80	120	1.5	2.5	4	6	10	15	
120	180	2	3.5	5	8	12	18	
180	250	3	4.5	7	10	14	20	
250	315	4	6	8	12	16	23	
315	400	5	7	9	13	18	25	
400	500	6	8	10	15	20	27	

Note) For machine tool spindles, the shaft hardness is recommended to be at least HRC50 and the housing is recommended to be at least HRC30 to assist bearing replacement during repairs.

### ③ Bearings and rigidity

The rigidity of the main spindle of a machine tool is associated with both bearing rigidity and shaft rigidity. Bearing rigidity is typically governed by the elastic deformation between the rolling elements and raceway surface under load. Usually, bearings are preloaded in order to increase the rigidity.

Under same loading conditions, a roller bearing has a higher rigidity than a ball bearing of the same size. However, having sliding portions, a roller bearing is disadvantageous in supporting a high-speed shaft.

Shaft rigidity is greater with a larger shaft diameter. However, the supporting bearing must have a sufficient size and its  $d_{m1}$  value (pitch center diameter across rolling elements  $d_m$  [mm] multiplied by speed [ $\text{min}^{-1}$ ]) must be accordingly greater. Of course, a larger bearing is disadvantageous for high-speed applications.

To sum up, the rigidity required of the shaft arrangement must be considered before the bearing rigidity (bearing type and preload) and shaft rigidity are determined.

#### ■Bearings rigidity

The rigidity of a bearing built into a spindle directly affects the rigidity of the spindle.

In particular, a high degree of rigidity is required of the main spindle of a machine tool to ensure adequate productivity and accurate finish of workpieces.

**Bearing rigidity is governed by factors such as the following:**

- (1) Types of rolling elements
- (2) Size and quantity of rolling elements
- (3) Material of rolling elements
- (4) Bearing contact angle
- (5) Preload on bearing

#### ■Type of rolling elements (roller or ball)

The surface contact pattern of the rolling element and raceway is line contact with a roller bearing, while a ball bearing is point contact. As a result, the dynamic deformation of a bearing relative to a given load is smaller with a roller bearing.

#### ■Size and number of rolling elements

The size and number of rolling elements of a bearing are determined based on the targeted performance of the bearing.

Larger rolling elements lead to a greater bearing rigidity. However, a bearing having larger rolling elements tends to be affected by gyratory sliding centrifugal force, and, as a result, its high-speed performance will be degraded. Incidentally, a greater number of rolling elements helps increase bearing rigidity, but at the same time creates an increased number of heat generation sources, possibly leading to greater temperature rise.

For this reason, smaller size of rolling elements are used for high-speed applications.

To achieve both "high speed" and "high rigidity", each type of the NTN angular contact ball bearing for a machine tool is manufactured according to optimized specifications for interior structure.

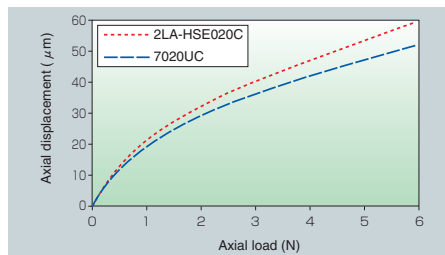


Fig. 2.5

#### ■Material of rolling element (ceramic and steel)

Certain NTN bearings incorporate ceramic rolling elements. As Young's modulus of silicon nitride (315 GPa) is greater than that of bearing steel (210 GPa), the rigidity with this type of bearing is accordingly greater.

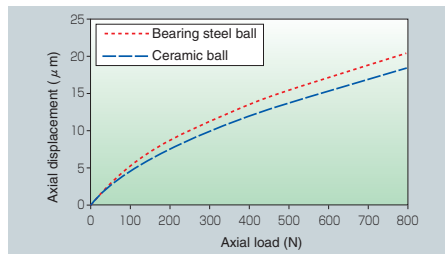


Fig. 2.6

#### ■Bearing contact angle

A smaller contact angle on an angular contact ball bearing results in greater radial rigidity. When used as a thrust bearing, this type of bearing should have a greater contact angle to enable greater axial rigidity.

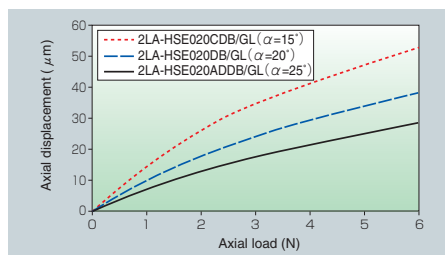


Fig. 2.7

**Preload on bearing**

A greater preload on a given bearing results in greater rigidity (Fig. 2.8). However, too great of a preload on a bearing can lead to overheating, seizure, and/or premature wear of the bearing. It is possible to use bearings in three- or four-row configurations in order to achieve increased axial rigidity (Fig. 2.9).

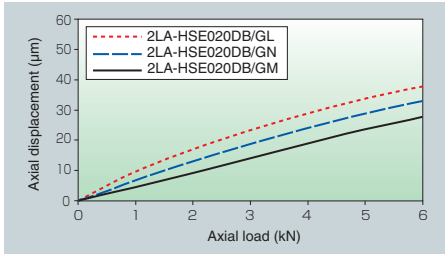


Fig. 2.8

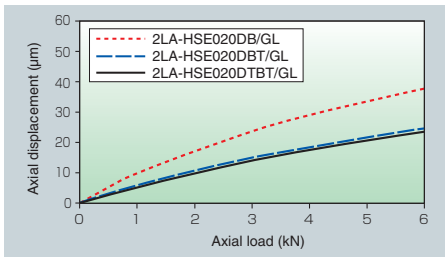


Fig. 2.9

**Preloading technique and preload**

Bearing preloading techniques can be categorized as definite position preloading and constant pressure preloading (Fig. 2.10).

Definite position preloading is useful in enhancing the rigidity of a bearing unit, as the positional relationship across individual bearings can be maintained. On the other hand, as preloading is achieved with spring force, the constant pressure preloading technique can maintain a preload constant even when the bearing-to-bearing distance varies due to heat generation on the spindle or a change in load.

The basic preload for a duplex bearing is given in the relevant section for each bearing.

If an angular contact ball bearing is to be used for a high-speed application, such as for the main spindle of a machine tool, determine the optimal preload by considering the increase in contact surface pressure between rolling elements and the raceway surface that results from gyratory sliding and centrifugal force. When considering such an application, consult NTN Engineering.

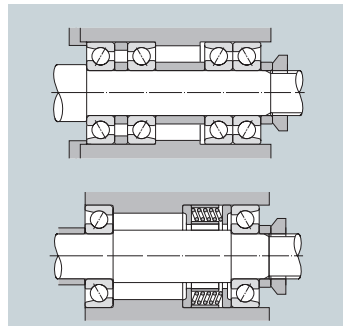


Fig. 2.10

**Preload and rigidity**

The effect of preloading for an increase in bearing rigidity is summarized in Fig. 2.11.

When the inner rings in the diagram are tightened to bring them together, bearings I and II are each axially displaced by dimension  $\delta_o$ , thereby attaining a preload  $F_o$ . In this situation, if an axial load  $F_a$  is further exerted from outside, the displacement on bearing I increases

by  $\delta_a$ , while the displacement on bearing II decreases.

At this point, the loads on bearings I and II are  $F_I$  and  $F_{II}$ , respectively. When compared with  $\delta_b$  (the displacement occurring when an axial load  $F_a$  is exerted onto a non-preloaded bearing I), displacement  $\delta_a$  is small. Thus, a preloaded bearing has higher rigidity.

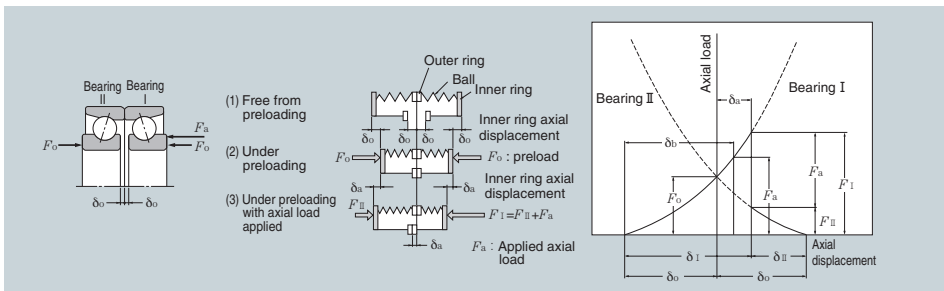


Fig. 2.11 Preload graph



**Gyratory sliding**

Every rolling element (ball) in an angular contact ball bearing revolves on the axis of rotation A-A' as illustrated in Fig. 2.12. A revolving object tends to force the axis of rotation to a vertical or horizontal attitude. As a result, the rolling element develops a force to alter the orientation of the axis of rotation. This force is known as a gyratory moment (M).

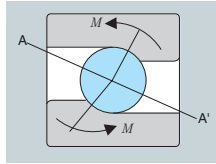


Fig. 2.12 Gyratory sliding

When the force due to the gyratory moment is greater than the resistance force (rolling element load multiplied by the coefficient of friction between the raceway and rolling element), gyratory sliding occurs on the raceway surface. This leads to heat generation, wear and seizure. Therefore, it is necessary to provide a sufficient resistance force to inhibit gyratory sliding. NTN's recommended preload is based on this theory.

The gyratory moment that will occur can be calculated by the formula below.

$$M = k \times \omega_b \times \omega_c \times \sin \beta$$

$$k = \frac{1}{10} \times m \times d_w^2 = 0.45 \times \rho \times d_w^5$$

$$M \propto d_w^5 \times n^2 \times \sin \beta$$

$M$  : Gyratory moment  
 $\omega_b$  : Autorotation angular velocity of rolling element  
 $\omega_c$  : Angular velocity of revolution  
 $m$  : Mass of rolling element  
 $\rho$  : Density of rolling element  
 $d_w$  : Diameter of rolling element  
 $\beta$  : Angle of axis of rotation of rolling element  
 $n$  : Speed of inner ring

**Spin sliding**

Every rolling element (ball) in an angular contact ball bearing develops spin sliding that is unavoidable owing to the structure of the bearing, relative to the raceway surface of either the inner ring or outer ring (Fig. 2.13).

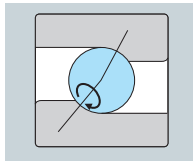


Fig. 2.13 Spin sliding

Usually, at a lower speed range, pure rolling motion occurs between an inner ring raceway and rolling elements and spin sliding develops between an outer ring raceway and rolling elements (this state is known as inner ring control). At a higher speed range, pure rolling motion occurs between an outer ring raceway and rolling elements and spin sliding develops between an inner ring raceway and rolling elements (this state is known as outer ring control). A point where transfer from inner ring control to outer ring control occurs is known as control transfer point. An amount of spin sliding and control transfer point can vary depending on the bearing type and bearing data. Generally, the amount of spin sliding will be greater with an outer ring control state.

According to J. H. Rumbarger and J. D. Dunfee, when the amount of spin sliding exceeds  $4.20 \times 10^6$  (N/m<sup>2</sup>·mm/s), increase of heat generation and wear start.

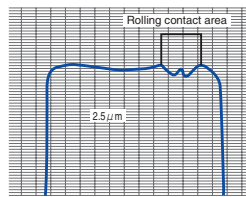
Generally, it is necessary for a bearing of a high-speed main spindle to have a preload that can prevent spin sliding.

The example of wear on a bearing owing to spin sliding is given in Fig. 2.14.

The magnitude of spin-derived wear is governed by a PV value (amount of spin sliding) during operation of the main spindle. Therefore, the optimum bearing for main spindle must be selected. Though the possibility of spin-derived wear occurrence varies depending on the bearing type, model number and specifications, we carefully determined a control transfer point in an operating arrangement for NTN angular contact ball bearings for main spindles of machine tools. Thus, we believe that the amount of spin sliding with this bearing category is not very large.

Additionally, the magnitude of spin-derived wear is significantly affected by how well the raceway surface is lubricated. Regardless of the type of sliding, even minor sliding can lead to wear if oil film is not formed well. For this reason, a reliable lubrication arrangement needs to be incorporated.

The form of wear on the bearing raceway derived from spin sliding appears as . The wear on the raceway surface on inner ring that resulted from spin sliding is given below.



Bearing: 7026T1  
 Thrust load: 2 kN  
 Speed: 5000 min<sup>-1</sup>  
 Lubrication: Grease  
 Run time: 50 h

Possible causes for type wear

- (1) Contact ellipse and direction of spin sliding
- (2) Sliding velocity (V)
- (3) Bearing pressure within ellipse (P)
- (4) PV value owing to spin
- (5) Wear on raceway surface

**2.14 Mechanism of wear on bearing owing to spin sliding**

### ④ Designing shaft and housing

In designing a bearing and housing, it is very important to provide a sufficient shoulder height for the bearing and housing so as to maintain bearing and housing accuracies and to avoid interference with the bearing related corner radius.

The chamfer dimensions are shown in **Table 2.10** and the recommended shoulder height and corner radii on the shaft and housing are listed in **Table 2.11**.

### ■ Bearing corner radius dimensions

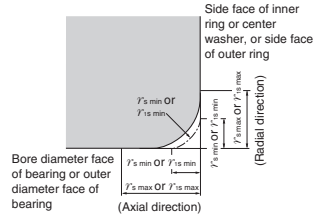


Fig. 2.15

Table 2.10 Allowable critical-value of bearing chamfer

(1) Radial bearings (Except tapered roller bearings)

r's min <sup>①</sup> or r's min		Nominal bore diameter		r's max OF r's max	
		over	incl.	Radial direction	Axial direction
0.05	—	—	—	0.1	0.2
0.08	—	—	—	0.16	0.3
0.1	—	—	—	0.2	0.4
0.15	—	—	—	0.3	0.6
0.2	—	—	—	0.5	0.8
0.3	—	40	—	0.6	1
	40	—	—	0.8	1
0.6	—	40	—	1	2
	40	—	—	1.3	2
1	—	50	—	1.5	3
	50	—	—	1.9	3
1.1	—	120	—	2	3.5
	120	—	—	2.5	4
1.5	—	120	—	2.3	4
	120	—	—	3	5
2	—	80	—	3	4.5
	80	220	—	3.5	5
	220	—	—	3.8	6
2.1	—	280	—	4	6.5
	280	—	—	4.5	7
2.5	—	100	—	3.8	6
	100	280	—	4.5	6
	280	—	—	5	7
3	—	280	—	5	8
	280	—	—	5.5	8
4	—	—	—	6.5	9
5	—	—	—	8	10
6	—	—	—	10	13
7.5	—	—	—	12.5	17
9.5	—	—	—	15	19
12	—	—	—	18	24
15	—	—	—	21	30
19	—	—	—	25	38

① These are the allowable minimum dimensions of the chamfer dimension "r" or "r1" and are described in the dimensional table.

(2) Metric tapered roller bearings

r's min <sup>①</sup> or r's min		Nominal bore diameter of bearing "d" or nominal outside diameter "D"		r's max OF r's max	
		over	incl.	Radial direction	Axial direction
0.3	—	40	—	0.7	1.4
	40	—	—	0.9	1.6
0.6	—	40	—	1.1	1.7
	40	—	—	1.3	2
1	—	50	—	1.6	2.5
	50	—	—	1.9	3
1.5	—	120	—	2.3	3
	120	250	—	2.8	3.5
	250	—	—	3.5	4
2	—	120	—	2.8	4
	120	250	—	3.5	4.5
	250	—	—	4	5
2.5	—	120	—	3.5	5
	120	250	—	4	5.5
	250	—	—	4.5	6
3	—	120	—	4	5.5
	120	250	—	4.5	6.5
	250	400	—	5	7
	400	—	—	5.5	7.5
	—	120	—	5	7
4	120	250	—	5.5	7.5
	250	400	—	6	8
	400	—	—	6.5	8.5
	—	180	—	6.5	8
5	180	—	—	7.5	9
	—	180	—	7.5	10
6	180	—	—	9	11

② These are the allowable minimum dimensions of the chamfer dimension "r" or "r1" and are described in the dimensional table.

③ Inner rings shall be in accordance with the division of "d" and outer rings with that of "D".

Note: This standard will be applied to bearings whose dimensional series (refer to the dimensional table) are specified in the standard of ISO 355 or JIS B 1512. For further information concerning bearings outside of these standards or tapered roller bearings using US customary units, please contact NTN Engineering.

(3) Thrust bearings

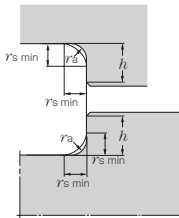
r's min or r's min <sup>①</sup>	r's max OF r's max Radial and axial direction
0.05	0.1
0.08	0.16
0.1	0.2
0.15	0.3
0.2	0.5
0.3	0.8
0.6	1.5
1	2.2
1.1	2.7
1.5	3.5
2	4
2.1	4.5
3	5.5
4	6.5
5	8
6	10
7.5	12.5
9.5	15
12	18
15	21
19	25

④ These are the allowable minimum dimensions of the chamfer dimension "r" or "r1" and are described in the dimensional table.

**Abutment height and fillet radius**

The shaft and housing abutment height ( $h$ ) should be larger than the bearing's maximum allowable chamfer dimensions ( $r_{s\ max}$ ), and the abutment should be designed so that it directly contacts the flat part of the bearing end face. The fillet radius ( $r_a$ ) must be smaller than the bearing's minimum allowable chamfer dimension ( $r_{s\ min}$ ) so that it does not interfere with bearing seating. **Table 2.11** lists abutment height ( $h$ ) and fillet radius ( $r_a$ ).

For bearings that support very large axial loads, shaft abutments ( $h$ ) should be higher than the values in the table.



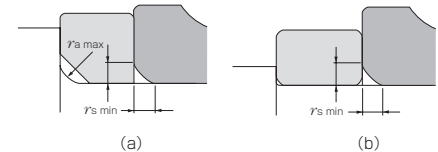
**Table 2.11 Fillet radius and abutment height**

Unit mm

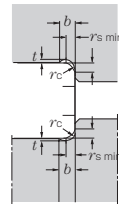
Chamfer length	Fillet radius (radius)	Shoulder height $h$ (min)
$r_{s\ min}$ Or $r_{s\ max}$	$r_{a\ max}$	Normal use <sup>①</sup>
0.05	0.05	0.3
0.08	0.08	0.3
0.1	0.1	0.4
0.15	0.15	0.6
0.2	0.2	0.8
0.3	0.3	1.25
0.6	0.6	2.25
1	1	2.75
1.1	1	3.5
1.5	1.5	4.25
2	2	5
2.1	2	6
2.5	2	6
3	2.5	7
4	3	9
5	4	11
6	5	14
7.5	6	18
9.5	8	22
12	10	27
15	12	32
19	15	42

① If bearing supports large axial load, the height of the shoulder must exceed the value given here.

Note:  $r_{a\ max}$  maximum allowable fillet radius.



**Fig. 2.16 Bearing mounting with spacer**



**2.12 Relief dimensions for grinding**

$r_{s\ min}$	Relief dimensions		
	$b$	$t$	$r_c$
1	2	0.2	1.3
1.1	2.4	0.3	1.5
1.5	3.2	0.4	2
2	4	0.5	2.5
2.1	4	0.5	2.5
2.5	4	0.5	2.5
3	4.7	0.5	3
4	5.9	0.5	4
5	7.4	0.6	5
6	8.6	0.6	6
7.5	10	0.6	7

### 3. Load Rating and Life

#### ① Bearing life

Even in bearings operating under normal conditions, the surfaces of the raceway and rolling elements are constantly being subjected to repeated compressive stresses which causes flaking of these surfaces to occur. This flaking is due to material fatigue and will eventually cause the bearings to fail. The effective life of a bearing is usually defined in terms of the total number of revolutions a bearing can undergo before flaking of either the raceway surface or the rolling element surfaces occurs.

Other causes of bearing failure are often attributed to problems such as seizure, abrasions, cracking, chipping, scuffing, rust, etc. However, these so called "causes" of bearing failure are usually caused by improper installation, insufficient or improper lubrication, faulty sealing or improper bearing selection. Since the above mentioned "causes" of bearing failure can be avoided by taking the proper precautions, and are not simply caused by material fatigue, they are considered separately from the flaking aspect.

Usually, the load exerted on the main spindle of a machine tool is relatively small compared to the dynamic rated load on the bearing. Therefore, the fatigue life of a bearing seldom poses a problem.

The following operating conditions, rather than a bearing's rating life, can significantly affect the bearing functions (running accuracy, rigidity, heat generation, etc.) and require special consideration.

- (1) High speed operation.
- (2) Heavy preload.
- (3) Large bending of the shaft.
- (4) Large temperature difference between the inner and outer rings.

For further information, please consult NTN Engineering.

#### ■ Basic rating life and basic dynamic load rating

A group of seemingly identical bearings when subjected to identical load and operating conditions will exhibit a wide diversity in their durability.

This "life" disparity can be accounted for by the difference in the fatigue of the bearing material itself. This disparity is considered statistically when calculating bearing life, and the basic rating life is defined as follows.

The basic rating life is based on a 90% statistical model which is expressed as the total number of revolutions 90% of the bearings in an identical group of bearings subjected to identical operating conditions will attain or surpass before flaking due to material fatigue

occurs. For bearings operating at fixed constant speeds, the basic rating life (90% reliability) is expressed in the total number of hours of operation.

Basic dynamic load rating expresses a rolling bearing's capacity to support a dynamic load. The basic dynamic load rating is the load under which the basic rating life of the bearing is 1 million revolutions. This is expressed as pure radial load for radial bearings and pure axial load for thrust bearings. These are referred to as "basic dynamic load rating ( $C_r$ )" and "basic dynamic axial load rating ( $C_a$ ).". The basic dynamic load ratings given in the bearing tables of this catalog are for bearings constructed of NTN standard bearing materials, using standard manufacturing techniques.

The relationship between the basic rating life, the basic dynamic load rating and the bearing load is given in the formula below.

For ball bearings:  $L_{10} = \left(\frac{C}{P}\right)^3 \dots\dots\dots (3.1)$

$$L_{10h} = \frac{10^6}{60n} \left(\frac{C}{P}\right)^3 \dots\dots\dots (3.2)$$

For roller bearings:  $L_{10} = \left(\frac{C}{P}\right)^{10/3} \dots\dots\dots (3.3)$

$$L_{10h} = \frac{10^6}{60n} \left(\frac{C}{P}\right)^{10/3} \dots\dots\dots (3.4)$$

where,

- $L_{10}$  : Basic rating life,  $10^6$  revolutions
- $L_{10h}$  : Basic rating life, h
- $C$  : Basic dynamic load rating, N (kgf)  
( $C_r$ : radial bearings,  $C_a$ : thrust bearings)
- $P$  : Equivalent dynamic load, N (kgf)  
( $P_r$ : radial bearings,  $P_a$ : thrust bearings)
- $n$  : Rotational speed,  $\text{min}^{-1}$

When several bearings are incorporated in machines or equipment as complete units, all the bearings in the unit are considered as a whole when computing bearing life (see formula 3.5).

$$L = \frac{1}{\left(\frac{1}{L_1^e} + \frac{1}{L_2^e} + \dots + \frac{1}{L_n^e}\right)^{1/e}} \dots\dots\dots (3.5)$$

where,

- $L$  : Total basic rating life of entire unit, h
- $L_1, L_2 \dots L_n$ : Basic rating life of individual bearings, 1, 2, ... n, h
- $e = 10/9 \dots\dots\dots$  For ball bearings
- $e = 9/8 \dots\dots\dots$  For roller bearings

When the load conditions vary at regular intervals, the life can be given by formula (3.6).

$$L_m = \left(\frac{\Phi_1}{L_1} + \frac{\Phi_2}{L_2} + \dots + \frac{\Phi_j}{L_j}\right)^{-1} \dots\dots\dots (3.6)$$

where,

- $L_m$  : Total life of bearing
- $\Phi_j$  : Frequency of individual load conditions ( $\sum \Phi_j = 1$ )
- $L_j$  : Life under individual conditions

**Adjusted rating life**

The basic bearing rating life (90% reliability factor) can be calculated by the formula (3.2) mentioned. However, in some applications a bearing life factor of over 90% reliability may be required. To meet these requirements, bearing life can be lengthened by the use of specially improved bearing materials or manufacturing process. Bearing life is also sometimes affected by operating conditions such as lubrication, temperature and rotational speed.

Basic rating life adjusted to compensate for this is called "adjusted rating life," and is determined by using the formula (3.7).

$$L_{na} = a_1 \cdot a_2 \cdot a_3 \cdot L_{10} \dots \dots \dots (3.7)$$

where,

- $L_{na}$  : Adjusted rating life in millions of revolutions ( $10^6$ )
- $a_1$  : Reliability factor
- $a_2$  : Bearing characteristics factor
- $a_3$  : Operating conditions factor

**Life adjustment factor for reliability  $a_1$**

The value of reliability factor  $a_1$  is provided in Table 3.1 for reliability of 90% or greater.

**Table 3.1 Reliability factor  $a_1$**

Reliability %	$L_n$	Reliability factor $a_1$
90	$L_{10}$	1.00
95	$L_5$	0.62
96	$L_4$	0.53
97	$L_3$	0.44
98	$L_2$	0.33
99	$L_1$	0.21

**Life adjustment factor for material  $a_2$**

Bearing characteristics concerning life vary according to bearing material, quality of material and use of special manufacturing processes. In this case, life is adjusted by the bearing characteristics factor  $a_2$ .

The basic dynamic load ratings listed in the catalog are based on NTN's standard material and process, therefore, the adjustment factor  $a_2 = 1$ .  $a_2 > 1$  may be used for specially enhanced materials and manufacturing methods. If this applies, consult NTN Engineering.

**Life adjustment factor for operating conditions  $a_3$**

Operating conditions factor  $a_3$  is used to compensate for when the lubrication condition worsens due to rise in temperature or rotational speed, lubricant deteriorates, or becomes contaminated with foreign matters.

Generally speaking, when lubricating conditions are satisfactory, the  $a_3$  factor has a value of one. And when lubricating conditions are exceptionally favorable and all other operating conditions are normal,  $a_3$  can have a value greater than one.  $a_3$  is however less than 1 in the following cases:

- Dynamic viscosity of lubricating oil is too low for bearing operating temperature (13 mm<sup>2</sup>/s or less for ball bearings, 20 mm<sup>2</sup>/s for roller bearings)
- Rotational speed is particularly low (If multiplication of rotational speed  $n$  min<sup>-1</sup> and pitch circle diameter across rolling elements  $d_m$  mm is  $d_m n < 10,000$ )
- Bearing operating temperature is too high
- Lubricant is contaminated with foreign matter or moisture

**■ New bearing life formula**

By dramatic improvement in bearing materials and bearing manufacturing techniques, bearings can offer a life several times as long as that calculated from the formula (3.7) as long as they are mounted with minimal mounting errors are fully free from foreign matter and adequately lubricated. This finding was obtained by a series of experiments performed by NTN. NTN's new bearing life calculation theory is based on a fatigue limit theory according to which under clean and efficient lubrication conditions, bearing life can be indefinite at a particular contact surface pressure. For this purpose, NTN performs calculations based on the contact surface pressure at a fatigue limit of 1.5 GPa that is defined in ISO281: 1990/Amd2: 2000. Incidentally, if foreign matter enters into a bearing, depending on the size and amount of foreign matter, the actual life of that bearing can be much shorter than the rating life that is calculated by formula (3.7). Also, poor lubricating conditions can cause the actual bearing life to be shorter than the rating life. NTN's new bearing life calculation is designed to determine a new life correction factor  $a_{NTN}$  by the following formula.

$$L_{min} = a_1 \cdot a_{NTN} \cdot \left(\frac{C}{P}\right)^p \quad (3.8)$$

**■ Bearing life theory**

**(1) Conventional Lundberg-Palmgren (L-P) theory**

According to this theory, a stress that governs rolling fatigue is considered, that is, a maximum dynamic shear stress  $\tau_o$  that is exerted, at a depth of  $Z_o$  from the rolling contact surface, in a plane parallel with the rolling contact surface. Referring to a theory of Neuber, et. al. which claims that the durability of a material deteriorates as the volume being subjected to a stress application decreases, the L-P theory assumes that a fissure occurring at a weak point of material at around the depth  $Z_o$  reaches the surface and leads to develop flaking. The probability of survival  $S$  of a volume  $V$  that is subjected to  $N$  times of stress application is determined by the formula below according to the Weibull theory.

$$\ln \frac{1}{S} \propto \frac{N^e \tau_o^e V}{z_h^c} \quad (3.9)$$

where,

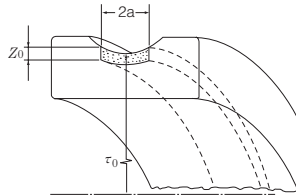
- $S$  : Probability of survival of stress volume  $V$
- $N$  : Number of repeated stress applications
- $e$  : Weibull slope (index to represent variation in life)
- $\tau_o$  : Maximum shear stress
- $Z_o$  : Depth from surface at which maximum shear stress occurs
- $c, h$  : Indexes

From the basic formula for the bearing life relative to rolling fatigue (3.9), a generic life formula below is obtained:

$$L_{10} = \left(\frac{C}{P}\right)^p \quad (3.10)$$

where,

- $L_{10}$  : Basic rating life
- $C$  : Basic dynamic load rating
- $P$  : Dynamic equivalent load
- $p$  :  $(e-h+2) / 3e$  (point contact)
- $(e-h+1) / 2e$  (line contact)



**Fig. 3.1 Stress volume resulting from rolling contact according to L-P theory**

**(2) NTN's new bearing life theory**

While the L-P theory intends to define internally occurring flaking owing to the shear stress within a material that results from hertzian contact, NTN's new bearing life theory is designed not only to evaluate surface-initiated flaking but also to determine life of each small segment ( $\Delta L_i$ ) based on a local stress ( $\sigma_i$ ). This is done by dividing an area from the interior to the contact surface of the material into small segments as illustrated in Fig. 3.2, and finally obtaining the overall bearing life  $L$  by the formula (3.13).

$$\ln \frac{1}{\Delta S_i} \propto \frac{\Delta N_i^e \sigma_i^e \Delta V_i}{z_h^c} \quad (3.11)$$

$$\Delta L_i = \Delta N_i \propto (\sigma_i^e \Delta V_i^c / z_h^c)^{1/e} \quad (3.12)$$

$$L = \left\{ \sum_{i=1}^n \Delta L_i^n \right\}^{1/n} \quad (3.13)$$

where,

- $\Delta S_i$  : probability of survival of stress volume  $\Delta V_i$  of divided segment
- $L$  : Overall bearing life
- $Z_i$  : Depth of divided small stress volume  $\Delta V_i$  from the surface
- $n$  : Number of segments
- $\sigma_u$  : Fatigue limit stress
- A stress below which a bearing does not develop failure (flaking) under ideal lubrication conditions.
- ISO 281: 1990/Amd2: 2000 specifies 1.5 GPa as a the maximum contact surface pressure at a fatigue limit. NTN uses it as a Von Mises stress equivalent to the maximum contact surface pressure 1.5 GPa.
- When  $\sigma_i$  is smaller than  $\sigma_u$  (fatigue limit), the life of a region in question ( $\Delta L_i$ ) will be infinitely long.

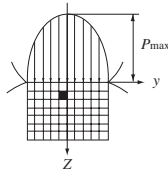


Fig. 3.2 Calculation model

**■ NTN's new bearing life formula**

The correlation between the NTN's life correction factor  $a_{NTN}$  and corrected rating life  $L_{nm}$  is defined by the formula (3.14) below.

$$L_{nm} = a_1 \cdot a_{NTN} \cdot \left(\frac{C}{P}\right)^p \dots \dots \dots (3.14)$$

where,

- $L_{nm}$  : Corrected rating life
- $a_1$  : Reliability coefficient
- $a_{NTN}$  : Life correction factor that reflects material properties, fatigue limit stress, contamination with foreign matter and oil film parameter ( $\Delta$ ) ( $0.1 \leq a_{NTN} \leq 50$ )
- $C$  : Basic dynamic load rating
- $P$  : Dynamic equivalent load
- $p$  : Index 3 (ball bearing) 10/3 (roller bearing)

**(1) Effect of fatigue limit**

NTN's new bearing life formula introduces a concept of fatigue life according to which the bearing life is infinitely long at a particular contact surface pressure as illustrated in Fig. 3.3 assuming no foreign matter is trapped in the bearing and the bearing is reliably lubricated.

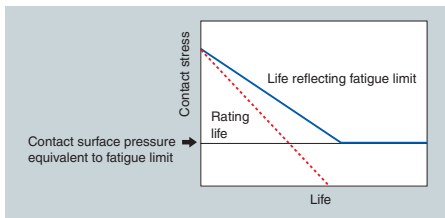


Fig. 3.3 Basic concept of fatigue limit

**(2) Effect of foreign matter**

The effect of foreign matter is treated as surface-initiated flaking that starts from a dent resulting from trapped foreign matter. NTN performs a bearing life calculation, assuming that the size of foreign matter and the stress concentration area in the middle portion (the size of this area corresponds with that of the foreign matter) in the surface layer as well as the amount of foreign matter significantly affect the bearing life.

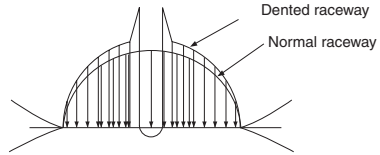


Fig. 3.4 Contact surface pressure distribution resulting from dent

**(3) Effect of oil film parameter ( $\Delta$ )**

The oil film parameter can be used to calculate bearing life. The oil film parameter, designated by  $\Delta$ , is the ratio of the oil film thickness to the roughness of the surface. It can be used to calculate the average stress across the surface layer of two contacting surfaces, such as a rolling element and raceway. From this surface layer stress, the contact surface pressure can be determined. Bearing life is then calculated from the contact surface pressure.

Conditions of two objects on surface layer  
Calculation model

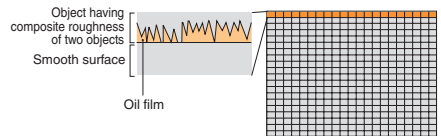


Fig. 3.5 Model of stress load onto the surface layer

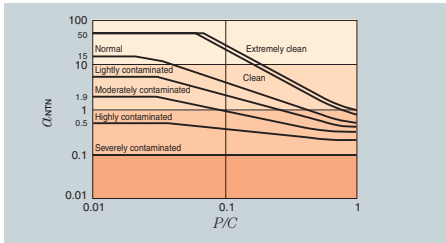
**■ New life calculation formula chart**

Various statuses of contamination with foreign matter are defined in Table 3.2. The values of ISO codes and NAS classes are those for ball bearings that are subjected to more severe operating conditions.

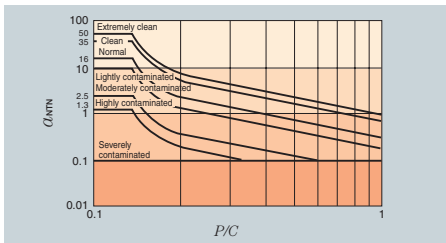
Table 3.2 Status of contamination

Condition of contamination	Extremely clean	Clean	Normal	Lightly contaminated	Moderately contaminated	Highly contaminated	Severely contaminated
Contamination coefficient	1	0.8	0.5	0.4	0.3	0.2	0.1
Guideline for application	Filtered						No filter
	Less than 10 m	10~30 μm	30~50 μm	50~70 μm	70~100 μm	100 m or more	Ingress of much dust
ISO cleanliness code (ISO 4406)	13/10	15/12	17/14	19/16	21/18	23/20	25/22
NAS class	0	3	6	8	9	10	12

**(1) Effect of foreign matter on correlation between load (P/C) and life correction factor  $a_{NTN}$**

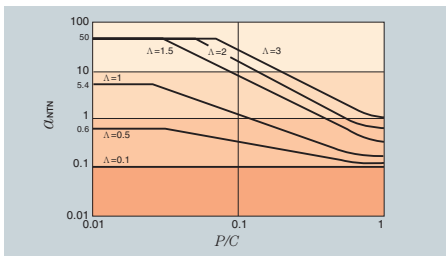


**Fig. 3.6 Correlation between P/C and  $a_{NTN}$  (effect of foreign matter in ball bearing)**

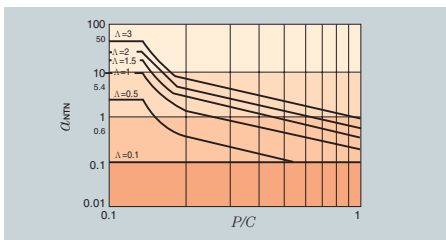


**Fig. 3.7 Correlation between P/C and  $a_{NTN}$  (effect of foreign matter in roller bearing)**

**(2) Effect of oil film parameter ( $\Delta$ ) on correlation between load (P/C) and life correction factor  $a_{NTN}$**



**Fig. 3.8 Correlation between P/C and  $a_{NTN}$  (effect of  $\Delta$  with ball bearing)**



**Fig. 3.9 Correlation between P/C and  $a_{NTN}$  (effect of  $\Delta$  with roller bearing)**

**② Static load rating and allowable axial load**

**Basic static load rating**

When stationary rolling bearings are subjected to static loads, they suffer from partial permanent deformation of the contact surfaces at the contact point between the rolling elements and the raceway. The amount of deformity increases as the load increases, and if this increase in load exceeds certain limits, the subsequent smooth operation of the bearings is impaired.

It has been found through experience that a permanent deformity of 0.0001 times the diameter of the rolling element, occurring at the most heavily stressed contact point between the raceway and the rolling elements, can be tolerated without any impairment in running efficiency.

The basic static load rating refers to a fixed static load limit at which a specified amount of permanent deformation occurs. It applies to pure radial loads for radial bearings and to pure axial loads for thrust bearings. The maximum applied load values for contact stress occurring at the rolling element and raceway contact points are given below.

For ball bearings	4 200MPa	{428kgf/mm <sup>2</sup> }
For self-aligning ball bearings	4 600MPa	{469kgf/mm <sup>2</sup> }
For roller bearings	4 000MPa	{408kgf/mm <sup>2</sup> }

Referred to as "basic static radial load rating" for radial bearings and "basic static axial load rating" for thrust bearings, basic static load rating is expressed as  $C_{or}$  or  $C_{oa}$  respectively and is provided in the bearing dimensions table.

**Allowable static equivalent load**

Generally the static equivalent load which can be permitted is limited by the basic static rating load as stated above. However, depending on requirements regarding friction and smooth operation, these limits may be greater or lesser than the basic static rating load.

This is generally determined by taking the safety factor  $S_o$  given in **Table 3.3** and formula (3.13) into account.

$$S_o = C_o / P_o \dots \dots \dots (3.13)$$

where,

- $S_o$  : Safety factor
- $C_o$  : Basic static load rating, N {kgf}
  - radial bearings:  $C_{or}$ ,
  - thrust bearings:  $C_{oa}$
- $P_o$  : Static equivalent load, N {kgf}
  - radial bearings:  $P_{or}$ ,
  - thrust bearings:  $P_{oa}$



**Table 3.3 Minimum safety factor values  $S_0$**

Operating conditions	Ball bearings	Roller bearings
High rotational accuracy necessary	2	3
Normal rotating accuracy necessary (Universal application)	1	1.5
Slight rotational accuracy deterioration permitted (Low speed, heavy loading, etc.)	0.5	1

Note: When vibration and/or shock loads are present, a load factor based on the shock load needs to be included in the  $F_0$  max value.

**■ Allowable axial load**

A greater axial load can be exerted on a main spindle bearing on a machine tool allowing for tool changes while the machine is stationary. When an angular contact ball bearing is subjected to a larger axial load, the contact ellipse between its rolling elements and raceway surface can overflow the raceway surface (Fig. 3.10). Furthermore, even if the contact ellipse remains within the raceway surface, overstressing can cause problems such as denting.

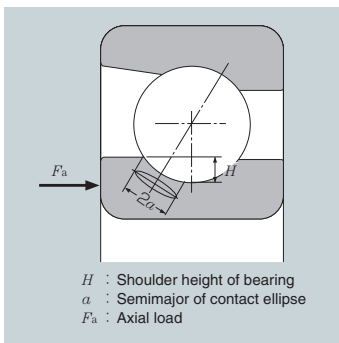
The maximum allowable load that does not cause such problems is defined as the "allowable axial load."

The allowable axial load is reached when either of the following conditions occurs.

- The end of contact ellipse on the raceway surface reaches the shoulder of either an inner or outer ring.
- The contact surface pressure on the raceway surface reaches 3650 MPa in either the inner or outer ring raceway.

Note that the contact surface pressure of 3650 MPa on the raceway surface is a value that leads to a permanent deformation of 0.00002 to 0.00005 times as much as the rolling element diameter and has been determined through many years of experience.

The allowable axial load for each bearing is found in the associated dimensions table.



**Fig. 3.10**

## 4. Allowable Speed

High bearing speed leads to high temperature rise on the bearing owing to frictional heating within the bearing. When the temperature of the bearing exceeds a particular limit, the lubricant performance deteriorates significantly, possibly leading to bearing overheating or seizure.

The factors that can affect the maximum allowable bearing speed include:

- (1) Bearing type
- (2) Bearing size
- (3) Lubrication system (grease lubrication, air-oil lubrication, jet lubrication, etc.)
- (4) Internal clearance or preload on the bearing
- (5) Bearing arrangement (2-row, 3-row, 4-row)
- (6) Bearing load
- (7) Accuracies of shaft, housing, etc.

The maximum allowable speeds listed in the bearing dimensions tables are reference values and are applicable only to individual bearings that are adequately lubricated and correctly preloaded under a condition where the heat is reliably removed from the bearing arrangement.

In the case of grease lubrication, these speeds are attainable only when the bearing is filled with an adequate amount of high-quality grease as given in Table 7.3, the bearing is sufficiently run in, and heat is removed by an arrangement such as a cooling jacket. In the case of oil lubrication, these speeds are attained only by an air-oil lubrication system if an adequate amount of VG10 or 32 spindle oil is supplied and the heat is removed by an arrangement such as a cooling jacket. When using a large amount of lubricant, a jet lubrication system excels in lubrication and cooling performance, and can permit operation at the maximum allowable speed. However, this lubrication system involves a high power loss and should be employed carefully.

**■ Speed factor**

The maximum allowable speed of a particular bearing can vary depending on the relation between heat generation and heat dissipation in the bearing as well as how well the bearing is lubricated. The bearing arrangements (2-row to 4-row) and speed reduction ratios (speed factors) for maximum allowable speed due to post-assembly preloads are summarized in Table 4.1.

**Table 4.1 Speed factor by bearing arrangement and preload**

Bearing arrangement	Matching	GL	GN	GM
	DB	0.85	0.8	0.65
	DBT	0.7	0.6	0.5
	DTBT	0.8	0.75	0.6

## 5. Bearing Arrangements and Structures of Bearings for Main Spindles

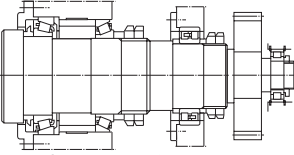
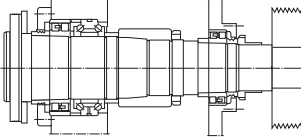
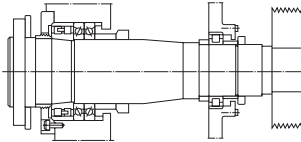
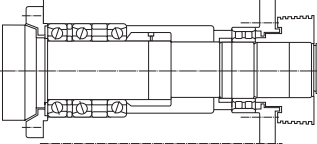
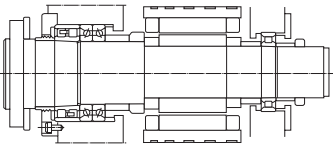
### ① Bearing Arrangement for Main Spindles

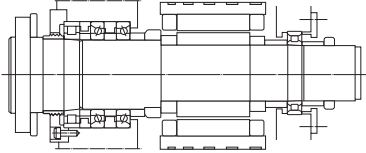
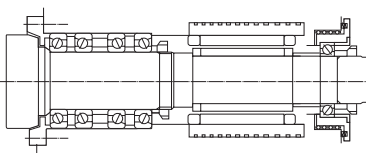
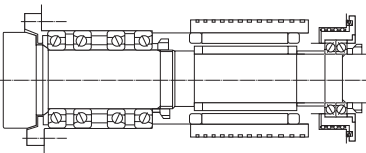
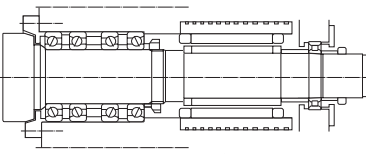
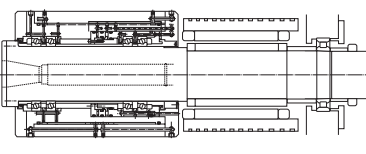
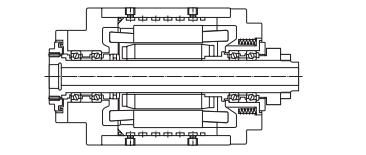
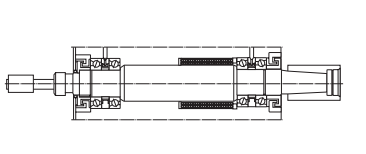
Typical examples of bearing arrangements for main spindles of machine tools are summarized in **Table 5.1**.

An optimal bearing arrangement must be determined through considerations about the properties required of the main spindle in question (maximum speed, radial and axial rigidities, main spindle size, required

accuracies, lubrication system, etc.). Recently, an increasing number of new machine tool models incorporate built-in motor type main spindles. However, heat generation on a built-in motor can affect the accuracy of the main spindle and performance of lubrication, so a main spindle bearing should be selected very carefully.

**Table 5.1** Typical examples of bearing arrangements for main spindles

Bearing arrangement for main spindle	Bearing type	Typical applications
 <p style="text-align: center;">Gear-driven configuration</p>	[Type I] Tapered roller bearing + Tapered roller bearing + Double-row cylindrical roller bearing	Large turning machine Oil country lathe General-purpose turning machine  Typical lubrication ● Grease lubrication
 <p style="text-align: center;">Belt-driven configuration</p>	[Type II] Double-row cylindrical roller bearing + Double-direction angular contact thrust ball bearing + Double-row cylindrical roller bearing	CNC turning machine Machining center Boring machine Milling machine  Typical lubrication ● Grease lubrication
 <p style="text-align: center;">Belt-driven configuration</p>	[Type III] Double-row cylindrical roller bearing + High-speed duplex angular contact ball bearing for axial load + Single-row cylindrical roller bearing  NOTE: high-speed variant of type II	CNC turning machine Machining center Milling machine  Typical lubrication ● Grease lubrication
 <p style="text-align: center;">Belt-driven configuration</p>	[Type IV] Duplex angular contact ball bearing (DBT arrangement) + Double-row cylindrical roller bearing  NOTE: high-speed variant of type II or III	CNC turning machine Machining center Milling machine  Typical lubrication ● Grease lubrication
 <p style="text-align: center;">Built-in motor-driven configuration</p>	[Type V] Double-row cylindrical roller bearing + High-speed duplex angular contact ball bearing for axial load + Single-row cylindrical roller bearing  NOTE: high-speed variant of type III with built-in motor-driven configuration	CNC turning machine Machining center Milling machine  Typical lubrication ● Grease lubrication ● Air-oil lubrication

Bearing arrangement for main spindle	Bearing type	Typical applications
 <p>Built-in motor-driven configuration</p>	<p>[Type VI] Single-row cylindrical roller bearing + High-speed duplex angular contact ball bearing for axial load + Single-row cylindrical roller bearing</p> <p>NOTE: high-speed variant of type V</p>	<p>CNC turning machine Machining center</p> <p>Typical lubrication ● Grease lubrication ● Air-oil lubrication</p>
 <p>Built-in motor-driven configuration</p>	<p>[Type VII] Duplex angular contact ball bearing (DTBT arrangement) + Single-row angular contact roller bearing (w/ ball slide)</p> <p>NOTE: super high-speed variant</p>	<p>Machining center &lt;vertical&gt;</p> <p>Typical lubrication ● Grease lubrication ● Air-oil lubrication</p>
 <p>Built-in motor-driven configuration</p>	<p>[Type VIII] Duplex angular contact ball bearing (DTBT arrangement) + Duplex angular contact roller bearing (w/ ball slide)</p> <p>NOTE: super high-speed variant</p>	<p>Machining center &lt;vertical&gt;</p> <p>Typical lubrication ● Grease lubrication ● Air-oil lubrication</p>
 <p>Built-in motor-driven configuration</p>	<p>[Type IX] Duplex angular contact ball bearing (DTBT arrangement) + Single-row cylindrical roller bearing</p> <p>NOTE: super high-speed variant</p>	<p>Machining center</p> <p>Typical lubrication ● Grease lubrication ● Air-oil lubrication</p>
 <p>Built-in motor-driven configuration</p>	<p>[Type X] Adjustable preload bearing unit + Duplex angular contact ball bearing (DBT arrangement) + Single-row cylindrical roller bearing</p> <p>NOTE: high-rigidity/super high-speed variant</p>	<p>Machining center</p> <p>Typical lubrication ● Air-oil lubrication</p>
 <p>Built-in motor-driven configuration</p>	<p>[Type XI] Duplex angular contact ball bearing (DT arrangement) + Duplex angular contact ball bearing (DT arrangement)</p>	<p>Machining center Small turning machine Grinding machine</p> <p>Typical lubrication ● Grease lubrication ● Air-oil lubrication</p>
 <p>Belt-driven configuration</p>	<p>[Type XII] Duplex angular contact ball bearing (DT arrangement) + Duplex angular contact ball bearing (DT arrangement)</p>	<p>Grinding machine</p> <p>Typical lubrication ● Grease lubrication ● Air-oil lubrication ● Oil-mist lubrication</p>




## ② Bearing selection based on bearing arrangement for main spindle

An optimal bearing product that best suits the application is selected by referring to the bearing selection table in **Table 5.2**, which contains the possible bearing arrangements for main spindles.

- Designate the free side and fixed side.
- Select the bearing arrangement type (I to XII) on the free or fixed side.

- Select a set of bearing specifications applicable to the selected arrangement type.
- Choose a lubrication system suitable for the selected bearing specifications.
- Select a product group that satisfies the above-mentioned considerations.

**Table 5 2 Bearing selection table**

Fix side	Free side	Bearing specifications	Lubrication system	Applicable product groups/ULTAGE		Considerations for selection procedure	
				Steel balls/ceramic balls			
Duplex angular contact ball bearing or adjustable preload bearing mechanism + Duplex angular contact ball bearing  Bearing arrangement [Type IV, VI, VIII, IX, XI, or XII]	Single-row angular contact ball bearing or duplex angular contact ball bearing (w/ ball bush)  Bearing arrangement [Type VII, VIII, XI, or XII]	Angular contact ball bearing for radial load  Contact angle 30° or smaller	Grease lubrication	Sealed	[15°, 25°] 79 LLB/5S-79 LLB 70 LLB/5S-70 LLB  [15°, 20°, 25°] 2LA-BNS9 LLB/5S-2LA-BNS9 LLB 2LA-BNS0 LLB/5S-2LA-BNS0 LLB	Bearing selection ① High-speed performance (general) High ⇔ Low Contact angle 15°, 20°, 25°, 30°  ② Rigidity · Radial rigidity High ⇔ Low Contact angle 15°, 20°, 25°, 30° · Axial rigidity Low ⇔ High Contact angle 15°, 20°, 25°, 30°, 40°, 60°  · Complex rigidity (radial and axial)  High (4-row)   Medium (3-row)   Low (2-row) 	
					[15°] 78C, 72C [15°, 25°, 30°] 79U/5S-79U, 70U/5S-70U [15°, 20°, 25°] 2LA-HSE9U/5S-2LA-HSE9U 2LA-HSE0/5S-2LA-HSE0		
					Grinding machine main spindle/motor shaft series [15°] BNT9/5S-BNT9 BNT0/5S-BNT0 BNT2/5S-BNT2		
					Super high-speed/dedicated air-oil lubrication series [25°] 5S-2LA-HSF0  Eco-friendly type [20°, 25°] 5S-2LA-HSL9U 5S-2LA-HSL0 5S-2LA-HSFL0  With re-lubricating hole on the outer ring [20°, 25°] 5S-2LA-HSEW9U 5S-2LA-HSEW0		
Cylindrical roller bearing + Duplex angular contact ball bearing  Bearing arrangement [Type II, III, V or VI]	Double-row cylindrical roller bearing or single-row cylindrical roller bearing  Bearing arrangement [Type I, II, III, IV, V, VI, IX, or X]	Cylindrical roller bearing  Angular contact ball bearing for axial load  Contact angle less than 60°  Thrust contract ball bearing	Grease lubrication	Double-row NN30/NN30K NN30HS/NN30HSK NN30HST6/NN30HST6K NN30HSRT6/NN30HSRT6K NN49/NN49K NNU49/NNU49K  Single-row N10HS/N10HSK N10HSRT6/N10HSRT6K  Eco-friendly type N10HSLT6/N10HSLT6K	③ Recommended arrangement 4-row (DTBT) or 2-row (DB)  ④ Recommended lubrication specifications Standard main spindle : Grease High-speed main spindle : Air-oil Low-noise : Grease or eco-friendly air-oil		
						Grease lubrication	[30°] HTA9A HTA0A/5S-HTA0A  [40°] HTA9U HTA0U/5S-HTA0
							[60°] 5629/5629M 5620/5620M
						Oil lubrication	329XU 4T-320X/320XU Inch series tapered roller bearing
Tapered roller bearing + Cylindrical roller bearing Bearing arrangement [Type I]		Cylindrical roller bearing	Grease lubrication		⑤ Presence of cooling jacket around the bearing. In particular, grease lubrication is recommended.		

### ③ Adjustable preload bearing unit

A recent trend in the machine tool industry is a steady increase of operating speeds. The maximum  $d_{min}$  value (pitch circle diameter across rolling elements  $d_m$  [mm] multiplied by speed  $n$  [min<sup>-1</sup>]) reached by main spindles with air-oil lubricated lubrication can be as high as  $2.5$  to  $3.8 \times 10^6$ . At the same time, main spindles are requiring increased rigidity. Therefore, main spindle bearings must be capable of both high-speed operation and high rigidity. This can be achieved through optimal preloading.

A fixed preload (spring preload) system is usually employed to satisfy both these high speed and high rigidity requirements. A spindle unit with fixed-position preload that is adjustable for different speed conditions is advantageous for optimizing the rigidity of the unit.

The NTN Adjustable Preload Bearing Unit is a high-speed, high-rigidity unit that features fixed position

preload that can be adjusted for different speed conditions.

The NTN Adjustable Preload Bearing Unit is illustrated in Fig. 5.1. Hydraulic pressure is used to shift the position of the adjustable preload sleeve situated in the rear bearing section of the unit. This changes the preload on the bearings.

A spindle incorporating a 3-step adjustable preload bearing unit is illustrated in Fig. 5.2. The sleeve in the adjustable preload section is comprised of two hydraulic pressure chambers, A and B, as well as a spiral groove for sliding motion. The preload can be adjusted to one of three settings by changing the hydraulic pressure in each of the chambers. To achieve instantaneous and reliable adjustment, high-pressure oil (at the same pressure as in the hydraulic chambers) is supplied to the spiral groove on the outside of the sleeve. This oil provides lubrication so that the sleeve can move smoothly.

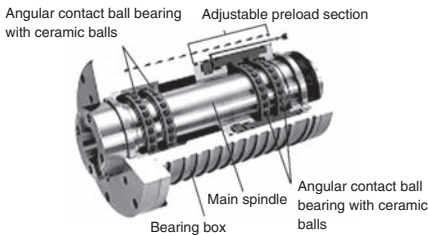


Fig. 5.1 Adjustable preload bearing unit

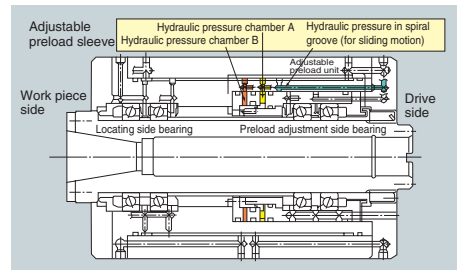


Fig. 5.2 Typical spindle configuration incorporating 3-step Adjustable Preload Type Bearing Unit

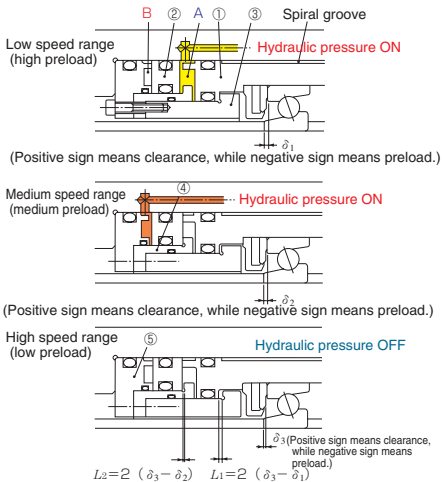


Fig. 5.3 Operating mechanism of Adjustable preload

#### ■ Operating mechanism

Fig. 5.3 shows the hydraulic operation of the unit for three preloading conditions as well as the associated motion of the adjustable preload sleeve.

- **Low speed operation (high preload): Chamber A is pressurized.** Component ① moves to the right by a preset clearance  $L_1$  and contacts component ③. The axial clearance is  $\delta_1$ .
- **Medium speed operation (medium preload): Chamber B is pressurized.** Components ① and ② move to the right by a preset clearance  $L_2$ , causing Component ② to contact Component ④. The axial clearance is  $\delta_2$ .
- **High speed operation (low preload): Chambers A and B are not pressurized.** Components ① and ② return to the left due to the reaction force on the bearing. This causes Component ② to contact Component ⑤, thereby returning the axial clearance to the initial setting of  $\delta_3$ .

NOTE: The return motion of the components ① and ② is achieved by the reaction force of bearing or a separately provided spring.

#### ④ Bearing jacket cooling system

With a built-in motor drive system, the main spindle is directly driven by a motor and is therefore suitable for rapid acceleration or deceleration. However, this system can be adversely affected by temperature rise. A cooling jacket with a spiral groove around the housing allows cooling oil to flow through the unit.

If heat generated by the motor affects the bearing, overheating of the bearing as well as degradation of the grease can occur. This situation must be strictly avoided. When designing a cooling system with jacket cooling, the following should be considered.

#### ■ Considerations about cooling of jacket

A typical bearing arrangement is shown in Fig. 5.4 and 5.5, comprising a double-row cylindrical roller bearing and an angular contact ball bearing set. The cooling groove on the jacket in Fig. 5.4 starts at around an area above the angular contact ball bearings and does not cool the double-row cylindrical roller bearing effectively.

(Note that the fit of the angular contact ball bearings with the bore of the housing is a clearance fit—the bearings are not in direct contact with the housing) In the configuration in Fig. 5.5, the cooling groove extends to the region above the double-row cylindrical roller bearing, and cools both the angular contact ball bearings and the double-row cylindrical roller bearing effectively.

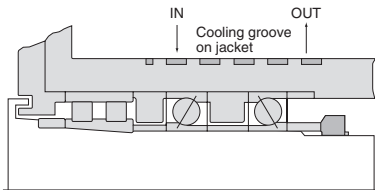


Fig. 5.4 Inadequate cooling groove on jacket

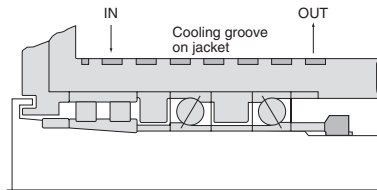


Fig. 5.5 Adequate cooling groove on jacket

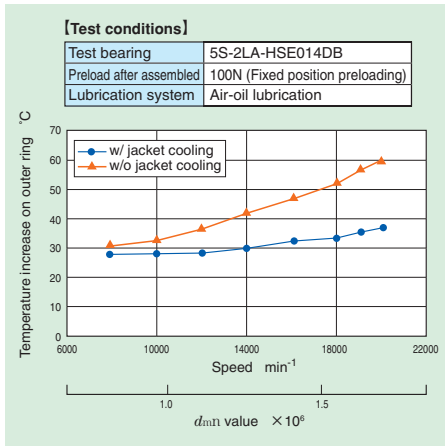


Fig. 5.6 Variation in bearing temperature depending on presence/absence of jacket cooling (angular ball bearing)

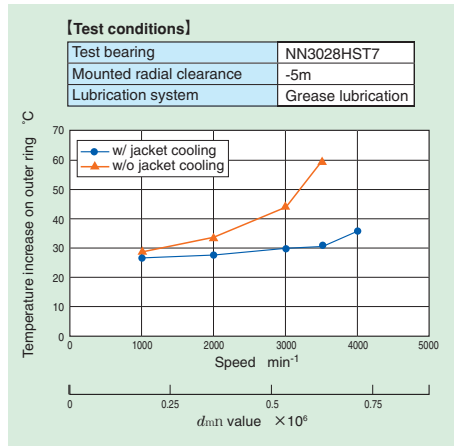


Fig. 5.7 Variation in bearing temperature depending on presence/absence of jacket cooling (cylindrical roller bearing)

## 6. Handling of Bearings

### ① Cleaning and filling with grease

To achieve maximum speed and limited temperature rise with a precision rolling bearing, it is vital to handle the bearing correctly.

The handling of bearings involves cleaning, drying, filling with grease (if necessary), and the running-in operation. For each step, follow the precautions and instructions.

A sealed bearing contains prefilled grease. Do not clean (rinse) and dry this type of bearing. Only wipe away rust-preventive oil with a clean cloth before assembling the bearing.

#### ■Cleaning (removal of rust-preventive oil)

- Immerse the bearing in kerosene or a highly volatile solvent such as naphthosol and wash it by hand. Then remove the kerosene using benzene or alcohol. Use clean compressed air to blow away the rinsing fluid.

(The bearing may be used as delivered for the air-oil lubrication. However, we recommend that after cleaning, the bearing either be coated with the lubricant to be used or a less viscous oil, or be immersed in the lubricant or other low-viscosity oil.)

#### ■Drying

If the bearing is to be used with grease lubrication, it is necessary to thoroughly dry the bearing to avoid leakage

of grease. After drying, be sure to immediately fill the bearing with grease.

Drying can be performed by blowing hot air onto the bearing or placing the bearing in a chamber at constant temperature. When drying by hot air, be sure to consider the cleanliness of the air.

#### ■Filling with grease

The procedures for greasing ball and roller bearings can be found below.

After filling with grease, turn the bearing by hand to uniformly distribute the grease to the whole rolling surface.

#### <Ball bearings> See Photo 6.1

- By using an injector or small plastic bag, fill grease between balls in equal amounts, aiming at the inner ring rolling surface.
- For a bearing with a ring-guided cage, also apply grease to the guide surface of the cage using a spatula or similar tool.
- If grease cannot be filled into the inner ring rolling surface because of a small gap between the cage and the inner ring add grease to the outer ring rolling surface. In this case, carefully turn the bearing so that the grease is fully spread on the inner ring side.

#### <Roller bearings> See Photo 6.2

- Apply grease to the outer (inner) side of rollers, and while turning the rollers with fingers, spread the grease to the inner ring (outer ring) side.



By using an injector or small plastic bag, fill grease between balls in equal amounts, aiming at the rolling surface of the inner ring.



After completion of filling



Turn the bearing by hand while applying an appropriate load in the contact angle direction so that the any area in the interior of bearing is sufficiently lubricated with grease.



Apply grease to the outer circumference of cage.



Apply grease to the outer side of the rollers, and while turning the rollers with fingers, spread the grease to the inner ring (outer ring) side.



(After applying grease)  
If a lump of grease remains on the outer face of cage rib, the running-in operation can take a longer time. With fingers, spread the grease deposited on the outer surface of the rib on the cage.

Photo. 6.1 Filling grease into angular contact ball bearing

Photo. 6.2 Filling grease into cylindrical roller bearing

**Running-in operation**

**(1) Air-oil or oil-mist lubrication**

The running-in operation is relatively simple with oil lubrication because no peak temperature occurs and the bearing temperature stabilizes within a relatively short time. NTN recommends that the speed of bearing is to be increased in steps of 2000 to 3000 min<sup>-1</sup> until the maximum speed is reached.

Every speed setting should be maintained for about 30 minutes. However, for the speed range where the  $d_{m1}$  (pitch circle diameter across rolling elements multiplied by speed) exceeds  $1.0 \times 10^6$ , increase the bearing speed in steps of 1000 to 2000 min<sup>-1</sup> to ensure the stable running.

**(2) Grease lubrication**

For a grease-lubricated bearing, a running-in operation is very important in attaining stable temperature rise. During a running-in operation, a large temperature rise (peak) occurs while the bearing speed is increased, and then the bearing temperature eventually stabilizes.

Before temperature stabilization, a certain lead time will be needed.

**Ball bearing**

NTN recommends that the bearing speed be increased in steps of 1000 to 2000 min<sup>-1</sup> and be further increased only after the temperature has stabilized at the current speed setting.

However, for the speed range where the  $d_{m1}$  exceeds  $0.4 \times 10^6$ , increase the bearing speed in steps of 500 to 1000 min<sup>-1</sup> to ensure the stable running.

**Roller bearing**

Compared with contact ball bearings, the time to peak temperature or saturation in running-in operation of roller bearings tends to be longer. Also, there will be temperature rise due to whipping of the grease and the

temperature rise may be unstable. To cope with this problem, run the roller bearing in the maximum speed range for a prolonged period.

Increase the bearing speed in steps of 500 to 1000 min<sup>-1</sup> only after the bearing temperature has stabilized at the current speed setting.

For the speed range where the  $d_{m1}$  exceeds  $0.3 \times 10^6$ , increase the bearing speed in steps of 500 min<sup>-1</sup> to ensure safety.

**Mounting**

When mounting a bearing to a main spindle, follow either of the mounting techniques described below

**(1) Press-fitting with hydraulic press**

**(2) Mounting by heating bearings**

With either technique, it is important to minimize the adverse effects of the mounting process to maintain bearing accuracy.

**(1) Press-fitting with hydraulic press**

Before press-fitting a bearing with a hydraulic press or hand press, the press-fitting force due to the interference between the shaft and inner ring must be calculated. A hydraulic press having a capacity greater than the required press-fitting force must be used. Next, using an inner ring press-fitting jig, the inner ring is correctly press-fitted to the shoulder of shaft. Please be careful not to exert a force on the outer ring.

After the press-fitting operation, it is important to measure the accuracies of various portions of the bearing to verify that the bearing has been correctly mounted to the shaft. When using a multi row bearings, measure the runout after assembly and correct misalignment across the outer rings as necessary.

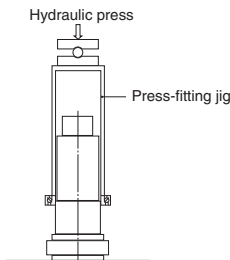


Fig. 6.1 Press-fitting pressure

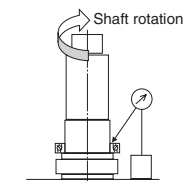


Fig. 6.2 Checking for face runout of inner ring

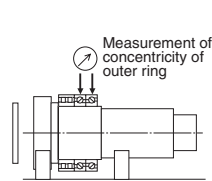


Fig. 6.3 Checking for concentricity of outer ring

**Calculation of press-fitting force**

The press-fitting force occurring from the interference between the shaft and inner ring can be determined by the formula given below.

According to the calculated press-fitting force, a hydraulic press having a sufficiently large capacity must be used to mount the bearing. The variations in dimensional errors among the bearings should be considered. The force needed to press the inner ring to the shaft can be obtained with the following formula (6.1).

Force to press-fit inner ring to shaft  

$$K_d = \mu \cdot P \cdot \pi \cdot d \cdot B \dots \dots \dots (6.1)$$

where,

$K_d$ : Force for press-fitting or extracting an inner ring N

$P$ : Surface pressure on fitting surface MPa (see Table 6.1)

$d$ : Shaft diameter, inner ring bore diameter mm

$D$ : Outer ring outside diameter mm

$B$ : Inner ring width

$\mu$ : Sliding friction coefficient (when press-fitting inner ring over cylindrical shaft: 0.12)



Table 6.1

Fitting conditions and calculation formulas		Symbol (unit N [kgf]·mm)
Fitting surface pressure MPa (kgf/mm <sup>2</sup> )	Fits between solid steel shaft and inner ring $P = \frac{E}{2} \frac{\Delta d_{eff}}{d} \left[ 1 - \left( \frac{d}{D_i} \right)^2 \right] \dots \dots \dots (6.2)$	$d$ : Shaft diameter, inner ring bore diameter $d_0$ : Hollow shaft bore diameter $D_i$ : Inner ring average raceway groove diameter
	Fits between hollow steel shaft and inner ring $P = \frac{E}{2} \frac{\Delta d_{eff}}{d} \frac{[1 - (d_0/D_i)^2] [1 - (d_0/d)^2]}{[1 - (d_0/D_i)^2]} \dots \dots \dots (6.3)$	$\Delta d_{eff}$ : Effective interference $E$ : Modulus of longitudinal elasticity = 210 GPa

$$\Delta d_{eff} = \frac{d}{d+2} \Delta d \dots \dots \dots (6.4)$$

(In the case of a ground shaft)

$\Delta d$ : Theoretical interference fitting

$$D_i = 1.05 \frac{4d+D}{5} \dots \dots \dots (6.5)$$

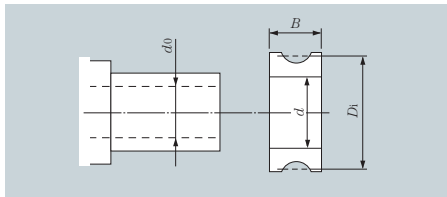


Fig. 6.4

**Example of calculation for press-fitting force**

The calculation for press-fitting force for tight fit of 2  $\mu$ m interference between the shaft and inner ring for the standard angular contact ball bearing is as summarized below:

- 7020UC ( $\phi 100 \times \phi 150 \times 24$ )
- Interference fit of 2  $\mu$ m (solid shaft)

$$\Delta d_{eff} = \frac{100}{102} \times 0.002 = 0.00196$$

$$D_i = 1.05 \times \frac{4 \times 100 + 150}{5} = 115.5$$

$$P = \frac{210000}{2} \times \frac{0.00196}{100} \left[ 1 - \left( \frac{100}{115.5} \right)^2 \right] = 0.52 \text{ MPa}$$

$$= 0.12 \times 0.52 \times \pi \times 100 \times 24 = 470 \text{ N}$$

To accommodate for variation in the lubrication conditions, incorporate a safety factor of 2 to 3. As a result, the required press-fitting force is:

$$470 \times (2 \text{ to } 3) = 940 \text{ to } 1410 \text{ N}$$

**(2) Mounting by heating bearings**

When mounting a bearing to a shaft using a constant temperature chamber, bearing heater or the like, follow the instructions below.

Heat the bearing at a temperature that reflects the interference between the shaft and inner ring (see Fig. 6.5).

Assuming linear expansion coefficient  $12.5 \times 10^{-6}$ , heating temperature  $\Delta$ , inner ring bore diameter  $\phi d$ , and interference fit

$$\delta = 12.5 \times 10^{-6} \times d \times \Delta$$

Ex.) If  $\phi d = 100$  mm, and  $\delta = 0.030$  (30  $\mu$ m, tight fit), then the required heating temperature  $\Delta = 23.8^\circ\text{C}$ .

Therefore, the bearing should be heated to approximately room temperature + 30°C. Note that in practice, the lower-temperature shaft will cool the bearing, causing it to shrink. Consequently the bearing may need to be heated by more than 30°C for assembly.

**NOTE**

- If a resin material is used for the cage of angular contact ball bearing, do not excessively heat the bearing (approx. 80°C max.).
- As a result of heating bearings after cooling, the inner ring will axially shrink, and there will be clearance between the bearing side face and shaft shoulder (Fig. 6.6). For this reason, keep the bearing and shaft forced together with a press or the like after the unit returns to normal temperature. After cooling, check that the bearing is mounted to the shaft correctly.
- When using a bearing heater, be sure to avoid overheating. To prevent bearing from being magnetized, use equipment that has a demagnetizing feature.

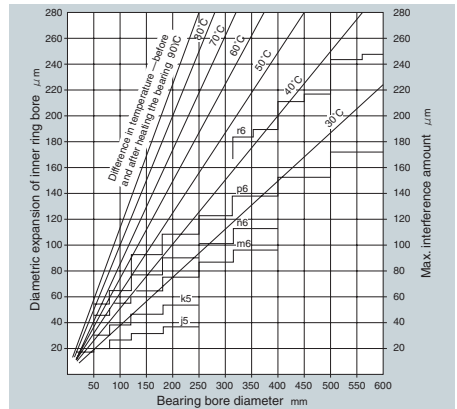


Fig. 6.5 Required heating temperature for mounting by heating inner ring

Remarks: The maximum interference amounts are interference values associated with class 0 bearings.

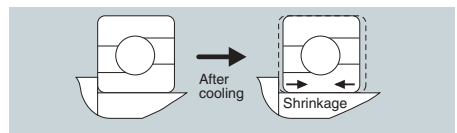


Fig. 6.6 Cooling after mounting by heating bearings

### ③ Tightening of inner ring

When mounting and securing a bearing to a main spindle, the inner ring side face is usually clamped with a stepped sleeve or precision bearing nut, and the front cover situated on the outer ring side face is bolted down. When utilizing a stepped sleeve or precision bearing nut to clamp the inner ring, the following precautions must be followed.

#### ■ Tightening with stepped sleeve

The stepped sleeve is designed that the hydraulically expanded sleeve is inserted over the shaft, and a predetermined drive-up force (tightening force) is applied to the shaft. Then the hydraulic pressure is released in order to secure the sleeve onto shaft and provide a tightening force to the bearing. This technique is a relatively simple locking method (Fig. 6.7).

Note however after being locked in position by interference with the shaft, the sleeve can come loose because of deflection of the shaft or a moment load applied to the shaft.

For this reason, in many cases, a stepped sleeve is used together with a bearing nut as illustrated in Fig. 6.8.

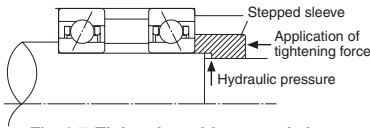


Fig. 6.7 Tightening with stepped sleeve

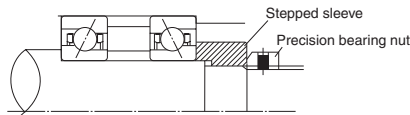


Fig. 6.8 Tightening with stepped sleeve + precision bearing nut

#### ■ Tightening with precision bearing nut

Required tightening force is achieved with the precision bearing nut (precision locknut) by correctly controlling the tightening torque.

Note that when a bearing has been locked with a precision bearing nut (lock nut), the nut can develop inclination owing to the clearance on the threaded portions. If this problem occurs, fine adjustment will be necessary to obtain necessary running accuracy for the shaft.

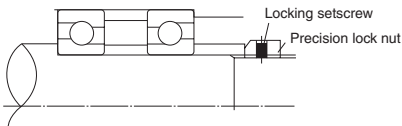


Fig. 6.9 Tightening with precision bearing nut

#### ■ Correlation between tightening torque and tightening force with precision bearing nut

The correlation between tightening torque and tightening force with a precision bearing nut can be defined with the formula given below.

Because the thread face of the precision bearing nut, the thread face of the shaft and the bearing surface and nut constitute sliding surfaces, the correlation between tightening torque and tightening force will vary depending on the friction coefficient. Therefore, the nut needs to be thoroughly run on the shaft thread in advance to ensure smooth and uniform tightening.

It is also necessary to determine the correlation between tightening torque and tightening force by using a load washer or the like in advance.

$$F = \frac{M}{(d/2) \tan(\beta + \rho) + r_n \mu_n} \quad (6.6)$$

- $F$  : Thread tightening force N
- $M$  : Nut tightening torque N-mm
- $d$  : Effective diameter of thread mm
- $\rho$  : Friction angle of thread face

$$\tan \rho = \frac{\mu}{\cos \alpha} \quad (6.7)$$

$$\beta : \text{Lead angle of thread}$$

$$\tan \beta = \text{number of threads} \times \text{pitch} / \pi d \quad (6.8)$$

- $r_n$  : Average radius of bearing nut surface mm
- $\mu_n$  : Friction coefficient of bearing nut surface
- $\mu_n \cong 0.15$
- $\mu$  : Friction coefficient of thread face  $\mu \cong 0.15$
- $\alpha$  : Half angle of thread

#### Example calculation

- Bearing nut AN20 (Fig. 6.10)
- Thread data M100×2 (class 2 thread)
- Effective diameter  $d = \phi 98.701$  mm
- Half angle of thread  $\alpha = 30^\circ$

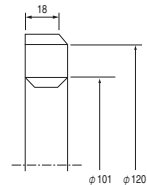


Fig. 6.10

The correlation between a tightening torque and tightening force with the precision bearing nut can be calculated as follows:

$$\tan \rho = \frac{0.15}{\cos 30^\circ} \quad \rho = 9.826^\circ$$

$$\tan \beta = \frac{1 \times 2}{\pi \times 98.701} \quad \beta = 0.370^\circ$$

$$r_n = \frac{(101 + 120)/2}{2} = 55.25$$

$$F = \frac{M}{\frac{98.701}{2} \tan(0.370 + 9.826) + 55.25 \times 0.15}$$

$$= \frac{M}{17.163}$$

#### ④ Elastic deformation of spacer by tightening force

When incorporating a bearing into a main spindle, the bearing must be correctly forced into a predetermined position and maintained with a predetermined bearing pressure in order to maintain appropriate accuracies, clearances and rigidities of the bearing and main spindle.

When axially locating a duplex angular contact ball bearing by using a bearing spacer the cross-sectional area of spacer as well as (depending on the tightening force) the bearing pressure and elastic deformation by tightening of the spacer must be considered.

##### ■ Correlation between inner ring spacer tightening force and amount of elastic deformation

When securing an angular contact ball bearing onto a main spindle, the bearing inner ring is tightened and locked by the shoulder of main spindle and a bearing nut and/or stepped sleeve. This inner ring tightening force causes the spacer to develop elastic deformation in the axial direction, varying the axial clearance on the bearing. In the case of a back-to-back duplex bearing (DB, DTBT or DBT) for a main spindle in particular, the inner ring tightening force will decrease the bearing clearance, possibly leading to an increased post-assembly preload and operating preload. A possible inner ring tightening force-derived axial deformation can develop in the form of deformation of both the inner ring and inner ring spacer. However, NTN's experience has shown that only the elastic deformation on inner ring spacers needs to be considered.

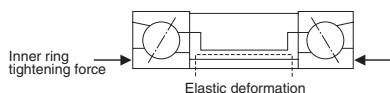


Fig. 6.11 Elastic deformation of inner ring spacer

The amount of deformation of a spacer is calculated using the following formula:

$$\delta = \frac{P \times L}{A \times E} \dots \dots \dots (6.9)$$

- $\delta$  : Elastic deformation mm
- $P$  : Inner ring tightening force N
- $L$  : Inner ring spacer width mm
- $A$  : Inner ring cross-sectional area mm<sup>2</sup>
- $E$  : Young's modulus 210,000 MPa

The require tightening force exerted onto inner ring spacers varies depending on the bearing manufacturer. From its experience, NTN adopts the typical values listed in **Table 6.2**.

Table 6.2 Nut tightening force

Bearing bore diameter (mm)	Nut tightening force (N)	Nut tightening torque <reference value> (N·m)	Front cover drive-up (mm)
6	1470	2	0.01~0.02
8		2	
10		4	
12		5	
15	2900	8	
17		9	
20		10~17	
25		13~22	
30	2940~4900	15~26	
35		18~30	
40		34~68	
45		38~75	
50	4900~9800	42~83	
55		92~138	
60		100~150	
65		108~162	
70	9800~14700	116~174	
75		124~186	
80		199~331	
85		211~351	
90	14700~24500	223~372	
95		235~392	
100		247~412	
105		259~432	
110	24500~34300	271~452	
120		295~492	
130		319~532	
140		572~800	
150	24500~34300	613~858	
160		655~917	
170		695~973	
180		736~1031	
190	24500~34300	779~1090	
200		818~1145	
220		—	
240		—	
260	<reference value>	—	0.02~0.03
280	(34300~44100)	—	
300	—	—	
300	—	—	

- Note 1) NTN has specified the nut tightening forces in this table based on experiences from reviewing and assessing the drawings from users. However, NTN has no production record for bore diameter of 220 mm or larger. Thus, the nut tightening forces in parentheses are estimated values.
- Note 2) The nut tightening torque is calculated with a friction coefficient of 0.15 between the nut seating face and screw thread surface.
- Note 3) When tightening nuts, it is recommended to tighten them to twice the set value, then loosen them, and finally re-tighten them to the recommended set value.
- Note 4) For ball screw support bearings (BST), a tightening torque approximately 3 times as large as the preload is recommended.

#### ⑤ Front cover drive-up

When mounting and securing a bearing onto a main spindle, the inner ring is usually tightened with a stepped sleeve or precision bearing nut and the outer ring side is bolted down. When locking the outer ring with a front cover, the following points need to be considered.

##### ■ Front cover pressing amount

The bearing outer ring is tightened and locked between the shoulder of the housing and front cover at the main spindle front section. The front cover is installed by utilizing bolt holes (6 to 8 positions) on its flange. The usual pressing allowance on the outer ring and the front cover, which NTN has adopted through experience, falls in a range of 0.01 to 0.02 mm. Too large a pressing amount on the outer ring or a smaller number of fastening bolts may lead to poor roundness of the bearing ring.

Typical fit and deterioration in roundness of a raceway surface resulting from a pressing amount of 0.05 mm on the outer ring are shown in Fig. 6.14. Also, typical outer ring pressing amount and deterioration of a raceway surface with a fit of 5 μm loose are provided in Fig. 6.15.

To avoid deformation of the outer ring raceway surface, NTN recommends that the outer ring be installed to a highly accurate housing in transition fit with a large number of bolts.

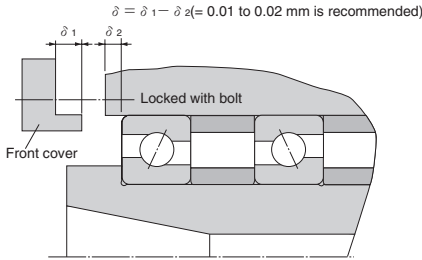


Fig. 6.12 Front cover pressing allowance

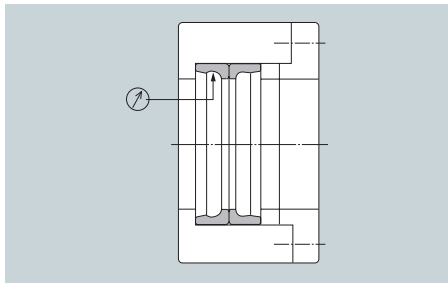


Fig. 6.13 Measuring position for roundness on outer ring raceway surface

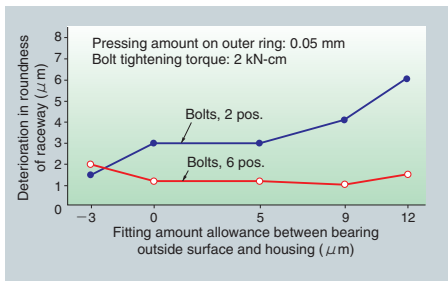


Fig. 6.14 Effect of fit of outer ring on roundness of raceway surface

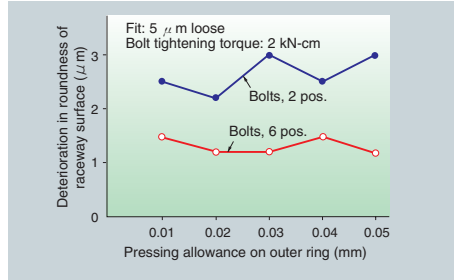


Fig. 6.15 Pressing allowance on outer ring vs. deterioration in roundness of raceway surface

## ⑥ Checking axial rigidity

In the typical method for checking for the axial rigidity of a bearing installed to a machine tool, the main spindle itself is pushed with a push-pull gage to measure the resultant axial displacement. A method using a dial indicator is described below.

Two dial indicator are placed on two locations (axisymmetric locations separated by 180°) at the leading end of the main spindle. Use magnetic stands to secure the dial indicator to the end face of housing. Then, apply the load onto the main spindle and the resultant axial displacement is measured.

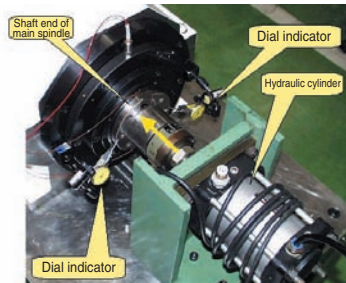


Photo 6.3

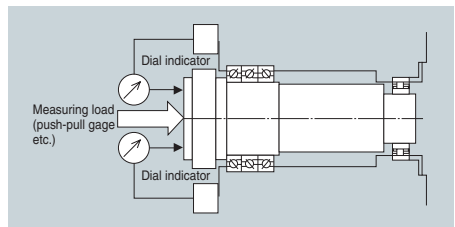


Fig. 6.16 Checking for axial rigidity

⑦ Clearance adjustment for cylindrical roller bearing

When incorporating a cylindrical roller bearing into a main spindle of a machine tool such as an NC turning machine or machining center, and setting the internal clearance to zero or to a negative clearance, the inner ring of the bearing usually has a tapered bore.

The internal clearance is adjusted by fitting the tapered bore bearing onto the tapered portion of the main spindle and driving the bearing in the axial direction to expand the inner ring.

For adjusting the internal clearance, two methods are available: a method consisting of clearance measurement for each bearing and adjustment with a spacer(s), and a method with a post-mounting internal clearance adjustment gage.

■ Method with clearance measurement and adjustment with spacer (s)

Adjust the bearing internal clearance by following the procedure described below:

(1) Calculation of outer ring shrinkage (see Fig. 6.17)

- Calculate the interference at the fitting area  $\Delta d_{eff}$  between the outer ring and housing.

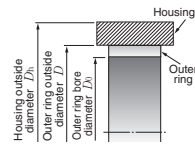


Fig. 6.17 Fit between outer ring and housing

Measure the housing bore diameter first, and then calculate the interference  $\Delta d_{eff}$  from the outer ring outside diameter listed on the bearing inspection sheet.

EX. 1

- Bearing outer ring outside diameter  $\phi 150$  mm (Inspection sheet = -0.005)
- Housing bore diameter  $D$   $\phi 150$  mm (measurement data = -0.007)
- Interference at fitting area  $\Delta d_{eff} = 0.002$  (2  $\mu$ m tight)

- Calculate the outer ring shrinkage  $\Delta G$  with the formula (6.10).

$$\Delta G = \Delta d_{eff} \cdot \frac{D_0}{D} \cdot \frac{1 - (D/D_0)^2}{1 - (D_0/D)^2 \cdot (D/D_0)^2} \dots\dots\dots (6.10)$$

EX. 2

Housing outside diameter  $D_h = \phi 200$ , outer ring outside diameter  $D = \phi 150$ , outer ring bore diameter  $D_0 = \phi 137$

$$\Delta G = 0.002 \cdot \frac{137}{150} \cdot \frac{1 - (150/200)^2}{1 - (137/150)^2 \cdot (150/200)^2} = 0.0015 \dots\dots (6.11)$$

(2) Measurement of bearing position and bearing radial clearance on a temporarily mounted bearing

- Mount the bearing inner ring with the cage and rollers onto the tapered shaft (see Fig. 6.18).

In this process, force the inner ring until its tapered bore face is fully seated, and then measure the distance between the shaft shoulder and inner ring side face ( $L_i$ ).

NOTE: After mounting the inner ring, check that the bearing side face is square to the main spindle centerline.

- At this point, mount the outer ring, move the outer ring up and down by hand and then measure the internal clearance after mounting ( $\Delta r_1$ ) (see Fig. 6.19).
- Calculate the estimated bearing clearance  $\Delta_1$  after press-fitting the outer ring into the housing with the formula (6.12). The result of the calculation reflects the outer ring shrinkage  $\Delta G$ .

$$\Delta_1 = \Delta r_1 - \Delta G \dots\dots\dots (6.12)$$

EX. 3

Internal clearance after mounting  $\Delta r_1 = 0.030$   
 Outer ring shrinkage  $\Delta G = 0.0015$   
 Estimated bearing clearance

$$\Delta_1 = 0.030 - 0.0015 = 0.0285$$

(3) Adjustment of spacer width between shaft shoulder and inner ring

To adjust the bearing clearance to a predetermined target value ( $\delta$ ) after mounting, determine the spacer width  $L_n$  with the formula (6.13) (refer to Figs. 6.20 and 6.21).

$$L_n = L_i + f (\delta - \Delta_1) \dots\dots\dots (6.13)$$

(n=2, 3, 4...)

The value f in the formula (6.13) is found in the table below.

Table 6.3 Value f

Value $d_m/d_i$	Value f
0 ~0.2	13
0.2~0.3	14
0.3~0.4	15
0.4~0.5	16
0.5~0.6	17
0.6~0.7	18

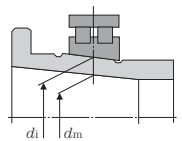


Fig. 6.21 Explanation of  $d_m/d_i$

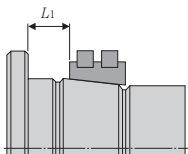


Fig. 6.18 Measurement of bearing position

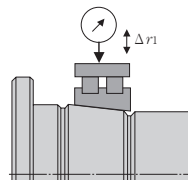


Fig. 6.19 Measurement of bearing radial clearance

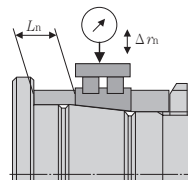


Fig. 6.20 Clearance measurement after insertion of spacer

**EX. 4**

In the case of NN3020K, if  $d = \text{dia. } \phi 100$ , width  $B = 37$ , and  $d_i = d + 1/12 \cdot B/2$ , then  $d_i = \text{dia. } \phi 101.54717$ .

If the targeted post-mounting clearance value  $\delta = 0.015$ ,  $L_1 = 15$ ,  $d_m = \text{dia. } \phi 60$ ,  $\Delta_1 = 0.0285$ , then  $d_m/d_i = 60/101.54717 = 0.5909$ , and, therefore,  $f = 17$ .

Thus, the spacer width  $L_n$  between the shoulder and inner ring equivalent to  $\delta = 0.015$  will be the value shown by the formula below:

$$L_n = 15 + 17 \times (0.015 - 0.0285) = 14.7705$$

**(4) Bearing clearance measurement after insertion of spacer (see Fig. 6.20)**

Insert a spacer that satisfies the spacer width  $L_n$  between the shoulder and inner ring determined in the previous step, and tighten the inner ring until the spacer does not move. Next, move the bearing outer ring up and down by hand and measure the internal clearance after mounting (post-mounting internal clearance)  $\Delta r_n$ . The estimated bearing clearance  $\Delta_n$  after press-fitting of the outer ring into the housing is determined with the formula below:

$$\begin{aligned} (n=2, 3, 4 \dots) \\ \Delta_n = \Delta r_n - \Delta \sigma \dots \dots \dots (6.14) \end{aligned}$$

**(5) Final adjustment for spacer width**

- Repeat the steps (3) and (4) above to gradually decrease the spacer width  $L_n$  so as to adjust the post-mounting bearing clearance to the targeted clearance.
- By plotting the correlation between the spacer width and post-mounting clearance as illustrated in Fig. 6.22, the spacer width for the final targeted clearance will be more readily obtained.

Positive clearance:

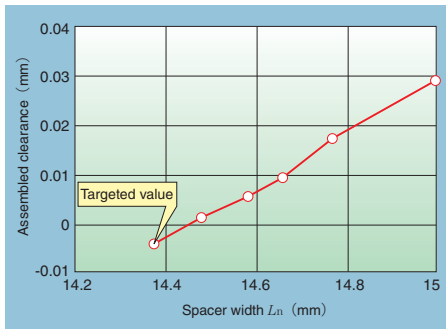
All rollers are sliding rather than rolling.

Clearance = 0:

About half of the rollers are rolling but the rest are sliding.

Negative clearance:

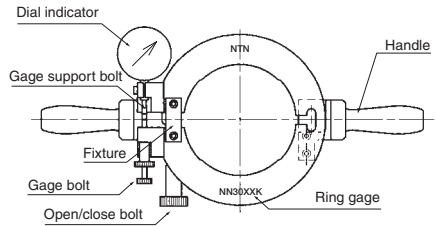
All rollers are rolling.



**Fig. 6.22 Correlation between spacer width  $L_n$  and post-mounting clearance  $\Delta_n$**

**Measurement with mounted internal clearance gage**

The mounted internal clearance gage has a cylindrical ring, which has a cut-out so that the ring can be opened and closed. The bore surface of the ring is used as a location for measurement. The clearance at the location for measurement is proportional to the reading on the dial indicator. As illustrated in Fig. 6.23, the clearance gage consists of a ring gage, dial indicator, and attachment components. Its fixture protects the interference gage against possible deformation when not in use. For the measuring operation, detach the fixture.



**Fig. 6.23 Descriptions of various components on mounted internal clearance measurement gage**

**Usage of mounted internal clearance gage**

**(1) Measurement of outer ring raceway diameter (bore diameter)**

- Mount the outer ring into the housing. (For easy mounting, heat the housing.)
- Wait until the temperature of the outer ring is same as that of the inner ring, and then measure the outer ring raceway diameter (bore diameter). Take measurements at several points and calculate the average, and then zero the gage at this average value.



**Photo 6.4**

**(2) Setup of mounted internal clearance gage**

- Place the cylinder gage, onto the bore surface of clearance adjustment gage as shown in **Photo 6.5**, and adjust it with the open/close bolt so that its dial 1 is set to zero (see **Photo 6.6**).
- When the reading of dial 1 of the cylinder gage is zero, adjust the gage bolt so that the pointer of dial 2 points at the red mark (correction amount of the gage). (**Photo 6.6**)

With the gage bolt, adjust the gage so that the short pointer is situated at the scale 2 position. (With the large size, insert the pin into the hole of the open/close bolt and make fine-adjustment.)

NOTE 1) **Photo 6.6** shows the inner ring and rollers. When the correction amount of the gage is adjusted, adjust it only with the thickness gage.

NOTE 2) The pointer of dial 2 is directed to the red mark. The purpose of this is to compensate clearance error caused due to the structure of mounted internal clearance gage. The correction amount can vary from gage to gage.

NOTE 3) When the pointer of dial 2 is in line with the red mark, the zero reading on dial 2 coincides with the zero bearing clearance.

**(3) Setting up the mounted internal clearance gage on the main spindle**

- Mount the inner ring onto the main spindle, and lightly tighten the bearing nut.
- Tightening the open/close bolt (see **Fig. 6.23**) on the clearance adjustment gage will cause the gage bore to expand.

With the gage bore expanded by about 0.15 mm, insert the gage into the outside diameter portion of the roller set in the inner ring. Be careful not to damage the rollers (**Photo 6.7**).

- Loosening the open/close bolt will cause the gage bore to shrink.

Loosen the open/close bolt to bring the gage bore into contact with the outside diameter of the ball set in the inner ring.

- Lightly swing the clearance adjustment gage in the circumferential direction to stabilize the pointer on the dial indicator.

**(4) Setup of inner ring clearance**

- Tighten the shaft nut of the main spindle. This should be done gradually to prevent shock loading.
- Tightening the nut further until the reading on the dial of the clearance adjustment gage becomes zero in case the clearance is aimed at 0  $\mu\text{m}$ .
- Once the reading on gage gets zero, carefully swing the adjustment gage again to check that the measurement value is correct.
- Loosen the open/close bolt on the clearance adjustment gage to expand the gage bore and remove the gage from the inner ring.

**(5) Determination of spacer width**

- The inner ring should now be in the position where the reading on the dial of clearance adjustment gage was zero in step (4). By using a block gage, measure

the distance between the inner ring side face and shaft shoulder (dimension  $\ell$  in **Fig. 6.24**).

- Measure this dimension in at least three locations, and finally adjust the spacer width  $\ell$  to the average of three measurements.
- Loosen and remove the shaft nut, inner ring spacer and inner ring from the main spindle.

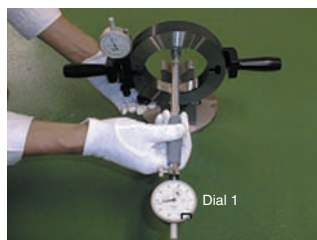


Photo 6.5



Photo 6.6



Photo 6.7

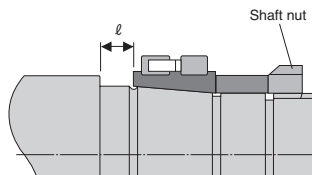


Fig. 6.24 Spacer width dimension

**(6) Assembly and check of the mounted roller outside diameter**

- Insert a spacer of width  $l$ . Then insert the inner ring and mounting spacer and tighten the shaft nut.
- According to a procedure similar to that in steps (3) "Setting up the mounted internal clearance gage on the main spindle" and (4) "Setup of inner ring clearance", check the mounted roller outside diameter and the clearance setting. Note this process is only a re-check procedure, and may be omitted once the clearance measurements fall in a smaller range.

**● Clearance correction factor and mounted internal clearance reading**

**(1) Clearance correction factor**

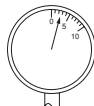
Because of the structure of the NTN mounted internal clearance adjustment gage, the ratio of the clearance reading on location for measurement to the reading on dial indicator is 1:2.5 (clearance indication factor). The clearance reading on the dial indicator is 2.5 times as large as the remaining internal clearance. For reference, a clearance reading conversion table is given in **Table 6.4**.

**NOTE: Note that the clearance correction factor of certain bearing numbers is not 1:2.5. Correction factor is given on the table of inspection results.**

**(2) Remaining internal clearance (where clearance indication value 1:2.5)**

The reading on the dial indicator is converted into a mounted internal clearance in the following manner:

- CASE 1: The reading relative to the zero point is in the clockwise direction (CW) (**Fig. 6.25**). The value of the mounted internal clearance (+) is 1/2.5 times as large as the reading on dial gage.



**Fig. 6.25**

Reading on dial gage in **Fig. 6.25** = 2.5

Remaining internal clearance =  $2.5/2.5 = (+)1 \mu\text{m}$

- CASE 2: The reading relative to the zero point is in the counterclockwise direction (CCW) (**Fig. 6.26**). The value of the mounted internal clearance (-) is

1/2.5 times as large as the reading on dial gage.

Reading on dial gage in **Fig. 6.26** = 5.0

Remaining internal clearance =  $5.0/2.5 = (-)2 \mu\text{m}$

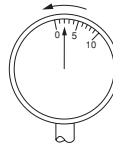


**Fig. 6.26**

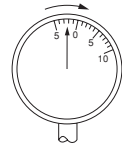
**● Setup of mounted internal clearance**

When setting the mounted internal clearance to a specific negative or positive value, the zero point on dial indicator by a value [targeted clearance multiplied by 2.5] may be shifted prior to the setup of the clearance adjustment gage. (In case that the mounted clearance value is divided by the correction factor, it is not necessary to the value [targeted clearance multiplied by 2.5])

(2.5: clearance correction factor)



**Fig. 6.27 Adjustment for negative clearance (remaining internal clearance:  $-0.8 \mu\text{m}$ )**



**Fig. 6.28 Adjustment for positive clearance (remaining internal clearance:  $+1.0 \mu\text{m}$ )**

**Precautions for using and storing the mounted internal clearance adjustment gage**

When using the mounted internal clearance adjustment gage, follow the precautions described below:

- When transferring the outer ring raceway diameter measured with the cylinder gage to the mounted internal clearance adjustment gage, use the adjustment gage in a vertical attitude (**Photo 6.8**).
- When not using the mounted internal clearance adjustment gage, place it in a horizontal attitude (**Photo 6.9**). Also, after completion of clearance measuring operation, apply rust-preventive oil to the internal clearance adjustment gage and store in a dry location.

**Table 6.4 Clearance reading conversion table**

Reading on dial gage ( $\mu\text{m}$ )	Remaining internal clearance on location for measurement ( $\mu\text{m}$ )	Reading on dial gage ( $\mu\text{m}$ )	Remaining internal clearance on location for measurement ( $\mu\text{m}$ )
0.5	0.2	5.5	2.2
1.0	0.4	6.0	2.4
1.5	0.6	6.5	2.6
2.0	0.8	7.0	2.8
2.5	1.0	7.5	3.0
3.0	1.2	8.0	3.2
3.5	1.4	8.5	3.4
4.0	1.6	9.0	3.6
4.5	1.8	9.5	3.8
5.0	2.0	10.0	4.0



**Photo 6.8 Vertical storage attitude**



**Photo 6.9 Horizontal storage attitude**



### ⑧ Tapered bore cylindrical roller bearing and main spindle taper angle

In order for a precision bearing to perform as designed, it must be correctly mounted to a shaft and housing. In particular, when employing a tapered bore cylindrical roller bearing, accurate finish for the tapered main spindle and appropriate fit between the bearing bore and the main spindle are very important to ensure high accuracy of the main spindle. NTN recommends that the customer use the NTN tapered shaft ring gage, which that is finished to same accuracies as the bearing, so that the customer can achieve higher precision. NTN also offers a plug gage so that the customer can check the accuracy of the ring gage.

#### ■Taper gage for precision roller bearings

Each NTN precision cylindrical roller bearing taper gage consists of a female gage and a male gage (plug gage) (Fig. 6.29).

Using blue paste or an equivalent as well as a ring gage, check the fit of the bearing bore with the main spindle taper. The correct fit between the main spindle and the bearing leads to higher accuracy of the main spindle. The plug gage is intended to check the accuracy of the associated ring gage. Use the plug gage to verify the taper accuracies of the associated ring gage (Fig. 6.30).

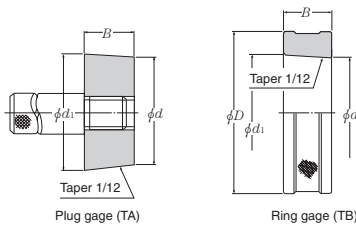


Fig. 6.29 Taper gage

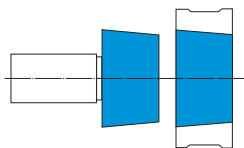


Fig. 6.30 Blue paste on taper gage

#### ■Taper angle

NTN machines the tapered bore of its cylindrical roller bearings and the taper angle of its taper gages according to the tolerances below:

- Nominal taper angle 1/12 ( $4^{\circ} 46' 18.8''$ )
- Tolerance for precision roller bearing with 1/12 taper angle is  $+12'' \pm 12''$  (JIS class 4 and 2)
- Targeted tolerance for taper gage 1/12 is  $+9''$ .

Usually, Using blue paste between the tapered bore of a cylindrical roller bearing and a plug gage exhibits a strong contact mark on the small diameter side as show in Fig. 6.31. This is because NTN has slightly adjusted the taper angle of the bearing bore to accommodate for the difference in thickness of the inner ring below each row of rollers.

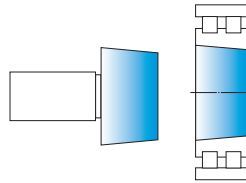


Fig. 6.31

#### ■Checking main spindle taper with ring gage

When checking the main spindle taper angle with a ring gage, perform the following steps.

- Thoroughly clean the surface of the ring gage, and apply a thin layer of blue paste to four equally-spaced points.
- Clean the tapered surface of the shaft, and gently insert into the ring gage.
- The ring gage to be lightly turning it.
- Check the patterns of blue paste deposited on the shaft surface.
- At this point, attach a strip of clear adhesive tape onto each blue paste spot, and peel off each strip.

Attach strips of adhesive tape onto white paper and check how much blue paste was deposited onto each point. Check that more than 80% of the applied blue paste was deposited on the tapered surface.

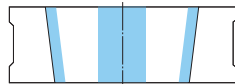


Fig. 6.32 Application of blue paste to ring gage

Table 6.5 Examples of blue paste records

Region A	Small	Large
Region B	Small	Large
Region C	Small	Large
Region D	Small	Large

Small: small diameter side  
Large: large diameter side

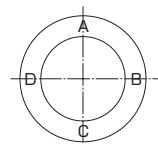


Fig. 6.33 Regions subjected to measurement with blue paste

### 9 Running-in operation for main spindle bearings

Run-in is important for ensuring smooth operation of grease-lubricated main spindle bearings.

The following two modes of running-in are recommended:

- (1) The bearing speed is gradually increased in steps. After the temperature is saturated at each speed setting, the speed is increased to the next step (Fig. 6.34).
- (2) The bearing is run for one minute at around the maximum operating speed of the spindle. This cycle is repeated two or three times (Fig. 6.35) as needed.

(1) is the ordinary method used, however it takes slightly longer to reach the maximum operating speed of the spindle. In contrast, (2) can shorten the running-in time, however higher risk of sudden bearing temperature increase is considerable, so that running speed and its holding time must be set carefully.

Generally, the temperature of a main spindle bearing is measured on the front cover. The temperature difference across the bearing outer ring and front cover reaches 2 to 3°C, and at the same time, the temperature difference between the hottest rolling element and the inner ring raceway surface seems to reach 50 to 10°C. For this reason, NTN recommends that the machine is stopped if the temperature on front cover reaches approximately 60°C. The machine should be allowed to cool off before the running-in operation is restarted.

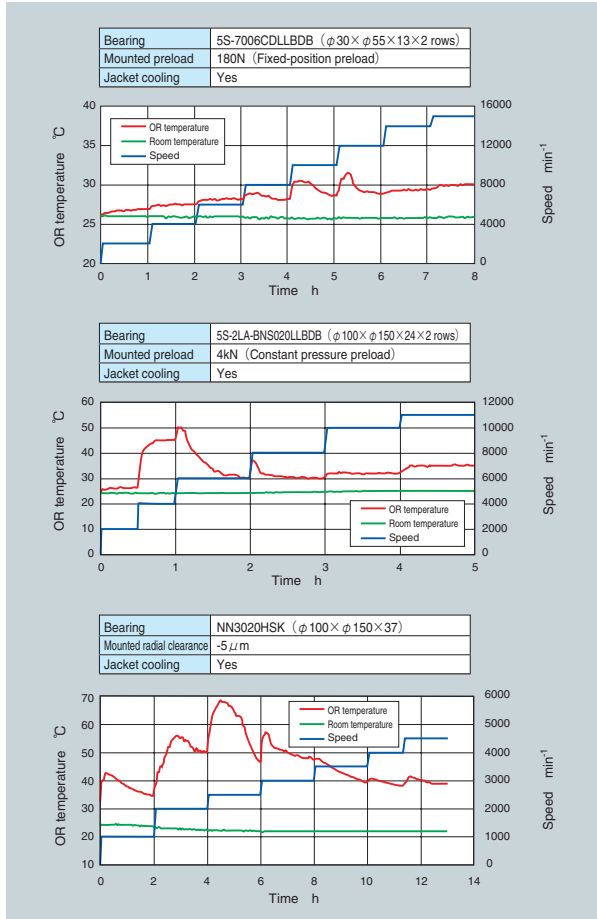


Fig. 6.34

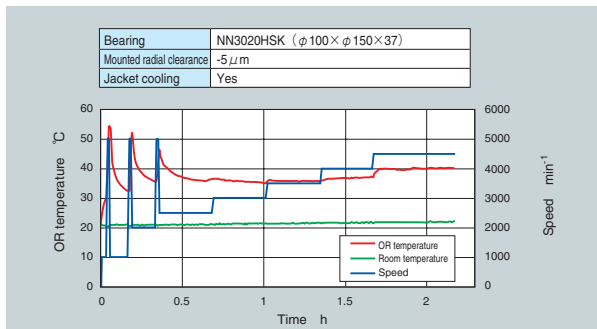


Fig. 6.35

## 7. Lubrication of Bearings

In a bearing, lubrication forms a thin oil film on both rolling and sliding surfaces to prevent metal-to-metal contact. The benefits of lubrication can be summarized as follows:

- (1) Alleviation of friction and wear
- (2) Removal of heat due to friction
- (3) Longer bearing life
- (4) Rust prevention
- (5) Protection against contamination by foreign material

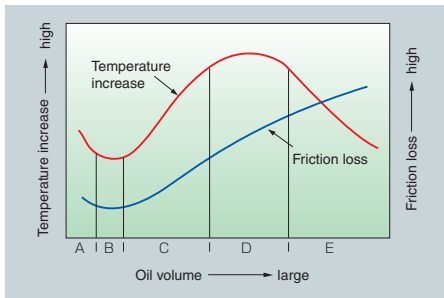


Fig. 7.1

Table 7.1 Oil volume, friction loss and bearing temperature (Fig. 7.1)

Zone	Features	Typical lubrication method
A	With an extremely low volume of oil, partial metal-to-metal contact occurs between the rolling elements and raceway surface, possibly leading to abnormal wear and bearing seizure.	---
B	A uniform, uninterrupted oil film is formed. Friction is minimal and bearing temperature is kept low.	Grease lubrication Oil mist lubrication Air-oil lubrication
C	Even with a greater oil volume, heat generation and cooling are in balance.	Circulating lubrication
D	Temperature increase is constant regardless of oil volume.	Circulating lubrication
E	A further increase in oil volume contributes to a significant cooling effect, and the bearing temperature drops.	Forced circulating lubrication Jet lubrication

To achieve the full lubricating effect, it is necessary to use a lubricating system suited to the operating conditions, select a quality lubricant, remove dust from the lubricant, and design an appropriate sealing structure to prevent contamination as well as lubricant leakage.

The main spindle of a machine tool usually uses an extremely low volume of lubricant so heat generation from stirring of the lubricant is minimal.

Fig. 7.1 summarizes the relationships between oil volume, friction loss, and bearing temperature.

The lubrication methods available for bearings in a machine tool include grease lubrication, oil mist lubrication, air-oil lubrication, and jet lubrication. Each method has unique advantages. Therefore, the lubricating system that best suits the lubrication requirements should be used.

Tables 7.1 and 7.2 summarize the features of various lubrication methods.

Table 7.2 Evaluation of various lubricating systems

Lubrication method	Grease lubrication	Oil mist lubrication	Air-oil lubrication	Jet lubrication
Criterion				
Handling	☆☆☆☆	☆☆☆	☆☆☆	☆☆
Reliability	☆☆☆	☆☆	☆☆☆	☆☆☆☆
Temperature increase	☆☆	☆☆	☆☆☆	☆☆☆☆
Cooling effect	☆	☆☆	☆☆☆	☆☆☆☆
Sealing structure	☆☆	☆☆☆	☆☆☆	☆
Power loss	☆☆☆	☆☆☆	☆☆☆	☆
Environmental contamination	☆☆☆	☆	☆☆	☆☆☆
Allowable $d_{mh}$ value ●	$1.4 \times 10^6$	$2.2 \times 10^6$	$2.5 \times 10^6$	$4.0 \times 10^6$

Legend ☆☆☆☆: Excellent ☆☆☆: Good ☆☆☆: Fair ☆: Poor

● The permissible  $d_{mh}$  values are approximate values:

$d_{mh}$ : pitch circle diameter across rolling elements [mm] multiplied by speed [min<sup>-1</sup>]

## ① Grease lubrication

Grease lubrication is the most common, as it simplifies the main spindle structure more than other lubricating systems. With an adequate amount of quality grease pre-filled, this system can be used over a wide range of speed. The allowable maximum speed varies with the type and size of bearing: for a high-speed angular contact ball bearing, the  $d_{min}$  value should be  $1.4 \times 10^6$  as a guideline. For applications exceeding this range, consult NTN Engineering.

### ■ Grease types

A lithium-based grease, with a mineral oil base, is commonly used as a lubricant for rolling bearings. Its operating temperature range is  $-30^{\circ}\text{C}$  to  $130^{\circ}\text{C}$ .

When the temperature increase must be limited, as with the main spindle of a machine tool, NTN recommends the use of a synthetic-oil-based grease (diester, diester+mineral oil) which penetration is NLGI grade 1 or 2.

**Table 7.3** lists technical data for greases commonly used for machine tool main spindles.

### ■ Amount of grease required

Usually, a bearing for the main spindle of a machine tool requires that grease volume be low so heat generated by the stirring of the grease during high-speed operation is minimal. A guideline for the amount of grease used for a main spindle bearing is given below.

- Angular contact ball bearing  
( $d_{min}$  value  $\leq 0.65 \times 10^6$ ); 15% of bearing free space  
( $d_{min}$  value  $> 0.65 \times 10^6$ ); 12% of bearing free space
- Cylindrical roller bearing; 10% of bearing free space
- Tapered roller bearing; 15% of bearing free space

The space in the bearing typically used for main spindles are listed in dimension tables. Determine a fill amount by referring to the relevant dimension table.

Before filling a bearing with grease, remove the rustproof coating from the bearing with clean wash oil and allow the bearing to dry completely. Then fill and uniformly distribute an appropriate amount of grease in the bearing with an syringe, plastic bag, etc.

**Table 7.3 Typical greases for machine tool main spindle bearings**

Grease brand	SE-1	MP-1	ISOFLEX NBU15	Stablugs NBU 8EP	Multemp LRL3	Multemp PS2	ISOFLEX LDS18
Thickener	Urea		Ba complex soap		Li soap		
Base oil	Ester	Synthetic oil	Ester	Mineral oil	Synthetic oil	Diester+mineral oil	Synthetic oil
Base oil viscosity (40°C) mm <sup>2</sup> /S	22	40.6	20	105	37.3	15.3	16
Dropping point °C	>220	254	>200	220	208	190	>180
Operating temperature range °C	-50~+120	-40~+150	-60~+130	-35~+150	-40~+150	-55~+130	-60~+130
Application	Applied to ULTAGE Series grease-lubricated sealed angular contact ball bearings	Applied to ULTAGE Series grease-lubricated sealed angular contact ball bearings	Most commonly used for main spindles	Suitable for roller bearings subject to large loads	Wider operating temperature range	Excellent low temperature and friction characteri- stics	Suitable for ball bearing
NTN grease code	L749	L448	15K	L135	12K	1K	6K

## ② Air-oil lubrication

Air-oil lubrication (also known as oil-air lubrication or oil and air lubrication) is widely adopted for main spindle bearings in order to cope with the higher speed and precision of machine tools and to ensure more reliable lubrication.

Air-oil lubrication employs a method by which compressed air is used to provide lubricating oil in precisely controlled amounts. Generally, an air-oil lubrication unit a volumetric piston-type distributor that accurately meters the required minimum amount of lubricating oil and provides it at optimal intervals controlled by a timer.

### ■ Special features of air-oil lubrication

Air-oil lubrication has the following advantages over conventional oil mist lubrication:

- Accurately supplies a minimal amount of oil.
- Can be adjusted to provide the proper amount of lubricant for individual bearings.
- No limitations exist regarding lubricant viscosity and extreme pressure additives.
- Compressed air helps cool the bearing.
- Variations in the distance and height of lubrication points do not affect lubrication efficiency.
- Health hazards of oil mist are minimized.
- Low oil consumption.
- Use of compressed air can prevent contamination of the bearing by other coolants.
- The recommended oil viscosity is 10 to 32 mm<sup>2</sup>/s.

### ■ Example of an air-oil lubrication unit

Fig. 7.2 shows the structure of an air-oil lubrication unit.

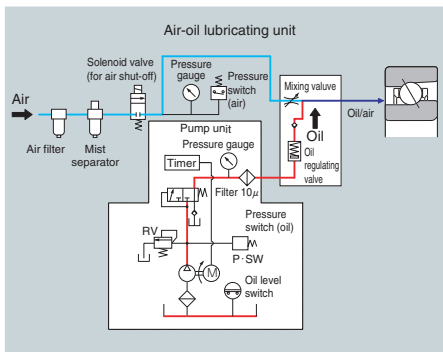


Fig. 7.2 Air-oil lubricating system

### ■ Air-oil lubrication nozzle spacer

Air-oil lubrication requires a specialized nozzle because it supplies the lubricating oil to the inside of the bearing by means of compressed air. (Fig. 7.3)

A nozzle with a hole diameter of 1.0 to 1.5 mm and a length 4 to 6 times the hole diameter is recommended.

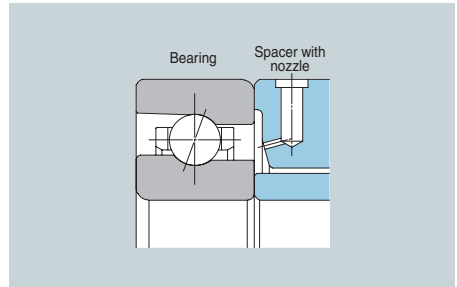


Fig. 7.3 Feed system for air-oil lubrication

### ■ Exhaust method for air-oil lubrication

Air-oil lubrication uses a large volume of air to feed lubricating oil to the bearing. Therefore, it is essential that the air fed into the bearing be allowed to escape. If the air is not smoothly exhausted, the lubricating oil will remain in the bearing and possibly contribute to bearing seizure. In the design stage, remember to allow ample space on the exhaust side of the bearing in order to increase exhaust efficiency and provide a larger oil drain hole to ensure smooth airflow. In addition, for types that allow for repositioning of the spindle, it is recommended that the shoulder dimensions of all parts is designed to prevent lubricating oil from flowing back into the bearing after a change in the attitude of the main spindle. Unnecessary dimensional differences can also contribute to stagnancy of the lubricating oil.

■ Recommended targeted position with nozzle

(1) Angular contact ball bearings

**Table 7.4 Air-oil/oil mist nozzle spacer dimensions**

Note: Spacer dimensions are the same for all contact angles (15°, 25° and 30°).

Bearing No.	$\theta$	<i>A</i>	Outer diameter of inner ring spacer	Inner diameter of outer ring spacer	<i>D</i>	<i>E</i>
7900U	15°	14.6	12.4	13.4	18.5	1
7901U	15°	16.6	14.4	15.4	20.5	1
7902U	15°	19.5	17.2	18.2	25	1
7903U	15°	21.5	19.2	20.2	27	1
7904U	15°	26.3	24	25	32.5	1
7905U	15°	31.3	29	30	37.5	1
7906U	15°	36.3	34	35	42.5	1
7907U	15°	41.5	39.2	40.2	50.5	1
7908U	15°	48.1	45.8	46.8	56.5	1
7909U	15°	52.8	50.5	51.5	63	1
7910U	15°	57.3	54.3	55.8	67.5	1.5
7911U	15°	64.1	61.1	62.6	73.5	1.5
7912U	15°	69.1	66.1	67.6	78.5	1.5
7913U	15°	74.1	71.1	72.6	84	1.5
7914U	15°	80.9	77.9	79.4	93	1.5
7915U	15°	85.9	82.9	84.4	97.5	1.5
7916U	15°	91.4	88.4	89.9	103	1.5
7917U	15°	97.4	94.4	95.9	112	1.5
7918U	15°	102.4	99.4	100.9	117	1.5
7919U	15°	107.4	104.4	105.9	122	1.5
7920U	15°	113.9	110	112	131	1.5
7921U	15°	118.9	115	117	136	1.5
7922U	15°	123.9	120	122	141	1.5
7924U	15°	135.4	132	134	155	1.5
7926U	15°	146.9	143	145	169	1.5
7000U	15°	15.4	13.1	14.1	22	1
7001U	15°	18.1	15.8	16.8	24.5	1
7002U	15°	21.3	19	20	27.5	1
7003U	15°	23.3	21	22	31	1
7004U	15°	28.6	25.8	26.8	37.5	1
7005U	15°	33.1	30.5	31.5	41.5	1
7006U	15°	39.6	36.5	37.5	49.5	1
7007U	15°	44.6	41	42	56	1
7008U	15°	50.4	47	48	61.5	1
7009U	15°	55.9	52	54	67.5	1
7010U	15°	60.9	57	59	72.5	1.5
7011U	15°	67.4	63	65	82	1.5
7012U	15°	72.4	68	70	87	1.5
7013U	15°	77.4	73	75	92	1.5
7014U	15°	83.9	78	80	101	1.5
7015U	15°	88.9	83	85	106	1.5
7016U	15°	95.4	90	92	115	1.5
7017U	15°	100.4	95	97	120	1.5
7018U	15°	106.9	101	103	129	1.5
7019U	15°	111.9	106	108	134	1.5
7020U	15°	116.9	112	114	139	1.5
7021U	15°	123.4	117	120	148	1.5
7022U	15°	129.9	122	125	157	1.5
7024U	15°	139.9	133	136	167	1.5
7026U	15°	153.9	143	146	184	1.5

**Table 7.5 Air-oil/oil mist nozzle spacer dimensions**

Note: Spacer dimensions are the same for all contact angles (15°, 20° and 25°).

Bearing No.	$\theta$	<i>A</i>	Outer diameter of inner ring spacer	Inner diameter of outer ring spacer	<i>D</i>	<i>E</i>
HSE910U	15°	58.9	55	56	67	1.5
HSE911U	15°	64.8	61	62	74	1.5
HSE912U	15°	69.8	66	67	79	1.5
HSE913U	15°	74.8	71	72	84	1.5
HSE914U	15°	81.6	77	79	93	1.5
HSE915U	15°	86.6	82	84	98	1.5
HSE916U	15°	91.6	87	89	103	1.5
HSE917U	15°	98.1	93	95	112	1.5
HSE918U	15°	103.1	98	100	117	1.5
HSE919U	15°	108.1	103	105	122	1.5
HSE920U	15°	115.3	109	111	131	1.5
HSE921U	15°	120.3	114	116	136	1.5
HSE922U	15°	125.3	119	121	141	1.5
HSE924U	15°	136.9	130	132	155	1.5
HSE926U	15°	148.4	141	143	169	1.5
HSE928U	15°	158.4	151	153	179	1.5
HSE930U	15°	172.1	164	166	196	1.5
HSE932U	15°	182.1	174	176	206	1.5
HSE934U	15°	192.1	184	186	216	1.5
HSE010	15°	61.6	57	59	73	1.5
HSE011	15°	69.7	63	65	82	1.5
HSE012	15°	74.7	68	70	87	1.5
HSE013	15°	79.7	73	75	92	1.5
HSE014	15°	86.9	76	80	101	1.5
HSE015	15°	91.9	83	85	106	1.5
HSE016	15°	99.2	90	92	115	1.5
HSE017	15°	104.2	95	97	120	1.5
HSE018	15°	111.4	101	103	129	1.5
HSE019	15°	116.4	106	108	134	1.5
HSE020	15°	121.4	112	114	138	1.5
HSE021	15°	128.7	117	119	148	1.5
HSE022	15°	135.2	122	126	158	1.5
HSE024	15°	145.2	133	136	167	1.5
HSE026	15°	158.5	143	149	187	1.5
HSE028	15°	170.8	153	160	197	1.5
HSE030	15°	181.5	165	171	210	1.5
HSE032	15°	193.2	175	183	225	1.5
HSE034	15°	207.8	185	197	245	1.5

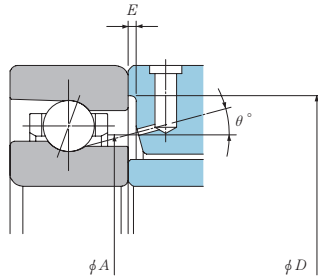


Fig. 7.4 7U, HSE, BNT and HTA types

Table 7.6 Air-oil/oil mist nozzle spacer dimensions

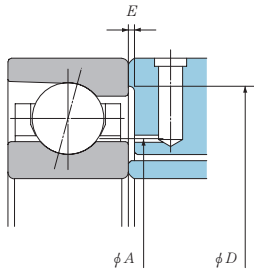
Bearing No.	$\theta$	A	Outer diameter of inner ring spacer	Inner diameter of outer ring spacer	D	E
BNT900	12°	14.3	12.2	13.2	18.5	1
BNT901	12°	16.3	14.2	15.2	20.5	1
BNT902	12°	19.2	17.1	18.1	24	1
BNT903	12°	21.2	19.1	20.1	26	1
BNT904	12°	26	23.5	24.5	32.5	1
BNT905	12°	31	28.5	29.5	37.5	1
BNT906	12°	35.8	33.5	34.5	42.5	1
BNT907	12°	41.1	38.5	39.5	50	1
BNT908	12°	47.1	44.4	45.4	56	1
BNT909	12°	52.3	49	50	61.5	1
BNT000	15°	15.1	13	14	22	1
BNT001	15°	17.7	15.6	16.6	24	1
BNT002	15°	21	18.6	19.6	28	1
BNT003	15°	22.9	20.6	21.6	30	1
BNT004	15°	28.1	25	26	37	1
BNT005	15°	32.6	30.5	31.5	41.5	1
BNT006	15°	39.1	35.5	36.5	49.5	1
BNT007	15°	44	41	42	56	1
BNT008	15°	49.8	47	48	61	1
BNT009	15°	55.2	52	53	68	1
BNT200	15°	17.5	15.4	16.4	24.5	1
BNT201	15°	18.9	16.8	17.8	26.5	1
BNT202	15°	21.4	19.3	20.3	29	1
BNT203	15°	24.6	22	23	34	1
BNT204	15°	30	26.5	27.5	40.5	1
BNT205	15°	34.8	32	33	45.5	1
BNT206	15°	40.9	37.5	38.5	54.5	1
BNT207	15°	46.6	43.5	44.5	64	1
BNT208	15°	52.5	49	50	71.5	1
BNT209	15°	56.9	54.5	55.5	76.5	1

Table 7.7 Air-oil/oil mist nozzle spacer dimensions

Note: Spacer dimensions are the same for all contact angles (30° and 40°).

Bearing No.	$\theta$	A	Outer diameter of inner ring spacer	Inner diameter of outer ring spacer	D	E
HTA920	15°	116.4	110	112	130	1.5
HTA921	15°	121.4	115	117	135	1.5
HTA922	15°	126.4	120	122	140	1.5
HTA924	15°	138.7	132	134	153	1.5
HTA926	15°	151	143	145	167	1.5
HTA928	15°	161	153	155	177	1.5
HTA930	15°	174.9	165	167	195	1.5
HTA932	15°	184.9	175	177	205	1.5
HTA934	15°	194.9	185	187	215	1.5
HTA936	15°	208.1	197	199	233	1.5
HTA938	15°	218.1	208	210	242	1.5
HTA940	15°	232.5	220	222	260	1.5
HTA006	15°	39.5	35.5	36.5	49.5	1
HTA007	15°	44.3	41	42	56	1
HTA008	15°	49.9	47	48	61	1
HTA009	15°	56.1	52	53	68	1
HTA010	15°	61.1	57	59	73	1.5
HTA011	15°	69.3	63	65	82	1.5
HTA012	15°	74.3	68	70	87	1.5
HTA013	15°	79.3	73	75	92	1.5
HTA014	15°	86.4	78	80	101	1.5
HTA015	15°	91.4	83	85	106	1.5
HTA016	15°	98.7	90	92	115	1.5
HTA017	15°	103.7	95	97	120	1.5
HTA018	15°	111	101	103	129	1.5
HTA019	15°	116	106	108	134	1.5
HTA020	15°	121	112	114	138	1.5
HTA021	15°	128.4	117	119	148	1.5
HTA022	15°	134.9	122	126	158	1.5
HTA024	15°	144.9	133	136	167	1.5
HTA026	15°	158.1	143	149	187	1.5
HTA028	15°	170.4	153	160	197	1.5
HTA030	15°	181.2	165	171	210	1.5
HTA032	15°	192.7	175	183	225	1.5
HTA034	15°	207.4	185	197	245	1.5

(a) When lubricant is supplied between the cage and inner ring



(b) When lubricant is supplied between the cage and outer ring

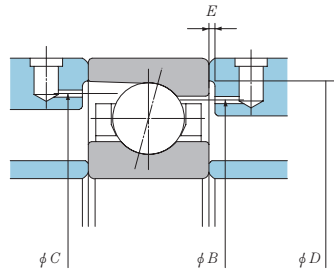


Fig. 7.5 78C, 79C, 70C and 72C types

Table 7.8 Air-oil/oil mist nozzle spacer dimensions

Bearing No.	(b) When lubricant is supplied between the cage and outer ring					
	B	C	Outer diameter of inner ring spacer	Inner diameter of outer ring spacer	D	E
7805C	32.6	33.3	28	29	34	1
7806C	37.6	38.2	33	34	39	1
7807C	42.6	43.1	38	39	44	1
7808C	47.8	48.4	43	44	49	1
7809C	53.2	54.3	48.5	49.5	54	1
7810C	59.5	60.2	54	55	60.5	1
7811C	66.2	67.4	59	61	68	1
7812C	71.7	72.8	64.5	66.5	73.5	1
7813C	77.7	78.7	70.5	72.5	79.5	1
7814C	82.4	83.6	75.5	77.5	84.5	1
7815C	87.8	88.8	80.5	82.5	89.5	1
7816C	92.5	93.6	85.5	87.5	94.5	1
7817C	101	102.5	91.5	93.5	103.5	1
7818C	106	107.3	96.5	98.5	108.5	1
7819C	111	112.4	101.5	104	113.5	1
7820C	115.6	117	106.5	110	118.5	1
7821C	120.7	122	111.5	115	123.5	1
7822C	129.2	131.1	117.5	122	132.5	1
7824C	139.2	141.1	127.5	132	142.5	1
7826CT1	152.3	154.5	139	144	156.5	1.5
7828CT1	162.3	164.5	149	155	166.5	1.5
7830CT1	175.3	177.8	160.5	167.5	180.5	1.5
7832CT1	185.5	188	170.5	177.5	190.5	1.5
7834CT1	198.7	201.5	181	188	204.5	1.5
7928CT1B	171.3	176.9	153	163	179	1.5
7930CT1B	187.2	193.8	165	179	197	1.5
7932CT1B	198.3	201.9	175	190	205	1.5
7934CT1B	208.2	211.9	185	200	215	1.5



7805C~7834CT1, 7928CT1B~7934CT1B, 7200C~7218C .....B is recommended.  
 7028CT1B~7040CT1B, 7219C~7226C .....A is recommended.  
 If targeting at A is impossible, B is acceptable. If both A and B are impossible, targeting from C is acceptable.

**Table 7.9 Air-oil/oil mist nozzle spacer dimensions**

Bearing No.	(a) When lubricant is supplied between the cage and inner ring			(b) When lubricant is supplied between the cage and outer ring				Common to (a) & (b)	
	A	Outer diameter of inner ring spacer	Inner diameter of outer ring spacer	B	C	Outer diameter of inner ring spacer	Inner diameter of outer ring spacer	D	E
7200C	—	—	—	23	23.8	15.5	17.5	25	1
7201C	—	—	—	24.9	25.8	17.5	19.5	27	1
7202C	—	—	—	28.3	29.4	20.5	22.5	30	1
7203C	—	—	—	32.4	33.7	23.5	26.5	35	1
7204C	—	—	—	38.4	40.2	26.5	31	41.5	1
7205C	—	—	—	43.3	44.7	32	36	46.5	1
7206C	—	—	—	51.1	53	37.5	44	54.5	1
7207C	—	—	—	59.1	61.2	43.5	52	64	1
7208C	—	—	—	65.9	68.3	49	58	71.5	1
7209C	—	—	—	71.3	73.8	54.5	63	76.5	1
7210C	—	—	—	76.4	78.8	59.5	68	81	1.5
7211C	—	—	—	84.6	87.4	66	76	90	1.5
7212C	—	—	—	94.4	97.5	72	85	99.5	1.5
7213C	—	—	—	100.8	104.1	77.5	92	108.5	1.5
7214C	—	—	—	106.2	109.6	83	96	114	1.5
7215C	—	—	—	112.2	115.6	88.5	102	118	1.5
7216C	—	—	—	119.5	123.2	94	109	127	1.5
7217C	—	—	—	128	131.8	100	117	136	1.5
7218C	—	—	—	136.2	140.4	106	125	146	1.5
7219C	119.4	111.5	113.5	144.4	149	111.5	132	155	1.5
7220C	126.1	117.5	120	152.7	157.7	117.5	141	164	1.5
7221C	131.6	122.5	125	159.9	165.1	122.5	148	173.5	1.5
7222C	138.3	129	131	168.5	174.1	129	157	182	1.5
7224C	149.3	141	143	181.5	187.2	141	169	196	1.5
7226C	161.3	152.5	155	193	199.2	152.5	181	210	1.5
7028CT1B	162.9	153	157	183.5	187.4	153	172	197	1.5
7030CT1B	174.4	165	169	196.6	200.9	165	185	210	1.5
7032CT1B	185.7	175	180	209.8	214.2	175	198	225	1.5
7034CT1B	199.2	185	193	226	231.3	185	214	245	1.5
7036CT1B	212.2	197	206	242	248	197	230	263	1.5
7038CT1B	222.2	210	216	252	258	210	240	270	1.5
7040CT1B	235.2	220	229	268	275	220	255	290	1.5

(2) Cylindrical roller bearings

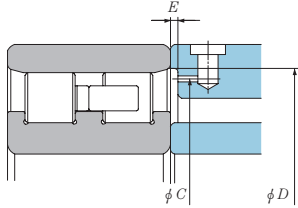


Fig. 7.6 NN30 and NN30T6 types

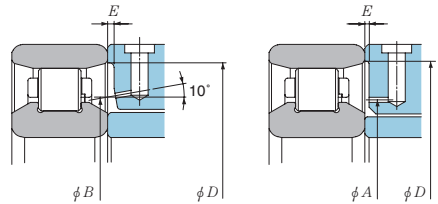


Fig. 7.7 N10HS type

Table 7.10

Bearing No.	C	Outer diameter of inner ring spacer	Inner diameter of outer ring spacer	D	E
NN3005	40.3	31	33.8	42	1
NN3006	47	38	40.5	50	1
NN3007	53.5	43	47.0	57	1
NN3008	59.5	48	53.0	63	1
NN3009	66	54	59.5	69	1
NN3010	71	59	64.5	74	1.5
NN3011	79	65	72.5	83	1.5
NN3012	84	70	77.5	88	1.5
NN3013	90 (89)	75	82.5	93	1.5
NN3014	98	82	90	102	1.5
NN3015	103	87	95	107	1.5
NN3016	111	93	103	115	1.5
NN3017	116	98	108	120	1.5
NN3018	125	105	117	130	1.5
NN3019	130	110	122	135	1.5
NN3020	135	115	127	140	1.5
NN3021	144 (143)	120	135	149	1.5
NN3022	153 (152)	127	144	158	1.5
NN3024	163 (162)	137	154	168	1.5
NN3026	179	150	171	185	1.5
NN3028	189	160	181	195	1.5
NN3030	202	172	194	210	1.5
NN3032	215.5	183	208	223	1.5
NN3034	232	196	224	240	1.5
NN3036	251	209	243	259	1.5
NN3038	261	219	253	269	1.5

Table 7.11

Bearing No.	A	B	Outer diameter of inner ring spacer	Inner diameter of outer ring spacer	D	E
N1006HS	—	40.4	37	38	50	1
N1007HS	—	46.5	42	43	57	1
N1008HS	—	51.7	47	48	63	1
N1009HS	—	57.7	52	53	69	1
N1010HS	—	62.7	57	58	74	1.5
N1011HS	—	69.7	63.5	64.5	83	1.5
N1012HS	—	74.8	68.5	69.5	88	1.5
N1013HS	—	79.7	73.5	74.5	93	1.5
N1014HS	86	—	78.5	80.5	102	1.5
N1015HS	91	—	83.5	85.5	107	1.5
N1016HS	97.5	—	88.5	90.5	115	1.5
N1017HS	102.5	—	93.5	95.5	120	1.5
N1018HS	110	—	102	104	130	1.5
N1019HS	115	—	107	109	135	1.5
N1020HS	120	—	112	114	140	1.5
N1021HS	125.9	—	118	120	149	1.5
N1022HS	133.1	—	123	125	158	1.5
N1024HS	143.3	—	133	135	168	1.5
N1026HS	157.2	—	143	145	185	1.5
N1028HS	167.2	—	153	155	195	1.5
N1030HS	179.6	—	165	167	210	1.5
N1032HS	191.1	—	175	177	223	1.5

NOTE) With certain products, the dimension C of L1 cage differs from that of T6 cage. The values in parentheses ( ) are dimensions C of L1 cages. Other dimensions of L1 cages are same as those of T6 cages.

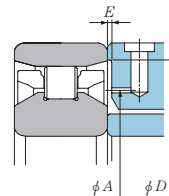


Fig. 7.8 N10HSR type

Table 7.12

Bearing No.	A	Outer diameter of inner ring spacer	Inner diameter of outer ring spacer	D	E
N1011 HSRT6	71.5	63.5	64.5	83	1.5
N1012 HSRT6	76.6	68.5	69.5	88	1.5
N1013 HSRT6	81.5	73.5	74.5	93	1.5
N1014 HSRT6	89.7	78.5	80.5	102	1.5
N1016 HSRT6	101.3	88.5	90.5	115	1.5
N1018 HSRT6	113.8	102	104	130	1.5
N1020 HSRT6	123.8	112	114	140	1.5

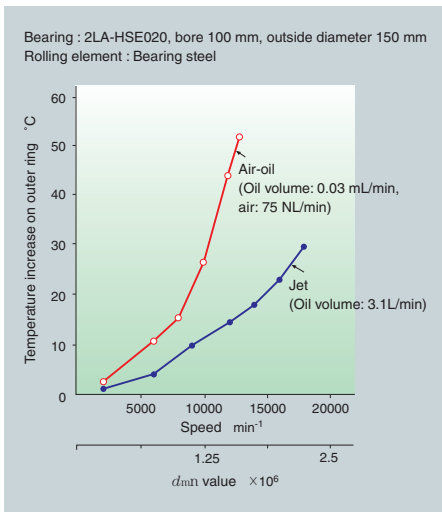
### ③ Jet lubrication

With this lubricating system, a high-speed jet of lubricant is injected into the bearing from the side. This is the most reliable lubricating technique and is typically used on the main spindle bearings of jet engines and gas turbines. It is currently capable of a  $d_{min}$  value of up to approximately  $4.0 \times 10^6$ .

When used as a lubricating system for the main spindle of a machine tool, it can minimize the temperature increase of the bearing. However, the

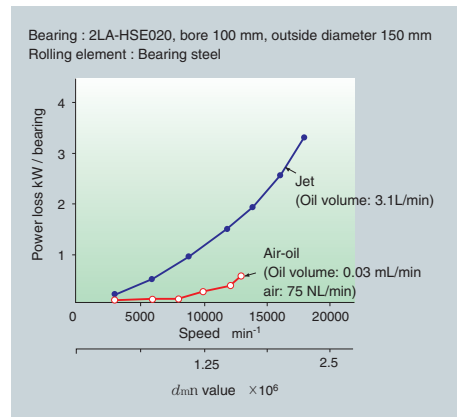
resultant torque loss is great, as a large amount of oil is supplied to each bearing. Therefore, this arrangement requires a powerful motor to drive the main spindle. Low viscosity oil ( $2-3 \text{ mm}^2/\text{s}$ ) is used.

Fig. 7.9 shows examples of the temperature increase with air-oil lubrication and jet lubrication, while Fig. 7.10 graphically plots test results of power loss.



**Fig. 7.9 Comparison of temperature increase of outer ring with air-oil lubrication and jet lubrication**

(The temperature increase with air-oil lubrication is relative to room temperature; the temperature with jet lubrication is relative to lubricant temperature.)



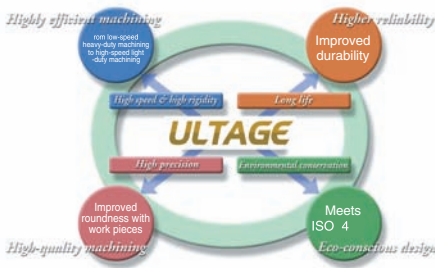
**Fig. 7.10 Comparison of power loss with air-oil lubrication and with jet lubrication**

## 8. New Technologies

### ① The new ULTAGE Series of super-high-speed precision bearings for machine tool main spindles

NTN has responded to need for improved efficiency, reliability, quality and environmental responsibility for machine tools by developing the ULTAGE Series of super-high-speed precision bearings. This new line of bearings demonstrates excellent performance thanks to the optimal internal design; a new approach to surface quality; and the use of special materials, special grease, and seals on both sides.

ULTAGE is the name for NTN's goal of achieving the ultimate performance with precision bearings, and expresses the "ULTIMATE" performance on any type of "STAGE."



#### ■ Concept

Our ideal is to offer a super high-speed precision bearing that offers excellent reliability while remaining eco-friendly.

#### 【 Design 】

The internal bearing design has been optimized to cope with varying applications and operating conditions in order to realize high speed and high rigidity, limited temperature increase, high precision, energy saving and low noise emission. It performs optimally in a variety of situations.

#### 【 Material 】

Adoption of special material and a special surface modification technique has resulted in greatly enhanced reliability.

#### 【 Lubrication 】

Use of unique eco-conscious technology and special grease contributes to decreased pollution and enhanced energy savings.

#### 【 Precision 】

Our super high-precision technology, in conjunction with our proven precision bearing technology, will help attain further improved precision.

### ② New material and new surface modification technology

The ULTAGE super high-speed precision bearing series for machine tool main spindles employs a special material that boasts excellent anti-seizure properties and wear resistance, as well as a unique surface modification technique.

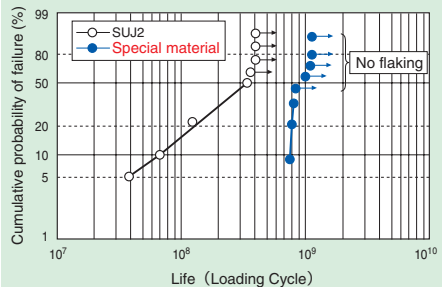
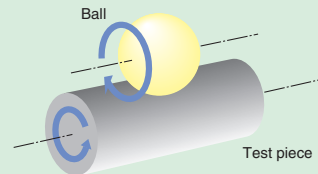
#### ■ Life under normal temperatures

The test results obtained from point contact test pieces under greater loading are graphically plotted in Fig. 8.1.

#### 【 Test conditions 】

Test piece	$\phi 12 \times 22$ mm cylindrical roller
Ball	$\phi 19.05$ (3/4")
Max. contact stress	5.88 GPa
Loading frequency	46,240 cycles/min
Lubricant	Turbine VG56 (oil bath)

#### 【 Schematic of test rig 】



Material	$L_{10}$ ( $\times 10^7$ cycles)	Life ratio
SUJ2	6.3	1
Special material	79.8	12.7

The rolling fatigue life of the special material is approximately 13 times as long as that of SUJ2.

Fig. 8.1 Life test results with point contact test pieces

**Life under high temperature**

The test results obtained from thrust-type test pieces at 200°C are graphically plotted in Fig. 8.2.

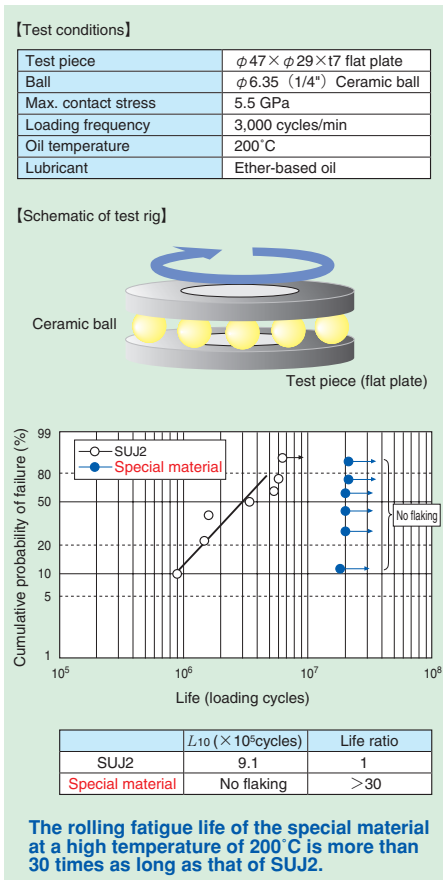


Fig. 8.2 High temperature life test results with thrust-type test pieces

**Improved wear resistance**

Test results with a Sawin type friction and wear test machine are illustrated in Fig. 8.3.

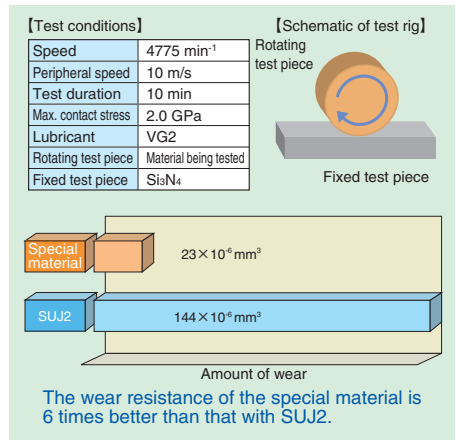


Fig. 8.3 Test results with Sawin type friction and wear test machine

**Improved anti-seizure property**

Test results with a two roller testing machine are illustrated in Fig. 8.4.

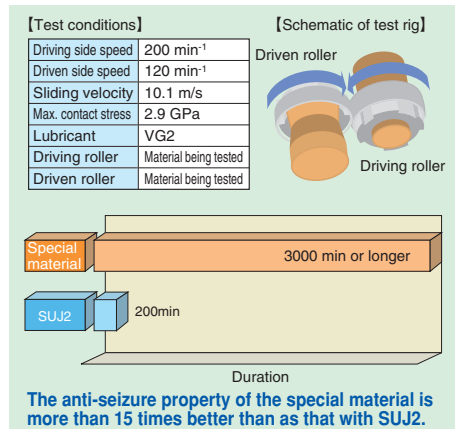


Fig. 8.4 Test results with a two roller testing machine

**Adoption of ceramic balls**

A comparison of temperature increase, which can vary depending on the material of rolling element, is illustrated in Fig. 8.5.

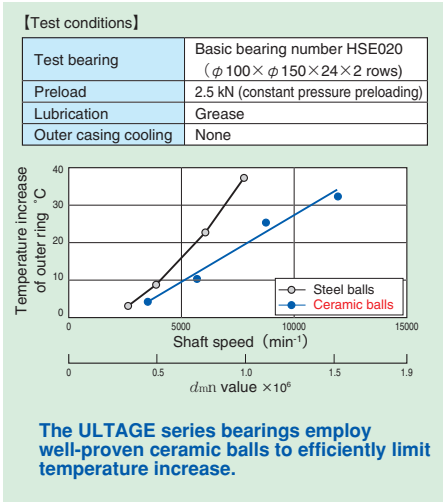


Fig. 8.5 Comparison of temperature increase with steel and ceramic rolling elements

**③ Environmentally conscious technology**

The eco-friendly ULTAGE Series is available in two specifications: an eco-friendly air-oil lubrication design that offers energy savings by reducing air and oil consumptions; and a grease-lubricated, sealed design that reduces environmental impact by employing a grease lubrication system that is capable of higher-speed operation.

**Required functions for the main spindle bearing**

Speed Rigidity Durability Precision Eco-friendly design

**For main spindles**  
Eco-friendly air-oil lubrication

HSL type

N10HSL type

**Reduced air/oil consumption contributes to energy savings.**

**Grease lubrication**

High-speed BNS LLB type

Sealed

Standard 70/79AD, CD LLB type

Sealed

N10HSRT6 type

**The introduction of a grease lubrication system that is capable of high-speed operation reduces the environmental impact.**

**For ball screw support**  
Grease lubrication

2A-BST LXL type

Sealed

**Combines durability with ease of handling.**

2A-BST type

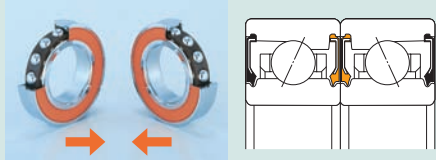
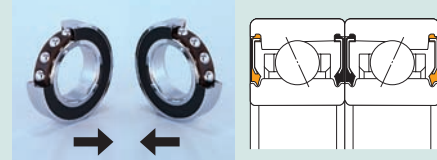
**Durability**

■ Grease-lubricated sealed angular contact ball bearings

(1) Ease of handling

ULTAGE angular contact ball bearings with seals are grease-prefilled bearings. No grease filling is necessary; you need only wipe off the rust-preventive oil before assembly. Seals of different colors are employed to differentiate the front and back. The black front face and orange back face are easily identified, which also makes it easy to orient the bearings in combinations (Table 8.1).

Table 8.1 Bearing combinations and seal colors

DB set (back-to-back)	DF set (face-to-face)
<div style="display: flex; justify-content: space-around; align-items: center;"> <div style="background-color: #ff8c00; padding: 2px 5px; border-radius: 5px;">Orange seal</div> <div>+</div> <div style="background-color: #ff8c00; padding: 2px 5px; border-radius: 5px;">Orange seal</div> </div> 	<div style="display: flex; justify-content: space-around; align-items: center;"> <div style="background-color: #333; color: white; padding: 2px 5px; border-radius: 5px;">Black seal</div> <div>+</div> <div style="background-color: #333; color: white; padding: 2px 5px; border-radius: 5px;">Black seal</div> </div> 

(2) Suggestions for simplified spindle structure

The ULTAGE Series sealed angular contact ball bearing makes possible high-speed operation with grease lubrication thanks to optimized internal design. Grease lubrication with minimal mist splash simplifies main spindle structure and contributes to lower environmental impact as well as cost reduction (Fig. 8.6).

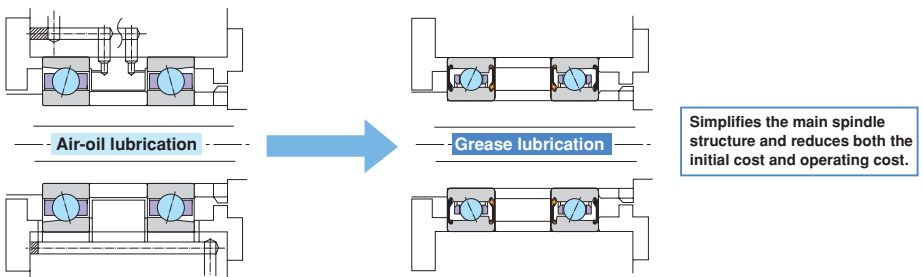


Fig. 8.6 Alteration to lubrication system (air-oil lubrication to grease lubrication)

**■Eco-friendly air-oil lubricated angular contact ball bearings and cylindrical roller bearings**

When combined with the eco-friendly nozzle, the eco-friendly air-oil lubricated angular contact ball bearing (HSL/HSFL Series) or cylindrical roller bearing (N10HSL[K] Series) can reduce the emissions of oil mist and noise.

**(1) Reduction of oil mist**

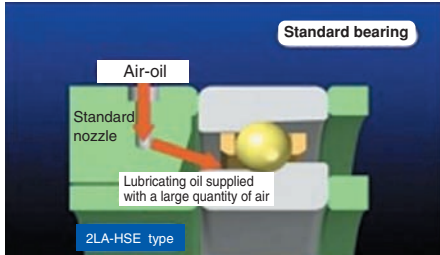
The eco-friendly air-oil lubricated bearing does not spray compressed air from the nozzle; instead, it uses the centrifugal force of the rotating inner ring to supply lubricating oil into the bearing. For this reason, this type of bearing conserves both air and oil. In addition, it reduces the amount of oil mist emitted from the

labyrinth seal of the spindle. The following photographs reveal the difference between the amount of oil mist emitted from the conventional standard bearing and that emitted from the eco-friendly bearing.

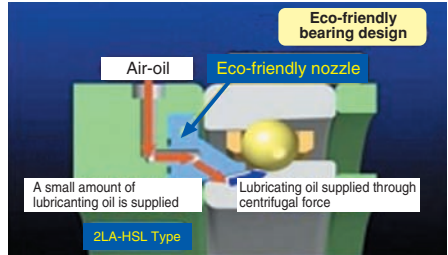
The lubricating oil discharged with air passes through the inside of the bearing and is then exhausted as a large volume of mist.

The lubricating oil exhausted from the bearing in the mist state is collected through the discharge port of the main spindle housing, but some of the oil mist leaks from the main spindle labyrinth seal and contaminates the immediate environment around the machine.

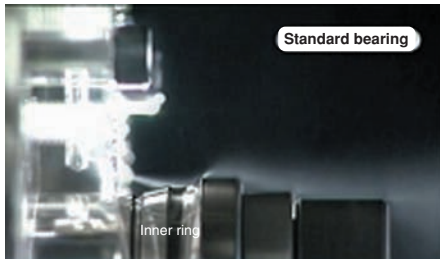
Adoption of the eco-friendly bearing therefore improves the working environment.



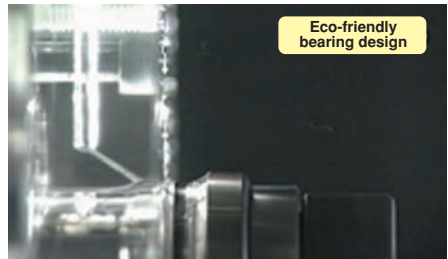
Conventional bearings consume a great deal of air when supplying lubricating oil to the bearing.



The eco-friendly type uses centrifugal force to supply lubricating oil into the bearing.



Atomized when emitted from the nozzle



The oil emitted from the nozzle is in a liquid state.



A large amount of oil mist passes through the bearing, contaminating the working environment.



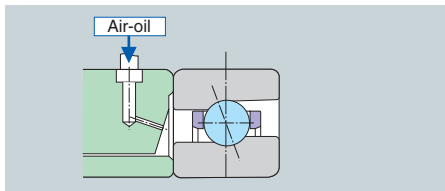
The amount of oil mist is reduced, minimizing environmental contamination in work areas.



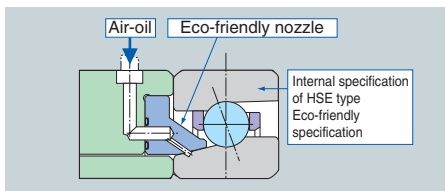
**(2) Noise Reduction**

The standard air-oil lubrication method uses air to supply a slight amount of oil. It also uses a special nozzle spacer, as shown in **Figs. 8.7 and 8.9**.

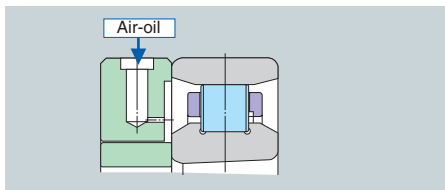
In addition, this method uses a nozzle measuring 1 to 1.5 mm in diameter to supply oil to the raceway surface of the bearing at the rate of 30 to 40 NL/min/bearing. To supply this oil, the nozzle emits compressed air as a jet to break the air barrier of the bearing, which is created when running at high speed. In this way, the air is used as a tool for supplying oil. The eco-friendly bearing developed by NTN reduces the amount of air consumed, thus reducing the whistling noise of the flowing air. The mechanism used in this type of bearing is as follows: the centrifugal force of the bearing inner ring feeds a small amount of oil from the nozzle to the raceway surface of the bearing along the tapered surface. (**Figs. 8.8 and 8.10**).



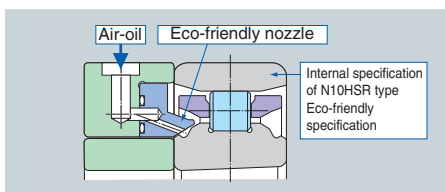
**Fig. 8.7 Standard nozzle**



**Fig. 8.8 Eco-friendly type nozzle**



**Fig. 8.9 Current bearing N10HS type**



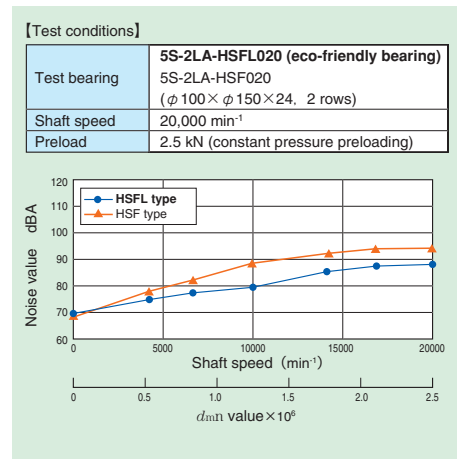
**Fig. 8.10 ULTAGE N10HSL type**

Since the function of the compressed air is only to deliver lubricating oil to the cavity of the inner ring, a large quantity of air is not required. In addition, since the air used to supply the oil is released between the tapered surfaces, the whistling noise of air is also reduced.

When the eco-friendly bearing is employed, the noise is reduced by 6 to 8 dBA.

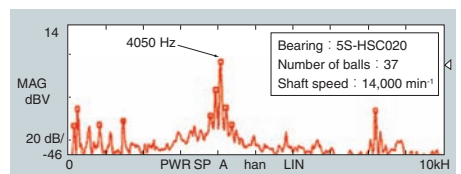
Example:

In the high-speed region in excess of 10,000 min<sup>-1</sup>, noise is reduced by 6 to 8 dBA (**Fig. 8.11**).



**Fig. 8.11 Comparison of noise values**

The eco-friendly bearing is particularly good for reducing "screeching" noise. The high-frequency component of the noise generated at high speeds is well attenuated. The reason for this is as follows: when the air jet emitted from the standard nozzle hits the rolling elements, a high-pitched noise is generated; in contrast, the eco-friendly nozzle does not emit air on the rolling elements, which reduces screeching noise.



**Fig. 8.12 Frequency characteristics of bearing noise (standard nozzle)**





## Main Spindle Bearings

### 9. Angular Contact Ball Bearings for Radial Loads CONTENTS

<b>9. Angular Contact Ball Bearings for Radial Loads</b> .....	56~207
① Features of various types .....	56
② Standard cage design .....	58
③ Bearing designations .....	58
④ Bearing accuracy .....	60
⑤ Internal clearance and standard preload of duplex angular contact ball bearings .....	62
⑥ Recommended fit for angular contact ball bearings .....	68
⑦ Duplex angular contact ball bearings .....	68
⑧ Duplex arrangement codes of duplex angular contact ball bearings .....	69
⑨ Flush grinding and universal matching .....	69
⑩ Angular contact ball bearings with ceramic balls .....	70
⑪ Operating life of bearings with ceramic balls .....	71
⑫ Recommended lubrication specifications .....	72
⑬ Standard angular contact ball bearings	
79U and 70U types .....	73
⑭ High-speed angular contact ball bearings	
HSE type .....	74
⑮ Super high-speed angular contact ball bearings	
HSF type .....	75
⑯ Eco-friendly air-oil lubricated angular contact ball bearings	
HSL type HSFL type .....	76
⑰ Air-oil lubricated high-speed angular ball bearings with re-lubricating hole on the outer ring - HSEW Type .....	78
⑱ Grease-lubricated sealed standard angular contact ball bearings	
79LLB/70LLB types, 5S-79LLB/70LLB types .....	80
⑲ Grease-lubricated sealed angular contact ball bearings	
BNS type 5S-BNS type .....	82
⑳ Dimension table	
Standard angular contact ball bearing .....	84
High-speed angular contact ball bearings .....	112
Super high-speed angular contact ball bearings .....	136
Eco-friendly high-speed angular contact ball bearings .....	138
Eco-friendly super high-speed angular contact ball bearings .....	146
Air-oil lubricated high-speed angular ball bearings with re-lubricating hole on the outer ring-HSEW Type .....	148
Grease-lubricated sealed standard angular contact ball bearings .....	156
Grease-lubricated sealed high-speed angular contact ball bearings .....	172
Angular contact ball bearings for motors and lathes .....	196

## 9. Angular Contact Ball Bearings for Radial Loads

Angular contact ball bearings for radial loads used in machine tools are bearings which inner and outer rings cannot be separated. This type of bearing includes series 78, 79U, 70U, 72, HSE9, HSE0, BNS9, BNS0, BNT9, BNT0 and BNT2. For angular contact ball bearings, an imaginary straight line connecting the contact points between the balls and inner and outer rings forms an angle with the radial axis. The optimal contact angle can be selected to meet functional requirements such as high speed or high rigidity. The available contact angles are 15° (contact angle symbol "C"), 20° (no symbol), 25° ("AD"), and 30° (no symbol). (Fig. 9.1)

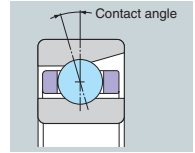


Fig. 9.1 Contact angle

### ① Features of various types

#### Open bearings

##### ■ Standard angular contact ball bearings (78, 79, 70 and 72 Types)

Standard angular contact ball bearings are available in four types: 78, 79, 70 and 72. Types 79 and 70 include the 79U and 70U ULTAGE Series, which accommodate high speed and low temperature rise with optimized specifications of the internal design. For these types, three contact angles are available: 15° (contact angle symbol "C"), 25° ("AD"), and 30° (no symbol). The contact angle of 25°, however, is also available with 79U and 70U types. This bearing series has an accuracy of JIS class 5 or better. The features include high speed, high rigidity, and high load capacity. Some models incorporate ceramic balls.

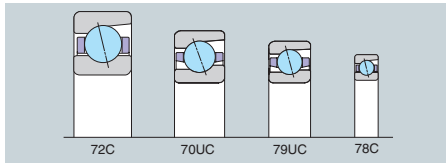


Fig. 9.2. Standard angular contact ball bearings

##### ■ High-speed angular contact ball bearings (HSE type)

High-speed angular contact bearings are available in two types: HSE9 and HSE0. The boundary dimensions of this bearing series are determined according to the JIS dimension series (9, 0), and three types of contact angles are available: 15° (contact angle symbol "C"), 20° (no symbol), and 25° ("D"). The accuracy of this ball bearing series is JIS class 5 or better, and the ball diameter is smaller than that of the standard angular contact ball bearing in order to accommodate high speeds. The outer

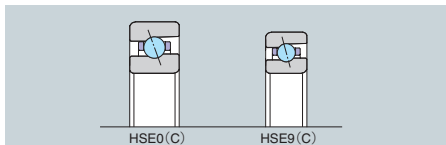


Fig. 9.3 High-speed angular contact ball bearings

surface of the inner ring and the bore of the outer ring are relieved on one side, and this bearing series employs an air-oil lubrication system to ensure smooth oil flow. In addition, it employs special materials, and its surface is modified to protect the bearing from wear and seizure more positively. The HSE type bearing is available with either steel balls or ceramic balls.

##### ■ Ultra-high-speed angular ceramic ball bearings (HSF type)

The HSF0 type ultra-high-speed angular contact ceramic ball bearing employs smaller balls than the HSE0C type to ensure rigidity and prevent temperature rise. In addition, it employs a contact angle of 25° to accommodate the reduction in contact angle caused by centrifugal force during operation.

These features allow the use of an air-oil lubrication system ( $d_{min}$  value  $< 2.6 \times 10^6$ ) in a speed region that was previously possible only with a conventional jet lubrication system.

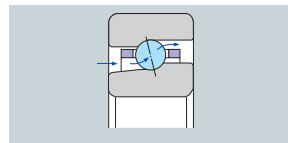


Fig. 9.4 Ultra-high-speed angular contact ball bearings

##### ■ Eco-friendly air-oil lubricated angular ball bearings (HSL and HSFL types)

For eco-friendly air-oil lubricated angular contact ball bearings (HSL and HSFL types), the angle of the inner ring outer surface (counterbore area) is optimized compared with that of HSE and HSF types. In addition, these angular contact ball bearings are dedicated to air-oil lubrication by adopting a circumferential groove and an eco-friendly nozzle. They accommodate the same high speed as HSE and HSF types while being more eco-friendly. They generate less noise and conserve energy since they consume less air and oil. The

accuracies of these bearing types are JIS class 5 or better. For the HSL type, three contact angles [20° (no symbol), and 25° ("AD")] are available. For the HSFL type, however, only one contact angle (25°) is available. The HSFL type utilizes a specially designed eco-friendly nozzle.

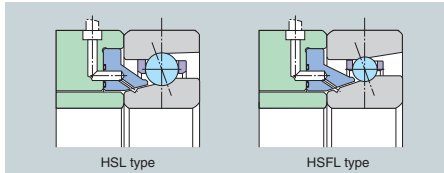


Fig. 9.5 Eco-friendly angular contact ball bearings

**Air-oil lubricated high-speed angular ball bearings with re-lubricating hole on the outer ring (HSEW type)**

HSEW type is designed based on HSE type as high speed angular contact ball bearing for air-oil lubrication with lubrication hole on outer ring.

Spacers next to these bearings don't need length for nozzle to be mounted, and can be short. These short spacers have an effect on compact design and rigidity of spindle as a result of shortened distance between bearing and tool.

In addition, direct air-oil supply through the hole on outer ring achieves improved lubricating reliability with low air flow rate and small oil consumption.

JIS Class 5 or higher bearing accuracy is applied on this type. Two kind of contact angles are available, 20° (no suffix) and 25° (AD).

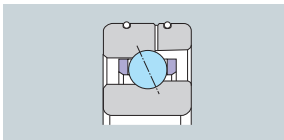


Fig. 9.6 Ultra-high-speed angular contact ball bearings

**High-speed angular contact ball bearings for grinding machines/motors (BNT type)**

The boundary dimensions of high-speed angular ball bearings for grinding machines/motors (BNT type) are determined according to the JIS dimension series (9, 0, 2). For this bearing type, only one contact angle (15°, no symbol) is available, and the bearing accuracies are JIS class 5 or better. This bearing uses mainly air-oil

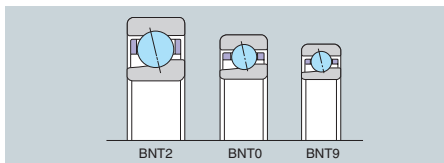


Fig. 9.7 High-speed angular contact ball bearings for grinding machines/motors

lubrication and oil mist lubrication. The features of this bearing are high speed capability and high load capacity. This type of bearing is available with either steel balls or ceramic balls.

**Sealed bearings**

**Standard grease-lubricated sealed angular contact ball bearings (79LLB/70LLB types)**

The standard grease-lubricated sealed angular contact ball bearings are available in 79 and 70 series. Non-contact rubber seals are mounted on both sides and special grease is used. As a result, these bearings accommodate high speed, offer prolonged service life, and help to maintain a comfortable working environment. These bearings are available in contact angles of 15° (contact angle symbol "CD") and 25° ("AD") and with a special accuracy of P42 (JIS class 4 dimensional accuracy and JIS class 2 running accuracy). Since they are pre-filled with grease, these bearings require no cleaning before use and are therefore easy to handle. They are available with either steel balls or ceramic balls.

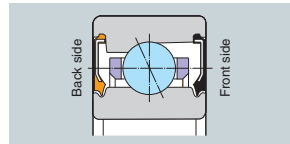


Fig. 9.8 Standard grease-lubricated sealed angular contact ball bearings

**High-speed grease-lubricated sealed angular contact ball bearings (BNS type)**

High-speed grease-lubricated sealed angular contact ball bearings (BNS type) are available with the boundary dimensions of HSE type. Non-contact rubber seals are incorporated on both sides and its inner structure is optimized. It is also pre-filled with a special grease to achieve high speed capability, inhibit temperature rise, extend service life and create a comfortable working environment. This bearing type is available in contact angles of 15° (contact angle symbol "CD"), 20° (no symbol), and 25° ("AD"). Bearing accuracy is JIS class 4 or better. The bearing ring is made of a special material, and the surface is modified to protect the bearing from wear and seizure. Since this type is pre-filled with grease, it requires no cleaning before use and is therefore easy to handle. It is available with either steel balls or ceramic balls.

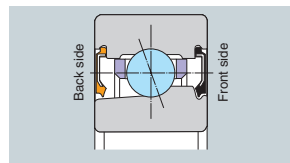


Fig. 9.9 High-speed grease-lubricated sealed angular contact ball bearings

② Standard cage design

Table 9.1 Standard cages of angular contact ball bearings for radial loads

Bearing series	Molded nylon cage	Machined phenol resin cage	Machined high tensile brass cage
78C	—	7805C ~ 7824C	7826C ~ 7834C
79U (15°, 25°, 30°), 79C	7900U ~ 7926U	—	7928C ~ 7934C
70U (15°, 25°, 30°), 70C	7000U ~ 7028U	—	7028C ~ 7040C
72C	7200C ~ 7220C	7221C ~ 7228C	—
HSE9U (15°, 20°, 25°)	—	HSE910U ~ HSE934U	—
HSE0 (15°, 20°, 25°)	—	HSE010 ~ HSE034	—
HSF	—	HSF010 ~ HSF020	—
HSL9U (20°, 25°)	—	HSL910U ~ HSL926U	—
HSL0 (20°, 25°)	—	HSL010 ~ HSL026	—
HSFL0	—	HSFL010 ~ HSFL020	—
HSEW9U (20°, 25°)	—	HSEW910U ~ HSEW920U	—
HSEW0 (20°, 25°)	—	HSEW010 ~ HSEW020	—
79 LLB (15°, 25°)	7900 LLB ~ 7910 LLB	—	—
70 LLB (15°, 25°)	7000 LLB ~ 7010 LLB	—	—
BNS9 LLB (15°, 20°, 25°)	—	BNS910 LLB ~ BNS920 LLB	—
BNS0 LLB (15°, 20°, 25°)	—	BNS010 LLB ~ BNS020 LLB	—
BNT9	—	BNT900 ~ BNT913	—
BNT0	—	BNT000 ~ BNT014	—
BNT2	—	BNT200 ~ BNT216	—

Note 1) Cage design is subject to change without notice. For detailed information, contact NTN Engineering.

Note 2) The polyamide plastic cage can be used up to the following rotating speeds depending on the material of the rolling element.

The  $d_{min}$  value  $0.9 \times 10^6$  for bearing steel and  $d_{min}$  value  $1.0 \times 10^6$  for ceramics. Machined phenol resin cages must be used if the allowable rotational speed of the dimensions listed exceeds the figures above. For detailed information, contact NTN Engineering.

③ Bearing designations

78, 79, 70, 72, BNT type

5S- 7 0 20 U C T1 DB /GL P4

**Precision class**

P5: JIS class 5, P4: JIS class 4, P2: JIS class 2

**Internal clearance code**

GL: Light preload, GN: Normal preload, GM: central preload, Gxx: Special preload, CSxx: Special clearance

**Matching code**

DB: Back-to-back (double-row)  
 DT: Tandem (double-row)  
 DTBT: Tandem back-to-back (quad-row)

**Cage code**

No code: Standard cage  
 T1: Machined phenol resin cage  
 T2: Molded polyamide resin cage  
 L1: Machined high tensile brass cage

**Contact angle code**

C: 15°, AD: 25°, No symbol: 20°

**Bearing series (ULTAGE Series)**

Bore diameter code (See dimension table)

**Dimension series code**

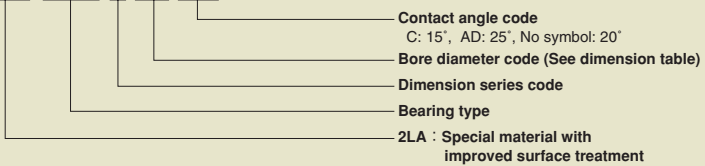
**Bearing type**

**Material code**

5S: Ceramic rolling elements  
 No code: Steel rolling elements

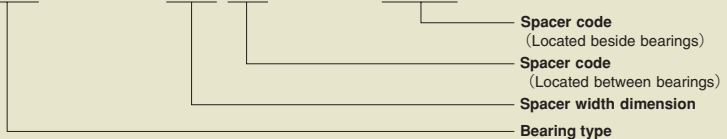
**HSE type**

**5S- 2LA-HSE 0 20 AD T2 DB /GL P4**



**HSL type**

**5S- 2LA-HSL 0 20 DB +xx Dn /GL P4 +TKZ**



(notes) HSL : Bearing series code

xxDn : Eco-friendly nozzle, or Spacer with Eco- friendly nozzle located between bearings

TKZ : Eco-friendly nozzle, or Spacer with Eco- friendly nozzle located beside bearings

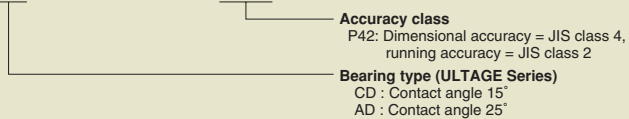
**HSEW type**

**5S- 2LA-HSEW 0 20 DB/GL P4**



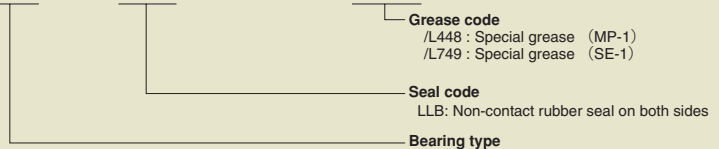
**79LLB / 70LLB type**

**5S- 7006 CD LLB DB /GL P42 /L749**



**BNS type**

**5S- 2LA-BNS 0 20 LLB DB /GL P4 /L749**



④ Bearing accuracy

Table 9.2 Inner rings

Nominal bore diameter $d$		Single plane mean bore diameter deviation $d_{mp}$						Single radial plane bore diameter variation $V_{dsp}$						Mean bore diameter deviation $V_{dmp}$			Inner ring radial runout $K_{ia}$		
mm		Class 5		Class 4 <sup>①</sup>		Class 2 <sup>②</sup>		Diameter series 9			Diameter series 0, 2			Class 5	Class 4	Class 2	Class 5	Class 4	Class 2
over	incl.	high	low	high	low	high	low	Class 5 max	Class 4	Class 2	Class 5 max	Class 4	Class 2	max			max		
2.5	10	0	-5	0	-4	0	-2.5	5	4	2.5	4	3	2.5	3	2	1.5	4	2.5	1.5
10	18	0	-5	0	-4	0	-2.5	5	4	2.5	4	3	2.5	3	2	1.5	4	2.5	1.5
18	30	0	-6	0	-5	0	-2.5	6	5	2.5	5	4	2.5	3	2.5	1.5	4	3	2.5
30	50	0	-8	0	-6	0	-2.5	8	6	2.5	6	5	2.5	4	3	1.5	5	4	2.5
50	80	0	-9	0	-7	0	-4	9	7	4	7	5	4	5	3.5	2	5	4	2.5
80	120	0	-10	0	-8	0	-5	10	8	5	8	6	5	5	4	2.5	6	5	2.5
120	150	0	-13	0	-10	0	-7	13	10	7	10	8	7	7	5	3.5	8	6	2.5
150	180	0	-13	0	-10	0	-7	13	10	7	10	8	7	7	5	3.5	8	6	5
180	250	0	-15	0	-12	0	-8	15	12	8	12	9	8	8	6	4	10	8	5

- ① The tolerance of bore diameter deviation  $d_{s_1}$ , applicable to classes 4 and 2, is the same as the tolerance of mean bore diameter deviation  $d_{mp}$ . This applies to the diameter series 0 or 2 for class 4, and all the diameter series for class 2.
- ② Applicable to individual bearing rings manufactured for duplex bearings.

Table 9.3 Outer rings

Nominal outside diameter $D$		Single plane mean outside diameter deviation $D_{mp}$						Single radial plane outside diameter variation $V_{Dsp}$						Mean single plane outside diameter variation $V_{Dmp}$			Outer ring radial runout $K_{ea}$		
mm		Class 5		Class 4 <sup>③</sup>		Class 2 <sup>③</sup>		Diameter series 9			Diameter series 0, 2			Class 5	Class 4	Class 2	Class 5	Class 4	Class 2
over	incl.	high	low	high	low	high	low	Class 5 max	Class 4	Class 2	Class 5 max	Class 4	Class 2	max			max		
18	30	0	-6	0	-5	0	-4	6	5	4	5	4	4	3	2.5	2	6	4	2.5
30	50	0	-7	0	-6	0	-4	7	6	4	5	5	4	4	3	2	7	5	2.5
50	80	0	-9	0	-7	0	-4	9	7	4	7	5	4	5	3.5	2	8	5	4
80	120	0	-10	0	-8	0	-5	10	8	5	8	6	5	5	4	2.5	10	6	5
120	150	0	-11	0	-9	0	-5	11	9	5	8	7	5	6	5	2.5	11	7	5
150	180	0	-13	0	-10	0	-7	13	10	7	10	8	7	7	5	3.5	13	8	5
180	250	0	-15	0	-11	0	-8	15	11	8	11	8	8	8	6	4	15	10	7
250	315	0	-18	0	-13	0	-8	18	13	8	14	10	8	9	7	4	18	11	7

- ③ The tolerance of outside diameter deviation  $D_{s_1}$ , applicable to classes 4 and 2, is the same as the tolerance of mean outside diameter deviation  $D_{mp}$ . This applies to the diameter series 0 or 2 for class 4, and all the diameter series for class 2.



Unit:  $\mu\text{m}$

Perpendicularity of inner ring face with respect to the bore $S_{ia}$			Axial runout $S_{ia}$			Width deviation						Width variation		
						$B_s$				$VB_s$				
Class 5	Class 4	Class 2	Class 5	Class 4	Class 2	Single bearing		Duplex bearing		Class 5	Class 4	Class 2		
						Class 5	Class 4	Class 2	Class 5				Class 4	high
7	3	1.5	7	3	1.5	0	-40	0	-40	0	-250	5	2.5	1.5
7	3	1.5	7	3	1.5	0	-80	0	-80	0	-250	5	2.5	1.5
8	4	1.5	8	4	2.5	0	-120	0	-120	0	-250	5	2.5	1.5
8	4	1.5	8	4	2.5	0	-120	0	-120	0	-250	5	3	1.5
8	5	1.5	8	5	2.5	0	-150	0	-150	0	-250	6	4	1.5
9	5	2.5	9	5	2.5	0	-200	0	-200	0	-380	7	4	2.5
10	6	2.5	10	7	2.5	0	-250	0	-250	0	-380	8	5	2.5
10	6	4	10	7	5	0	-250	0	-250	0	-380	8	5	4
11	7	5	13	8	5	0	-300	0	-300	0	-500	10	6	5

Unit:  $\mu\text{m}$

Perpendicularity of outer ring outside surface with respect to the face $S_{D}$			Axial runout $S_{ea}$			Width deviation		Width variation		
						$C_s$		$VC_s$		
Class 5	Class 4	Class 2	Class 5	Class 4	Class 2	All types		Class 5	Class 4	Class 2
						Class 5	Class 4			
8	4	1.5	8	5	2.5	Identical to of $B_s$ relative to $d$ of the same bearing.	5	2.5	1.5	
8	4	1.5	8	5	2.5		5	2.5	1.5	
8	4	1.5	10	5	4		6	3	1.5	
9	5	2.5	11	6	5		8	4	2.5	
10	5	2.5	13	7	5		8	5	2.5	
10	5	2.5	14	8	5		8	5	2.5	
11	7	4	15	10	7		10	7	4	
13	8	5	18	10	7		11	7	5	

5 Internal clearance and standard preload of duplex angular contact ball bearings

The initial internal clearance or preload for duplex angular contact ball bearings is determined with consideration for two factors: temperature rise during operation and the rigidity and accuracy required after assembly or during operation.

The internal clearance of the bearing may be significantly affected during operation due to three factors: the reduction in clearance caused by fits, the temperature difference between the inner and outer rings during operation, and the effects of centrifugal force. Depending on the initial internal clearance, a significantly reduced clearance may result in extreme temperature rise, vibration, noise, and short service life. In addition, seizure may result in some cases. For this reason, it is important to determine the optimal initial internal clearance and initial preload required for operation. When using a duplex angular contact ball bearing on the main spindle of a machine tool, the preload is determined by considering the type, main spindle configuration, lubrication system, drive system, intended functions, and other factors. However, preload can also be generalized by the  $d_{m1}$  value ( $d_{m1}$ : pitch circle diameter across rolling elements [mm] multiplied by speed [min<sup>-1</sup>]), as shown below:

$$d_{m1} \leq 0.5 \times 10^6 \dots\dots\dots \text{Normal preload (GN)}$$

$$0.5 \times 10^6 < d_{m1} \leq 0.65 \times 10^6 \dots \text{Light preload (GL)}$$

$$d_{m1} > 0.65 \times 10^6 \dots\dots\dots 0 \text{ to positive clearance}$$

For detailed information, contact NTN Engineering.

Table 9.4 Radial internal clearance of duplex angular contact ball bearings

Unit:  $\mu\text{m}$

Nominal bore diameter $d$ mm		C1		C2		CN (normal)	
over	incl.	min	max	min	max	min	max
—	10	3	8	6	12	8	15
10	18	3	8	6	12	8	15
18	30	3	10	6	12	10	20
30	50	3	10	8	14	14	25
50	80	3	11	11	17	17	32
80	100	3	13	13	22	22	40
100	120	3	15	15	30	30	50
120	150	3	16	16	33	35	55
150	180	3	18	18	35	35	60
180	200	3	20	20	40	40	65

For duplex angular contact ball bearings, NTN recommends the initial radial clearances and standard preloads shown in Tables 9.4 through 9.21. Select the optimal radial internal clearance and initial preload for your application. When ordering a duplex angular ball bearing, please specify the desired preload and clearance. If these are not specified in the order, we will ship a bearing with standard clearance. However, some product types do not have a standard clearance. In this case, we will inform you of the available clearances.

Standard preloads of angular contact ball bearings (DB and DF arrangements)

Table 9.5 Standard angular contact ball bearings (78C type)

Unit: N

Nominal bore diameter $d$ (mm)	Contact angle: 15°		
	78xxC		
	Light preload (GL)	Normal preload (GN)	Medium preload (GM)
25	10	29	78
30	10	29	78
35	10	29	78
40	10	29	78
45	20	49	98
50	20	49	98
55	29	98	196
60	29	98	196
65	29	98	196
70	29	98	196
75	29	98	196
80	29	98	196
85	49	147	294
90	49	147	294
95	49	147	294
100	49	147	294
105	49	147	294
110	78	196	490
120	78	196	490
130	98	294	590
140	98	294	590
150	147	390	785
160	147	390	785
170	147	490	980

Table 9.6 Standard angular contact ball bearings (79 series)

Unit: N

Nominal bore diameter <i>d</i> (mm)	Contact angle: 15°			Contact angle: 25°			Contact angle: 30°		
	79xxUC/5S-79xxUC			79xxUAD/5S-79xxUAD			79xxUJ/5S-79xxU		
	Light preload (GL)	Normal preload (GN)	Medium preload (GM)	Light preload (GL)	Normal preload (GN)	Medium preload (GM)	Light preload (GL)	Normal preload (GN)	Medium preload (GM)
10	—	20	39	—	29	59	—	39	78
12	—	20	39	—	29	69	—	39	78
15	—	29	59	—	49	98	20	59	118
17	—	29	69	20	49	98	20	69	127
20	20	49	88	20	69	147	29	88	186
25	20	49	98	20	78	157	29	98	196
30	20	49	108	20	78	167	29	98	206
35	29	78	167	39	127	255	49	167	325
40	29	88	177	39	137	275	49	167	345
45	39	108	216	49	167	345	69	216	420
50	39	118	226	49	177	355	69	226	450
55	39	118	236	59	186	375	69	235	460
60	39	127	245	59	196	380	78	245	480
65	39	127	245	59	196	390	78	245	490
70	59	177	365	88	284	560	108	355	695
75	59	177	365	88	284	570	108	355	705
80	59	186	365	88	284	580	108	365	715
85	78	245	490	118	390	770	147	480	970
90	88	255	500	118	390	780	147	490	980
95	88	255	510	118	400	795	157	500	990
100	108	325	655	157	510	1 020	196	635	1 270
105	108	335	655	157	520	1 040	196	645	1 300
110	108	335	665	157	530	1 060	206	655	1 310
120	137	410	835	196	655	1 300	245	815	1 620
130	167	510	1 020	235	800	1 600	305	990	1 990
	79xxC								
140	196	490	980						
150	245	685	1 470						
160	245	685	1 470						
170	245	685	1 470						

**Table 9.7 Standard angular contact ball bearings (70 series)**

d (mm)	15			25			30		
	70		5 70	70		5 70	70		5 70
10	—	29	59	20	49	108	20	69	127
12	—	39	69	20	59	108	20	69	137
15	—	39	78	20	59	127	29	78	157
17	20	49	98	20	78	157	29	98	196
20	20	69	137	29	108	216	39	137	265
25	29	78	147	39	118	235	49	147	294
30	29	98	186	49	147	305	59	186	375
35	39	118	235	59	186	380	69	235	480
40	39	127	255	59	206	400	78	255	510
45	49	147	305	69	245	480	88	305	600
50	49	157	325	78	255	510	98	325	635
55	69	216	420	98	335	665	127	420	845
60	69	216	430	108	345	685	127	430	855
65	78	226	460	108	365	725	137	450	900
70	98	294	580	137	460	920	177	580	1 150
75	98	294	600	137	470	940	177	590	1 180
80	118	365	725	177	580	1 150	216	715	1 430
85	127	375	750	177	590	1 180	226	735	1 470
90	147	440	890	206	705	1 400	265	875	1 750
95	157	460	910	216	715	1 430	275	900	1 790
100	157	460	930	226	740	1 470	284	920	1 830
105	186	550	1 090	255	860	1 720	335	1 070	2 140
110	206	630	1 250	294	990	1 980	380	1 230	2 460
120	216	635	1 270	305	1 010	2 020	380	1 260	2 510
130	265	800	1 600	380	1 270	2 530	480	1 570	3 150
140	275	815	1 630	380	1 280	2 570	490	1 600	3 200

70xxC			
150	294	785	1 960
160	490	980	2 450
170	490	980	2 450
180	490	980	2 450
190	590	1 470	3 450
200	590	1 470	3 450

**Table 9.8 Standard angular contact ball bearings (72C series)**

Unit: N

Nominal bore diameter d (mm)	Contact angle: 15°		
	72xxC		
	Light preload (GL)	Normal preload (GN)	Medium preload (GM)
10	20	49	98
12	20	49	98
15	20	49	147
17	20	49	147
20	49	98	294
25	49	98	294
30	49	98	294
35	78	196	490
40	78	196	490
45	98	294	590
50	98	294	590
55	147	390	785
60	147	390	785
65	147	390	785
70	196	490	980
75	196	490	980
80	196	490	980
85	294	685	1 470
90	294	685	1 470
95	294	685	1 960
100	294	685	1 960
105	390	980	2 450
110	390	980	2 450
120	390	980	2 450
130	490	1 470	2 940

**Table 9.9 High-speed angular contact ball bearings (HSE9 series)**

Unit: N

Nominal bore diameter <i>d</i> (mm)	Contact angle: 15°			Contact angle: 20°			Contact angle: 25°		
	HSE9xxUC/5S-HSE9xxUC			HSE9xxU/5S-HSE9xxU			HSE9xxUAD/5S-HSE9xxUAD		
	Light preload (GL)	Normal preload (GN)	Medium preload (GM)	Light preload (GL)	Normal preload (GN)	Medium preload (GM)	Light preload (GL)	Normal preload (GN)	Medium preload (GM)
50	34	88	177	39	127	255	39	177	345
55	44	108	216	49	157	345	49	216	440
60	44	118	226	49	167	345	54	226	440
65	44	118	226	49	167	345	54	226	440
70	69	167	345	74	245	490	78	345	685
75	69	177	345	74	255	490	83	345	685
80	69	177	345	74	255	540	83	345	685
85	98	235	490	98	345	685	108	490	930
90	98	245	490	108	345	735	118	490	980
95	98	255	490	108	345	735	118	490	980
100	118	294	590	127	440	835	137	590	1170
105	118	294	590	127	440	885	137	590	1170
110	118	294	590	127	440	885	137	590	1170
120	157	390	785	167	540	1080	177	785	1570
130	186	490	930	196	685	1370	226	930	1860
140	186	490	930	206	685	1370	226	930	1860
150	255	635	1270	276	930	1860	294	1270	2550
160	255	635	1270	276	930	1860	294	1270	2550
170	255	635	1270	276	930	1860	294	1270	2550

**Table 9.10 High-speed angular contact ball bearings (HSE0 series)**

Unit: N

Nominal bore diameter <i>d</i> (mm)	Contact angle: 15°			Contact angle: 20°			Contact angle: 25°		
	HSE0xxC/5S-HSE0xxC			HSE0xx/5S-HSE0xx			HSE0xxAD/5S-HSE0xxAD		
	Light preload (GL)	Normal preload (GN)	Medium preload (GM)	Light preload (GL)	Normal preload (GN)	Medium preload (GM)	Light preload (GL)	Normal preload (GN)	Medium preload (GM)
50	59	157	315	69	235	460	78	305	600
55	69	177	345	78	255	510	78	325	645
60	69	186	365	78	265	530	88	345	685
65	69	186	365	78	265	540	88	345	695
70	88	226	450	98	325	655	108	420	845
75	98	235	480	108	355	695	118	450	900
80	108	275	550	118	400	805	127	520	1 030
85	108	275	560	118	400	815	127	520	1 040
90	127	325	645	137	470	940	157	610	1 220
95	127	325	645	147	480	960	157	620	1 240
100	137	345	675	147	490	990	157	635	1 270
105	157	390	775	167	570	1 140	186	725	1 450
110	196	480	960	206	695	1 400	226	900	1 800
120	196	480	960	216	705	1 410	226	910	1 820
130	275	695	1 380	305	1 020	2 030	325	1 300	2 610
140	284	715	1 430	315	1 050	2 090	345	1 350	2 710
150	294	735	1 470	325	1 080	2 150	345	1 380	2 770
160	345	865	1 730	375	1 260	2 520	410	1 630	3 250
170	390	990	1 980	430	1 450	2 900	470	1 860	3 750

**Table 9.11 Eco-friendly air-oil lubricated angular contact ball bearings (HSL9 series)**

Unit: N

Nominal bore diameter $d$ (mm)	Contact angle: 20°			Contact angle: 25°		
	5S-HSL9xxU			5S-HSL9xxUAD		
	Light preload (GL)	Normal preload (GN)	Medium preload (GM)	Light preload (GL)	Normal preload (GN)	Medium preload (GM)
50	39	127	255	39	177	345
55	49	157	345	49	216	440
60	49	167	345	54	226	440
65	49	167	345	54	226	440
70	74	245	490	78	345	685
75	74	255	490	83	345	685
80	74	255	540	83	345	685
85	98	345	685	108	490	930
90	108	345	735	118	490	980
95	108	345	735	118	490	980
100	127	440	835	137	590	1170
105	127	440	885	137	590	1170
110	127	440	885	137	590	1170
120	167	540	1080	177	785	1570
130	196	685	1370	226	930	1860

**Table 9.12 Eco-friendly air-oil lubricated angular contact ball bearings (HSL0 series)**

Unit: N

Nominal bore diameter $d$ (mm)	Contact angle: 20°			Contact angle: 25°		
	5S-HSL0xx			5S-HSL0xxAD		
	Light preload (GL)	Normal preload (GN)	Medium preload (GM)	Light preload (GL)	Normal preload (GN)	Medium preload (GM)
50	69	235	460	78	305	600
55	78	255	510	78	325	645
60	78	265	530	88	345	685
65	78	265	540	88	345	695
70	98	325	655	108	420	845
75	108	355	695	118	450	900
80	118	400	805	127	520	1 030
85	118	400	815	127	520	1 040
90	137	470	940	157	610	1 220
95	147	480	960	157	620	1 240
100	147	490	990	157	635	1 270
105	167	570	1140	186	725	1450
110	206	695	1400	226	900	1800
120	216	705	1410	226	910	1820
130	305	1020	2030	325	1300	2610

**Table 9.13 Air-oil lubricated high-speed angular ball bearings with re-lubricating hole on the outer ring (HSEW9U series)**

Unit: N

Nominal bore diameter $d$ (mm)	Contact angle: 20°			Contact angle: 25°		
	5S-HSEW9xxU			5S-HSEW9xxUAD		
	Light preload (GL)	Normal preload (GN)	Medium preload (GM)	Light preload (GL)	Normal preload (GN)	Medium preload (GM)
50	39	127	255	39	177	345
55	49	157	345	49	216	440
60	49	167	345	54	226	440
65	49	167	345	54	226	440
70	74	245	490	78	345	685
75	74	255	490	83	345	685
80	74	255	540	83	345	685
85	98	345	685	108	490	930
90	108	345	735	118	490	980
95	108	345	735	118	490	980
100	127	440	835	137	590	1170

**Table 9.14 Air-oil lubricated high-speed angular ball bearings with re-lubricating hole on the outer ring (HSEW0 series)**

Unit: N

Nominal bore diameter $d$ (mm)	Contact angle: 20°			Contact angle: 25°		
	5S-HSEW0xx			5S-HSEW0xxAD		
	Light preload (GL)	Normal preload (GN)	Medium preload (GM)	Light preload (GL)	Normal preload (GN)	Medium preload (GM)
50	69	235	460	78	305	600
55	78	255	510	78	325	645
60	78	265	530	88	345	685
65	78	265	540	88	345	695
70	98	325	655	108	420	845
75	108	355	695	118	450	900
80	118	400	805	127	520	1 030
85	118	400	815	127	520	1 040
90	137	470	940	157	610	1 220
95	147	480	960	157	620	1 240
100	147	490	990	157	635	1 270

**Table 9.15 Grease-lubricated sealed angular contact ball bearings (79CD and AD series)**

Unit: N

Nominal bore diameter $d$ (mm)	Contact angle: 15°			Contact angle: 25°		
	79xxCD/5S-79xxCD			79xxAD/5S-79xxAD		
	Light preload (GL)	Normal preload (GN)	Medium preload (GM)	Light preload (GL)	Normal preload (GN)	Medium preload (GM)
10	10	29	78	—	39	78
12	10	29	78	—	39	78
15	10	29	78	—	49	147
17	10	29	78	—	49	147
20	20	49	98	29	98	196
25	20	49	98	29	98	196
30	20	49	98	29	98	196
35	29	78	196	49	147	294
40	29	78	196	49	147	294
45	39	98	245	49	196	390
50	39	98	245	49	196	390

**Table 9.16 Grease-lubricated sealed angular contact ball bearings (70CD and AD series)**

Unit: N

Nominal bore diameter $d$ (mm)	Contact angle: 15°			Contact angle: 25°		
	70xxCD/5S-70xxCD			70xxAD/5S-70xxAD		
	Light preload (GL)	Normal preload (GN)	Medium preload (GM)	Light preload (GL)	Normal preload (GN)	Medium preload (GM)
10	20	29	98	29	78	147
12	20	29	98	29	78	147
15	20	29	98	29	78	147
17	20	29	98	29	78	147
20	29	78	147	49	147	294
25	29	78	147	49	147	294
30	29	78	147	49	147	294
35	49	147	294	78	294	590
40	49	147	294	78	294	590
45	49	147	294	78	294	590
50	49	147	294	78	294	590

**Table 9.17 High-speed grease-lubricated sealed angular contact ball bearings (BNS9 series)**

Unit: N

Nominal bore diameter <i>d</i> (mm)	Contact angle: 15°			Contact angle: 20°			Contact angle: 25°		
	BNS9xxC/5S-BNS9xxC			BNS9xx/5S-BNS9xx			BNS9xxAD/5S-BNS9xxAD		
	Light preload (GL)	Normal preload (GN)	Medium preload (GM)	Light preload (GL)	Normal preload (GN)	Medium preload (GM)	Light preload (GL)	Normal preload (GN)	Medium preload (GM)
50	29	78	167	39	118	235	39	157	305
55	39	108	206	49	147	305	49	196	390
60	39	108	216	49	157	315	49	196	400
65	39	108	216	49	157	315	49	206	410
70	59	137	275	59	196	400	69	255	520
75	59	137	284	59	206	410	69	265	530
80	59	147	294	59	216	420	69	275	550
85	69	177	345	78	255	510	78	325	655
90	69	177	355	78	265	520	88	335	665
95	69	186	365	78	265	540	88	345	685
100	98	255	510	108	375	755	118	480	970

**Table 9.18 High-speed grease-lubricated sealed angular contact ball bearings (BNS0 series)**

Unit: N

Nominal bore diameter <i>d</i> (mm)	Contact angle: 15°			Contact angle: 20°			Contact angle: 25°		
	BNS0xxC/5S-BNS0xxC			BNS0xx/5S-BNS0xx			BNS0xxAD/5S-BNS0xxAD		
	Light preload (GL)	Normal preload (GN)	Medium preload (GM)	Light preload (GL)	Normal preload (GN)	Medium preload (GM)	Light preload (GL)	Normal preload (GN)	Medium preload (GM)
45	49	118	235	49	177	345	59	226	450
50	59	157	315	69	235	460	78	305	600
55	69	177	345	78	255	510	78	325	645
60	69	186	365	78	265	530	88	345	685
65	69	186	365	78	265	540	88	345	695
70	88	226	450	98	325	655	108	420	845
75	98	235	480	108	355	695	118	450	900
80	108	275	550	118	400	805	127	520	1 030
85	108	275	560	118	400	815	127	520	1 040
90	127	325	645	137	470	940	157	610	1 220
95	127	325	645	147	480	960	157	620	1 240
100	137	345	675	147	490	990	157	635	1 270

**Table 9.19 High-speed sealed angular contact ball bearings (BNT9 series)**

Unit: N

Nominal bore diameter <i>d</i> (mm)	Contact angle: 15°		
	BNT9xx/5S-BNT9xx		
	Light preload (GL)	Normal preload (GN)	Medium preload (GM)
10	10	29	78
12	10	29	78
15	10	29	78
17	10	29	78
20	20	49	98
25	20	49	98
30	20	49	98
35	29	78	196
40	29	78	196
45	39	98	245
50	39	98	245
55	49	118	294
60	49	118	294
65	49	118	294

**Table 9.20 High-speed sealed angular contact ball bearings (BNT0 series)**

Unit: N

Nominal bore diameter <i>d</i> (mm)	Contact angle: 15°		
	BNT0xx/5S-BNT0xx		
	Light preload (GL)	Normal preload (GN)	Medium preload (GM)
10	20	29	98
12	20	29	98
15	20	29	98
17	20	29	98
20	29	78	147
25	29	78	147
30	29	78	147
35	49	147	294
40	49	147	294
45	49	147	294
50	49	147	294
55	98	196	490
60	98	196	490
65	98	196	490
70	98	294	685

**Table 9.21 High-speed sealed angular contact ball bearings (BNT2 series)**

Unit: N

Nominal bore diameter <i>d</i> (mm)	Contact angle: 15°		
	BNT2xx/5S-BNT2xx		
	Light preload (GL)	Normal preload (GN)	Medium preload (GM)
10	20	49	98
12	20	49	98
15	20	49	147
17	20	49	147
20	49	98	294
25	49	98	294
30	49	98	294
35	78	196	490
40	78	196	490
45	98	294	590
50	98	294	590
55	147	390	785
60	147	390	785
65	147	390	785
70	196	490	980
75	196	490	980
80	196	490	980

⑥ Recommended fit for angular contact ball bearings

If the  $d_{mn}$  value is in the range of  $d_{mn} \leq 0.75 \times 10^6$  ( $d_m$ : pitch circle diameter across rolling elements [mm], n: speed [min<sup>-1</sup>]), the fit values shown in **Tables 9.22 and 9.23** are recommended to ensure high accuracies of precision bearings.

If the  $d_{mn}$  value is in the range of  $d_{mn} > 0.75 \times 10^6$ , it is necessary to consider expansion of inner ring caused by centrifugal force. In this case, contact **NTN Engineering** for the recommended fit. As for the fit of the outer ring with the housing, consider the influence of the ambient temperature (such as heat buildup on a built-in motor or the cooling effect of jacket). For technical assistance, contact **NTN Engineering**.

**Table 9.22 Shaft fit** Unit:  $\mu\text{m}$

Nominal bore diameter <i>d</i> mm		Fit of inner ring with shaft
Over	Incl.	
2.5	10	0~2T
10	18	0~2T
18	30	0~2T
30	50	0~3T
50	80	1T~4T
80	120	1T~5T
120	180	2T~7T
180	250	2T~8T

Notes:

- The mean value should be the target value.
  - If the  $d_{mn}$  value of the high-speed machine is in the range of  $d_{mn} > 0.75 \times 10^6$ , it is necessary to increase the amount of interference. In this case, contact **NTN Engineering** for technical assistance.
- T: Tight (Interference) Fit

**Table 9.23 Housing fit** Unit:  $\mu\text{m}$

Nominal outside diameter <i>D</i> mm		Fit of outer ring with housing	
Over	Incl.	Bearing on fixed side	Bearing on free side
10	50	2L~5L	6L~10L
50	80	3L~7L	6L~12L
80	120	4L~9L	8L~13L
120	150	5L~11L	10L~16L
150	180	6L~13L	11L~17L
180	250	7L~15L	13L~20L
250	315	8L~17L	15L~23L

Notes:

- The mean value should be the target value.
- If the  $d_{mn}$  value is in the range of  $d_{mn} > 1.0 \times 10^6$ , spacer width and bearing arrangement, it is necessary to increase the amount of interference.

In this case, contact **NTN Engineering** for technical assistance.  
L: Loose fit

⑦ Duplex angular contact ball bearings

Duplex angular contact ball bearings can be combined in rows of two, three or four bearings to accommodate required specifications.

The back-to-back duplex (DB) arrangement and the face-to-face duplex (DF) arrangement allow for the application of both radial loads and axial loads in both directions. The DB arrangement has a wide space between load points and can handle large moment loads. For this reason, this type of duplex arrangement is preferable for use on the main spindles of machine tools.

The DF arrangement cannot handle large moment loads, but its allowable inclination angle is greater than that of the DB arrangement. The tandem duplex (DT) arrangement can handle both a radial load and large axial load, but this bearing can take the axial load in one direction only. The 4-row duplex (type DTBT) arrangement ensures high rigidity in the radial and axial directions and accommodates high-speed operation. For this reason, this type of duplex bearing is commonly used for the main spindles of machining centers.

Each duplex angular contact ball bearing is manufactured as a set to enable adjustment of the preload and clearance. For this reason, combine only duplex bearings of the same product number.

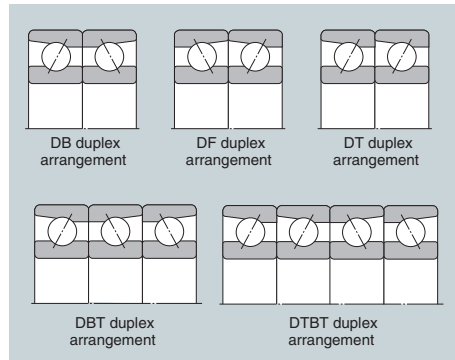


Fig. 9.10



### ⑧ Duplex arrangement codes for angular contact ball bearings

Each duplex ball bearing has a product number and duplex arrangement code etched on its side face. On angular contact ball bearing sets of three or more, each matching bearing has a "<" mark on its outside surface. Be sure to align the "<" mark when assembling the bearings.

Note that duplex angular contact ball bearing types DB and DF do not have the "<" mark. To match them, align the duplex arrangement codes.

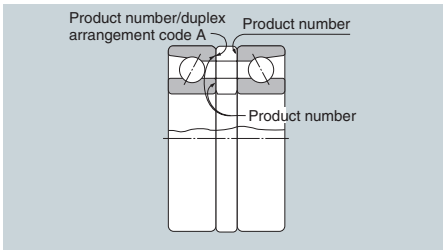


Fig. 9.11

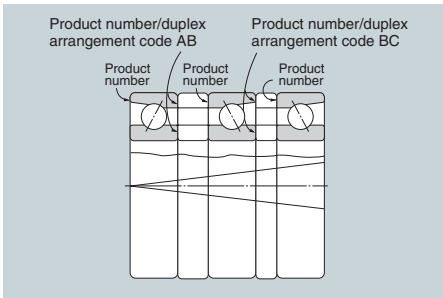


Fig. 9.12

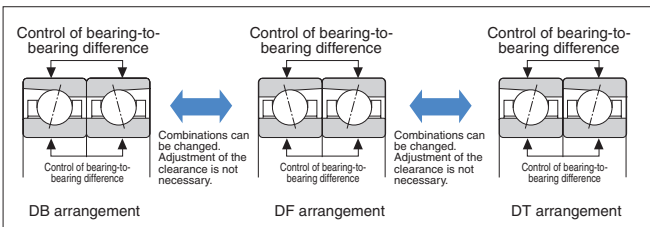


Fig. 9.14 Universal matching

### ⑨ Flush grinding and universal matching

Angular contact ball bearings are often combined for a special purpose. Face-to-face duplex (DF) arrangement, back-to-back duplex (DB) arrangement and tandem duplex (DT) arrangement may be combined in rows of two or more. When combining many bearings, it is important to control the accuracies of the bearings and to align their face heights in a common plane.

#### ■ Flush grinding

"Flush grinding" is a finishing technique in which the front and back faces of the inner and outer rings are aligned with each other to eliminate differences in face height (Fig. 9.13). Such

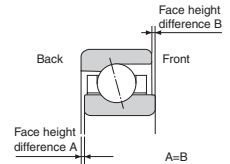


Fig. 9.13 Flush grinding

alignment can ensure the specified clearance and preload for DF, DB, and DT sets, but it is possible only if the combined bearings have the same clearance/preload symbols. The flush grinding technique is employed for standard BNT series, 0 series, and 2 series bearings designed for main spindles of machine tools, and for 2A-BST thrust angular contact ball bearings designed to support ballscrews.

Note: The flush grinding technique is also adopted for other types of angular contact ball bearings. When ordering a bearing, append "G" to the product number to specify the flush ground type. **Example: 7010UC G/GNP4**

#### ■ Universal Matching

In addition to the flush grinding technique, universal matching is employed for duplex angular contact ball bearings. Universal matching controls the bearing-to-bearing dimensional differences in the bore and outside diameters.

NTN can control the bearing-to-bearing difference in the bore and outside diameters to no more than one-third the tolerance (a minimum of  $2 \mu\text{m}$ ). Universal matching is adopted for duplex angular contact ball bearings of JIS class 5 or better. When ordering a bearing, specify the desired number of duplex bearings to be used in combination ("D2" for DB, DF or DT; and "D3" for DBT, DFT or DTT). Alternately, indicate the basic combination and specify universal matching.

If two duplex bearings are combined, "D2" is appended to the product number.

**Example: 7010UC G D2/GNP4**

10 Angular contact ball bearings with ceramic balls

Recently, the main spindles of machining centers, NC machines and other machine tools have been required to operate at much higher speeds. Bearings for main spindles therefore must meet the requirements of high speed and rigidity as well as accuracy. To meet such requirements, many of our customers want the rolling element made of ceramic material. The features of angular contact ball bearings with ceramic balls are described below.

**Limited temperature rise and ultra-high speeds**

The specific gravity of ceramic material is one-half that of bearing steel. In addition, the ball diameter of 5S-HSE type is smaller than that of the standard 70 type. For this reason, use of ceramic balls greatly reduces the influence of centrifugal force (ball sliding and spinning caused by gyratory moment).

As a result, these angular contact ball bearings inhibit temperature buildup and ensure ultra-high speed.

**High bearing rigidity for high accuracy of manufactured products**

The Young's modulus of ceramic material is approximately 1.5 times that of bearing steel. The rigidity of these angular contact ball bearings is therefore greatly increased.

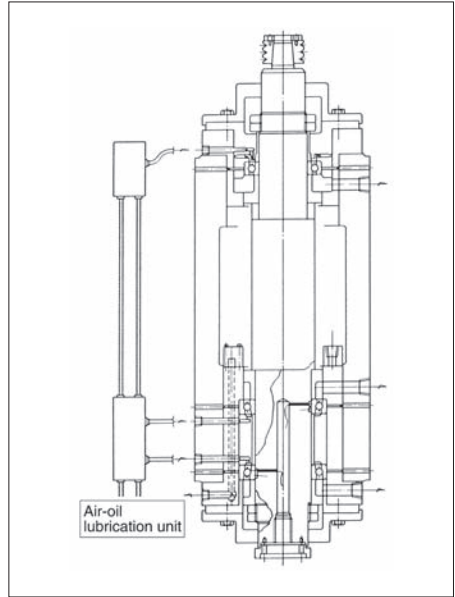


Fig. 9.16 Test rig for measuring temperature rise

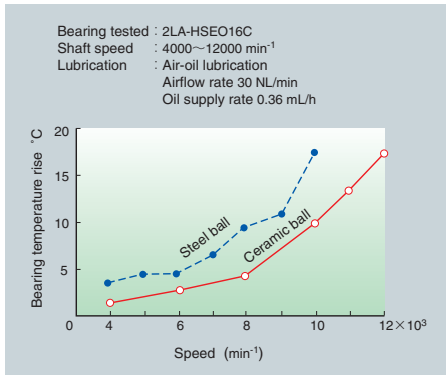


Fig. 9.15 Comparison of temperature rise between bearings with ceramic balls and those with steel balls

Table 9.24 Comparison of physical properties between ceramic and steel balls

Item	Ceramic (Si3N4)	Bearing steel (SUJ2)
Density (g/cm <sup>3</sup> )	3.304	7.8
Young's modulus (GPa)	315	210
Poisson's ratio	0.25	0.3
Thermal expansion (× 10 <sup>-6</sup> /°C)	3.2	12.5
Thermal conductivity ratio (Cal/cm · s · °C)	0.07	0.1~0.12

① Operating life of bearings with ceramic balls

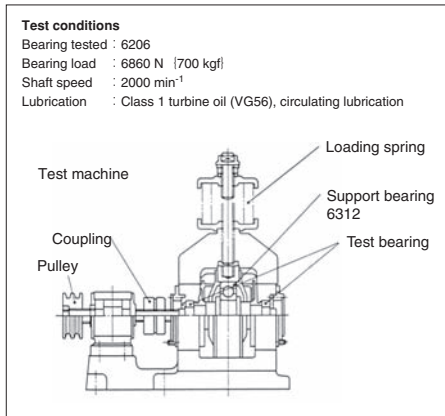


Fig. 9.17 Radial load-type bearing life test machine

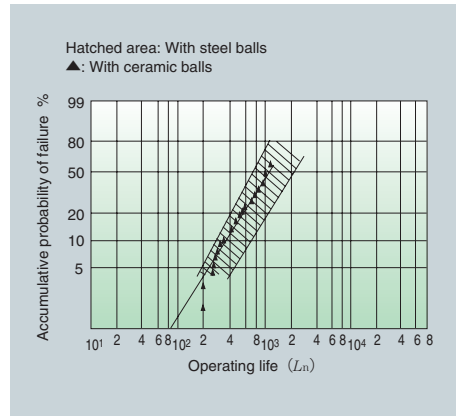


Fig. 9.18 Operating life of ball bearing with ceramic balls

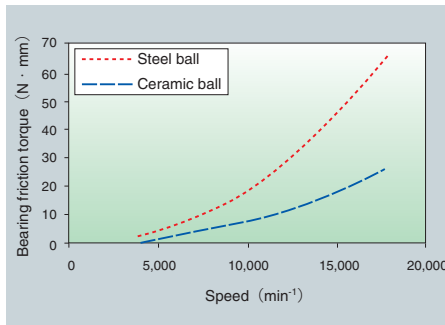


Fig. 9.19 Frictional torque

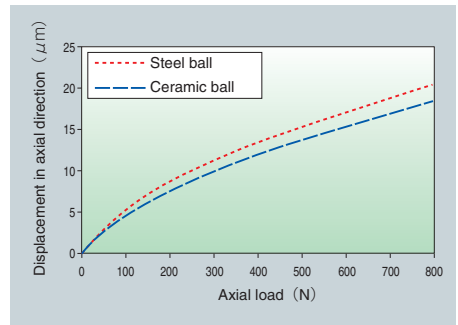


Fig. 9.20 Displacement in axial direction

## 12 Recommended lubrication

Angular contact ball bearings are usually used with grease lubrication or air-oil lubrication. Recommended lubrication specifications are described below.

### ■ Grease lubrication

#### ● Recommended brand of grease

Refer to 7. Lubrication of Bearings, 7-1 Grease lubrication in the Technical Data section.

#### ● Recommended grease fill

$d_{min}$  value  $\leq 0.65 \times 10^6$

15% of the capacity shown in the dimension tables

$d_{min}$  value  $> 0.65 \times 10^6$

12% of the capacity shown in the dimension tables

#### ● Recommended grease filling method

Refer to 6. Handling of Bearings, 6-1 Cleaning of bearings and filling with grease in the Technical Data section.

#### ● Notes

Grease-lubricated sealed angular contact ball bearings (79 LLB/70 LLB type, and BNS type bearings) are prefilled with long-life SE-1 grease. Wipe rust preventive oil from the outside of the bearing with a clean cloth.

### ■ Air-oil lubrication

#### ● Recommended location of nozzle

Refer to 7. Lubrication of Bearings, 7-2 Air-oil lubrication in the Technical Data section.

#### ● Recommended specifications of nozzle

Nozzle bore dia.: 1 to 1.5 mm

Number of nozzles: One nozzle per bearing, depth of nozzle bore should be four to six times as large as the bore diameter.

#### ● Recommended specifications of air-oil

Oil type: Spindle oil

Viscosity grade: ISO VG from 10 to 32 (32 is preferable)

Table 9.25 Air and oil amount

Bearing type	$d_{min}$ value ( $\times 10^6$ )		Oil volume per shot mL	Lubrication intervals min	Oil consumption mL/h	Recommended air consumption *NL/min
	Over	Incl.				
78C,79U,70U, 72C	~	1.0	0.03	8	0.23	20~40
HSE9, HSE0	1.0	~ 1.5		5	0.36	
HSF	1.5	~ 2.6		2	0.90	
HSL	~	2.6		10	0.18	
HSFL	~	2.2				
HSEW	~	2.2				

\* N ℓ /min (Normal liter/minute) ... N ℓ means the volume of air at 0°C and 1 atmosphere.

Note) The amount of oil and air needs to be adjusted to suit the spindle structure or the differences in discharge channels. Set the amounts after checking with actual machine tests.

13 **ULTAGE** Standard angular contact ball bearings 79U and 70U types

ULTAGE 79U and 70U series bearings were developed from standard angular contact ball bearings (79 and 70). Optimized internal design and adoption of a new resin cage allows high-speed operation and ensures high rigidity.

■ **Features**

1. Optimized internal design enables high-speed operation and high rigidity.
2. A new resin cage enables improvement in grease retention for grease lubrication and enhanced performance in feeding and discharge of oil for air-oil lubrication.
3. Bearings are available with either steel or ceramic balls.
4. Three contact angles (15°, 20°, and 30°) are available to handle a wide range of applications.

■ **Bearing specifications**

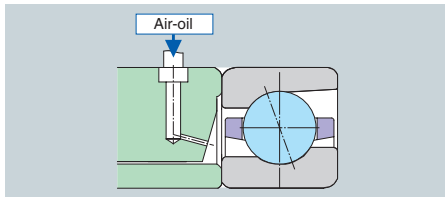


Fig. 9.21 79U and 70U types



Photo 9.1 New resin cage

■ **High-speed operation**

Optimized internal design and adoption of a new resin cage enable stable operation at  $d_{mN}$  value  $0.95 \times 10^6$ , with grease lubrication.

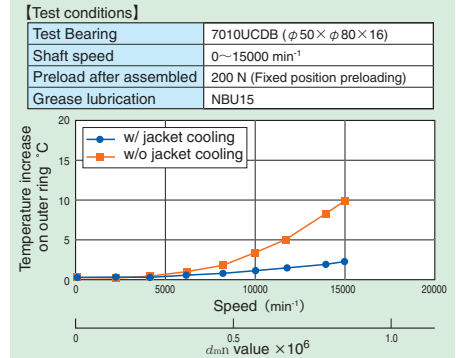


Fig. 9.22 High-speed test with grease lubrication

Stable operation is possible with  $d_{mN}$  value  $1.5 \times 10^6$ , with air-oil lubrication.

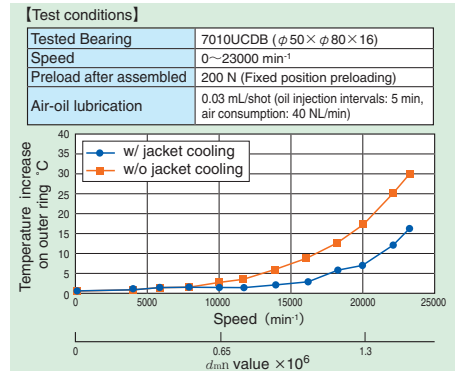
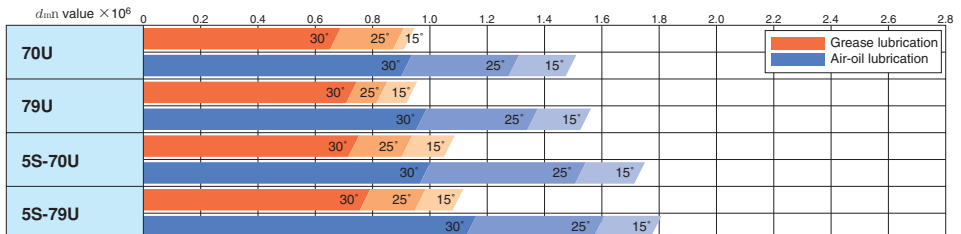


Fig. 9.23 High-speed test with air-oil lubrication

■ **Permissible speed range**



Notes) Permissible speed of each bearing ( $d_{mN}$  value) varies depending on the specifications of the machine on which the bearing is used (motor drive system, cooling system, and construction around the bearing). Consider the optimal choice referring to the above guideline (for two-row arrangement), and then, contact NTN Engineering for technical assistance.

**14 ULTAGE High-speed angular contact ball bearings HSE type**

The HSE type employs a special material featuring greatly improved wear resistance and anti-seizure properties as well as a special surface modification technique. Furthermore, thanks to an optimized internal design, this type achieves high speed, high rigidity and high reliability.

**Features**

1. Adoption of special materials and a unique internal design improve anti-seizure properties (15 times better than the conventional type) and wear resistance (6 times better than of the conventional type).
2. Optimized internal design enables high-speed operation and high rigidity.
3. Bearings are available with either steel or ceramic balls.
4. Three contact angles (15°, 20°, and 25°) are available to handle a wide range of applications.

**Bearing specification**

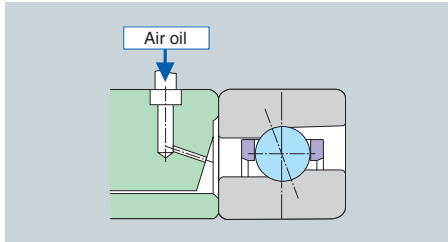
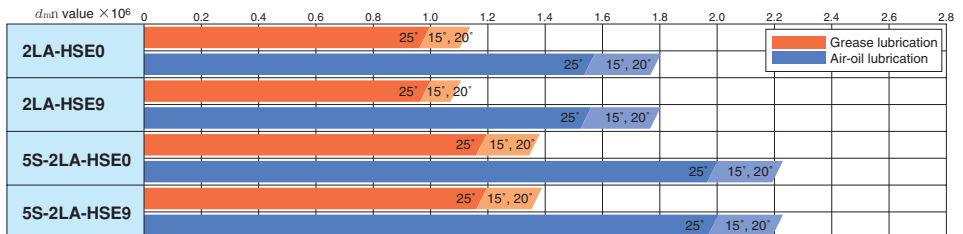


Fig. 9.24 HSE type

**Permissible speed range**



**Preload and low temperature rise**

The 5S-HSE type features high speed and limited temperature increase. Even if its preload is increased after assembly into the spindle, it maintains stable performance at high speeds (Fig. 9.25).

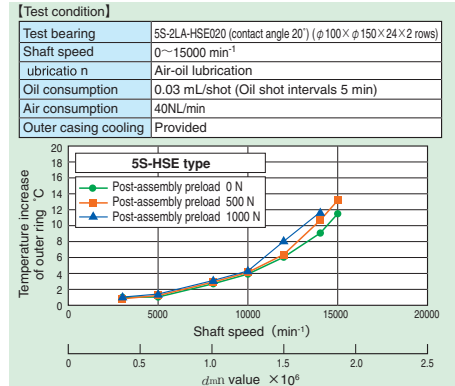


Fig. 9.25 relationship between preload and temperature increase

**Improved main spindle rigidity**

When built into a high-speed main spindle, the preload of the 5S-HSE standard type is maintained, allowing high rigidity (1.9 times greater than a conventional bearing) (Fig. 9.26).

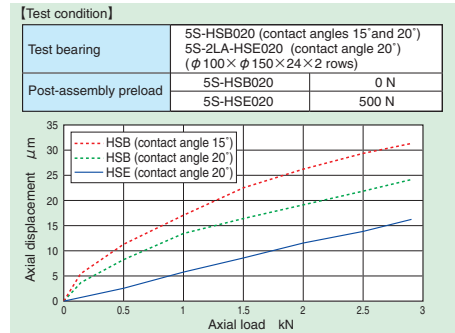


Fig. 9.26 Comparison of rigidity relative to conventional bearing (HSB type) in terms of post-assembly preload

**15 ULTAGE Super high-speed angular contact ball bearings HSF type**

The HSF type realizes further improvement in high-speed running and inhibited temperature rise by adoption of smaller diameter ceramic balls, while retaining features of the HSE type. This type attains  $d_{m1}$  values as high as  $2.6 \times 10^6$  with fixed pressure preloading.

**Features**

1. Adoption of special materials and a unique internal design improve anti-seizure property (15 times better than the conventional type) and wear resistance (6 time better than the conventional type).
2. Optimized internal design enables high-speed operation and high rigidity.
3. Ceramic balls are used.
4. Initial contact angle is set to  $25^\circ$  to accommodate the change in contact angle during super high-speed operation.

**Bearing specification**

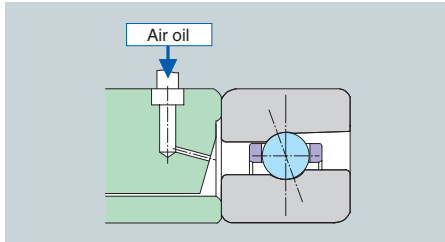


Fig. 9.27 HSF type

**Low temperature rise**

Super high-speed 5S-HSF series angular contact ball bearings utilize smaller balls than those of the high-speed HSE series. This reduces heating due to centrifugal force and ensures lower temperature rise. Thus, the 5S-HSF type boasts an approximately 10% reduction in temperature rise as compared to the 5S-HSE type. (Fig. 9.28)

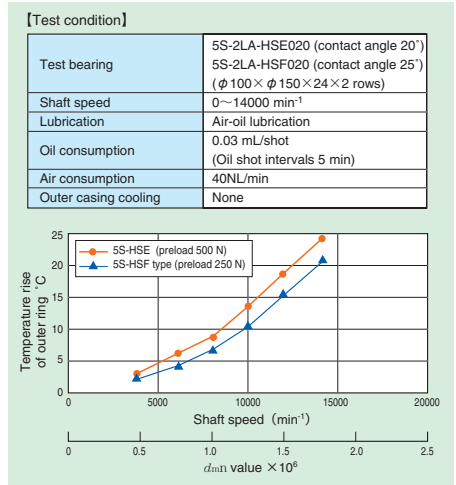
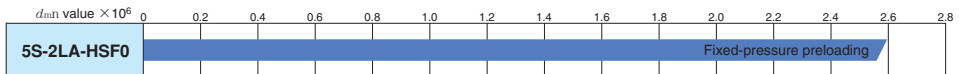


Fig. 9.28 Comparison of temperature rise

**Permissible speed range**



Notes) Permissible speed of each bearing ( $d_{m1}$  value) varies depending on the specifications of the machine on which the bearing is used (motor drive system, cooling system, and construction around the bearing). Consider the optimal choice referring to the above guideline (for two-row arrangement) and contact NTN Engineering for technical assistance.

16 **ULTAGE** Eco-friendly air-oil lubricated angular contact ball bearings HSL type HSFL type

The HSL/HSFL type is an advanced variation of the HSE/HSF type, characterized by incorporation of NTN's unique eco-conscious lubrication technology. The HSL type helps decrease oil mist emissions and consumption of air and oil, improving the working environment for machine tool operators and reducing energy consumption.

**Features**

1. Adoption of special materials and a unique internal design improve anti-seizure properties (15 times better compared with the conventional type) and wear resistance (6 times better than the conventional type).
2. Bearings are available with either steel or ceramic balls (HSFL is available with ceramic balls only).
3. Adoption of eco-friendly nozzle reduces noise (reduction of 2 to 8 dBA), air consumption (reduction of 50 to 75%) and oil consumption (reduction of 20 to 90%)

**Bearing specification**

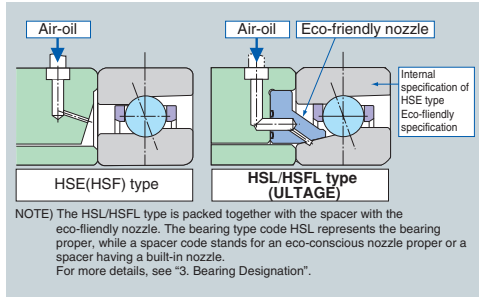
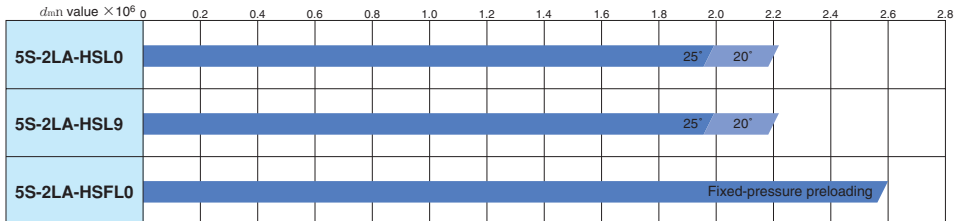


Fig. 9.29 HSL and HSFL types

**Permissible speed range**



Notes) Permissible speed of each bearing ( $d_{min}$  value) varies depending on the specifications of the machine on which the bearing is used (motor drive system, cooling system, and construction around the bearing). Consider the optimal choice referring to the above guideline (for two-row arrangement) and contact NTN Engineering for technical assistance.

**Data 1**

In the high-speed region of 10000 min<sup>-1</sup>, the noise level of the HSL type is 6 dBA to 8 dBA lower than that of the conventional type (HSC type) (Fig. 9.30).

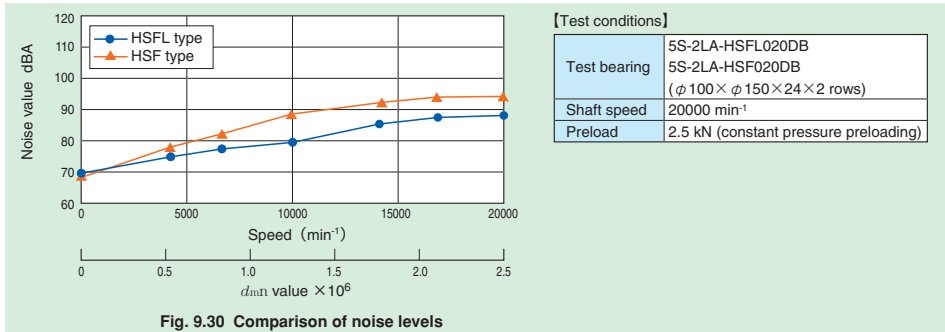
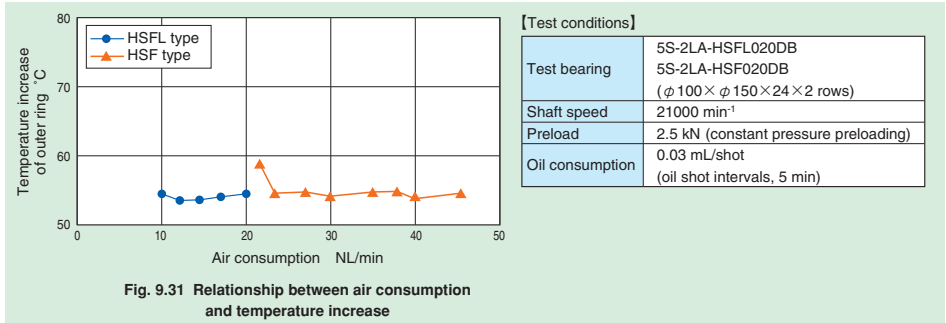


Fig. 9.30 Comparison of noise levels



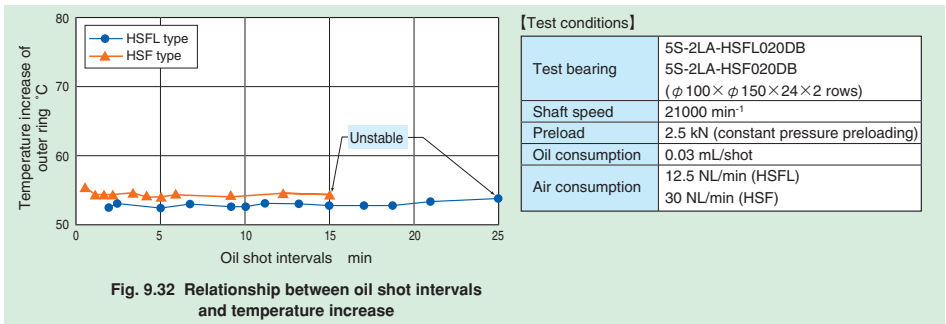
**Data 2**

For 5S-HSFL type bearings, the temperature of the outer rings remains stable even with an air consumption as low as 10 NL/min (50 to 25% of the recommended air consumption for standard bearings) at a speed of 21000 min<sup>-1</sup> ( $d_{mN}$  value  $2.6 \times 10^6$ ) (Fig. 9.31).



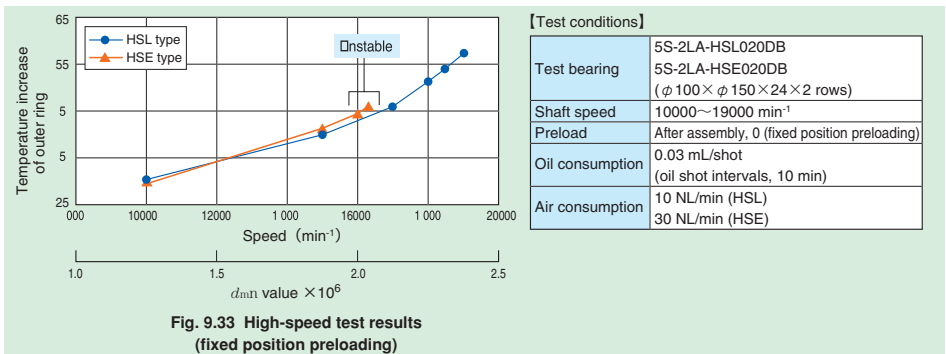
**Data 3**

The 5S-HSFL type bearings can operate at 21000 min<sup>-1</sup> ( $d_{mN}$  value  $2.6 \times 10^6$ ) with oil shot intervals of 21 min (reduction of 20 to 90% as compared with the recommended oil consumption for standard bearings) (Fig. 9.32).



**Data 4**

5S-HSL type bearings can reliably run at a speed of 19000 min<sup>-1</sup> (fixed position preloading) (Fig. 9.33) with both decrease air and oil consumption.



17 **ULTAGE** Air-oil lubricated high-speed angular ball bearings with re-lubricating hole on the outer ring – HSEW Type

HSEW type is an air-oil lubricated high-speed angular ball bearing equipped with re-lubricating holes on the outer ring of the HSE type. Because there is no requirement for providing a nozzle hole on the spacer, the spacer width can be kept short, contributing to the more compact main spindle and improvement of spindle rigidity due to the placement of the bearings on the tool tip side.

In addition, lubrication reliability is increased due to the direct lubrication from the outer ring, enabling the reduction of air consumption and the supplied oil amount.

■ **Bearing specification**

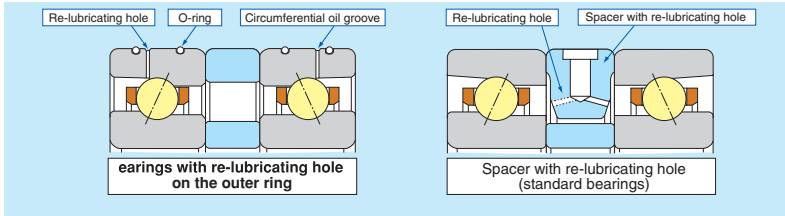


Fig. 9.34 HSEW Type

■ **Features**

1. Compact main spindle design is possible due to the shorter spacer
2. Higher re-lubricating efficiency by the direct lubrication from the outer ring
3. Reduced noise level due to the air reduction effect

■ **Permissible speed range**



Notes) Permissible speed of each bearing ( $d_{min}$  value) varies depending on the specifications of the machine on which the bearing is used (motor drive system, cooling system, and construction around the bearing). Consider the optimal choice referring to the above guideline (for two-row arrangement) and contact NTN Engineering for technical assistance.

■ **About chamfering of re-lubricating hole on the housing**

Ensure to provide chamfering on the re-lubricating hole of the housing to avoid damage of outer O-ring when the HSEW type is inserted into the housing (Fig. 9.35).

We recommend that chamfering is only applied to the hole.

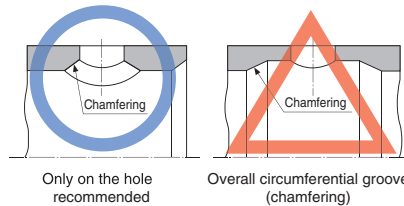


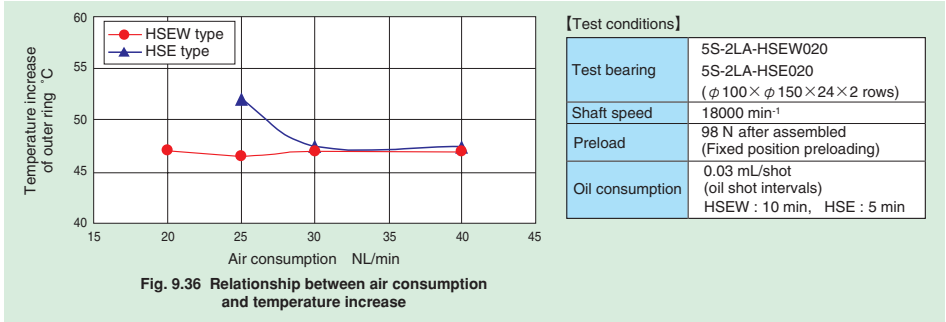
Fig. 9.35 Chamfering of re-lubricating hole on the housing

■ **About phases of re-lubricating hole on the housing and re-lubricating hole on the outer ring**

For producing the air reduction effect, be sure to stagger the position of re-lubricating hole on the housing and re-lubricating hole on the outer ring.

**Data 1**

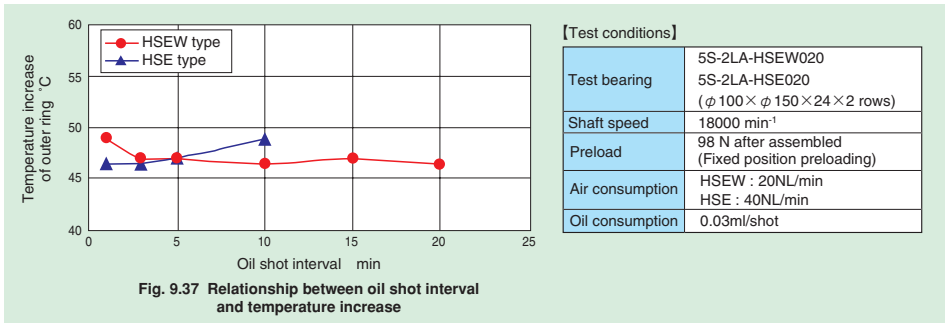
For the HSEW type bearings, the temperature of the outer rings remains stable even with an air consumption as low as 20 Nℓ/min (1/2 of the recommended air consumption for standard bearings) at a speed of 18,000 min<sup>-1</sup> ( $d_{min}$  value  $2.25 \times 10^6$ ) (Fig. 9.36).



**Fig. 9.36 Relationship between air consumption and temperature increase**

**Data 2**

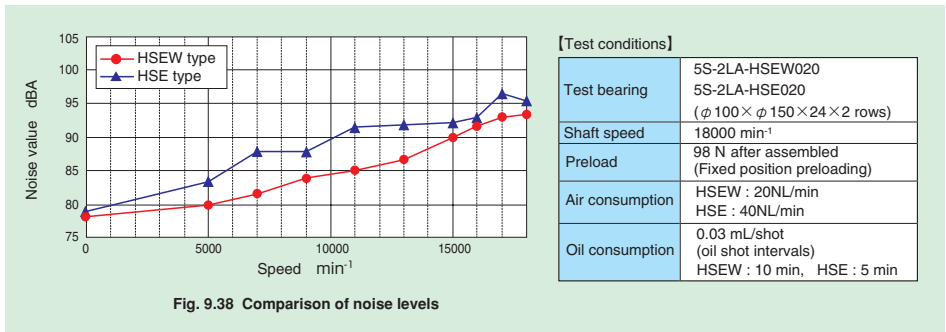
The HSEW type bearings can operate at 18,000 min<sup>-1</sup> ( $d_{min}$  value  $2.25 \times 10^6$ ) with an oil shot interval of 20 min (1/4 of the recommended oil consumption for standard bearings) (Fig. 9.37).



**Fig. 9.37 Relationship between oil shot interval and temperature increase**

**Data 3**

The HSEW type has achieved reduced noise level compared with the HSE type (Fig. 9.38).



**Fig. 9.38 Comparison of noise levels**

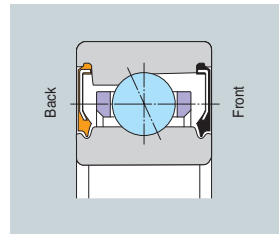
**18 ULTAGE Grease-lubricated sealed standard angular contact ball bearings**  
**79LLB and 70LLB, 5S-79LLB and 5S-70LLB types**

The 79LLB and 70LLB types are grease-lubricated, eco-friendly bearings that can achieve stable high-speed operation with limited temperature rise. They can allow, longer service life and preservation of healthy working environment for rotating tools with shaft diameters less than 50 mm.

**Features**

1. Internal design is optimized for high-speed operation and limited temperature rise.
2. Longer grease life due to adoption of special grease and non-contact seals for grease retention.
3. Contact angles of 15° and 25° are available.
4. The standard types meet special precision P42 requirements (dimensional precision JIS P4 and running accuracy JIS P2).
5. Seals of different colors are used for front (black) and back (orange) sides. Bearing configuration can be easily identified by color.
6. Available with either steel or ceramic balls.

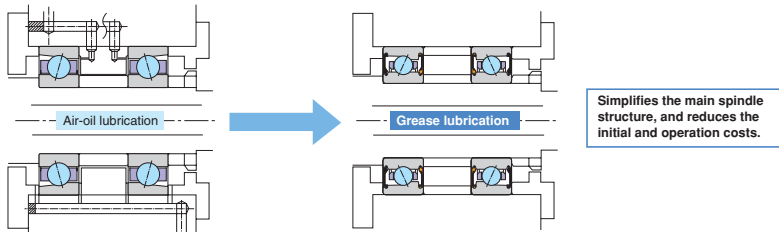
**Bearing specifications**



**Fig. 9.39**  
**79LLB and 70LLB types**

**Simplified main spindle configuration**

Due to the optimized internal structure, the 79LLB and 70LLB types can reliably run at a higher speed with grease lubrication. The grease lubricating system is virtually free from oil mist emission, and contributes to a simpler main spindle structure, reduction in environmental impact and decrease in cost. (Fig. 9.40)



**Fig. 9.40** Modification of lubrication system (air-oil lubrication to grease lubrication)

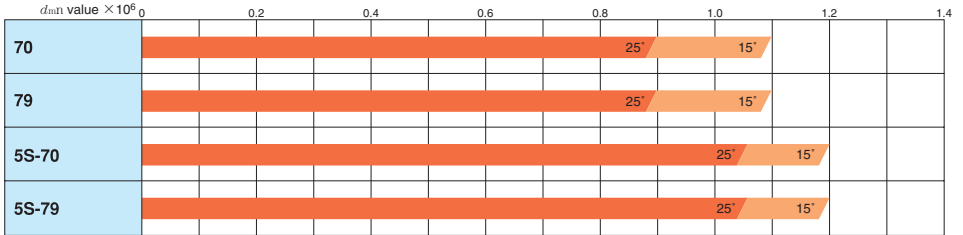
**Easier handling with 79LLB and 70LLB types**

The 79LLB and 70LLB types are pre-filled with grease. They can be readily used after only wiping away rust preventive oil. Seals of different colors are used for the front and back sides of the bearing. Black seals are used for the front sides and orange seals are used for the back sides, so configurations are readily identified by colors. (Table 9.26)

**Table 9.26** Bearing Combinations and Seal Colors

DB set (back faces in combination)	DF set (front faces in combination)
<p>Orange seal + Orange seal</p>	<p>Black seal + Black seal</p>

■ Permissible speed range



Notes) Permissible speed of each bearing ( $d_{mn}$  value) varies depending on the specifications of the machine on which the bearing is used (motor drive, stem cooling system, and construction around the bearing). Consider the optimal choice referring to the above guideline (for two-row arrangement) and contact NTN engineering for technical assistance.

■ High-speed test

Optimization of the internal design promotes stable operation of  $d_{mn}$  value  $1.1 \times 10^6$ . (Figs.9.41 and 9.42)

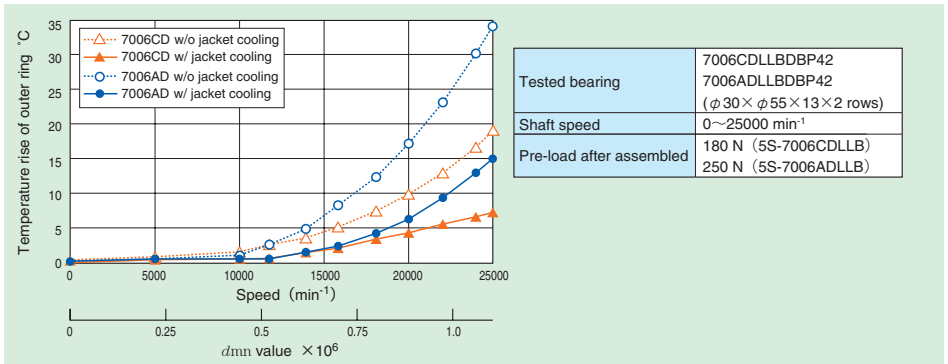


Fig. 9.41 High-speed test results (7006CD, contact angle 15°) (7006AD, contact angle 25°)

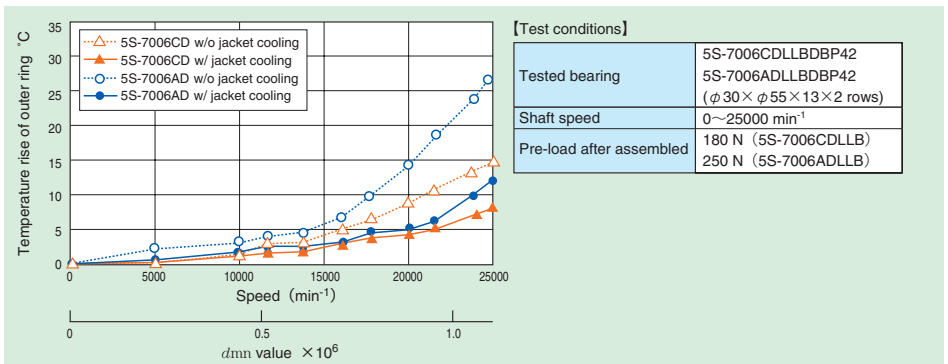


Fig. 9.42 High-speed test results (5S-7006CD, contact angle 15°) (5S-7006AD, contact angle 25°)

19 **ULTAGE** Grease-lubricated sealed angular contact ball bearings BNS LLB and 5S-2LA-BNS LLB types

By the optimized material and internal structure, BNS LLB type bearings have excellent performance at higher speeds. This helps to reduce pollution and cost.

**Features**

1. Adoption of special materials and unique internal design improve anti-seizure properties (15 times better than the conventional type) and wear resistance (6 times better than the conventional type).
2. Optimized internal design enables high-speed operation and high rigidity.
3. Available with either steel or ceramic balls.
4. Adoption of grease pockets, special grease, and non-contact seals improves service life of the grease.

**Bearing specification**

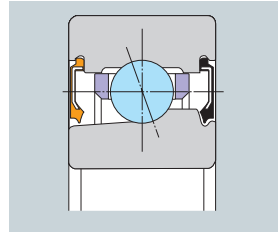


Fig. 9.43 BNS LLB type

**Simplified main spindle configuration**

BNS LLB type bearings can reliably operate at a higher speed with grease lubrication. The grease lubrication system is virtually free from oil mist emission can simplify the main spindle structure, reduce pollution and decrease cost (Fig. 9.44).

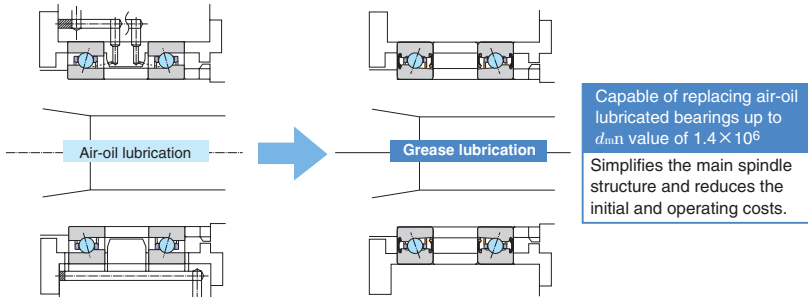


Fig. 9.44 Modification of lubrication system (air-oil lubrication to grease lubrication)

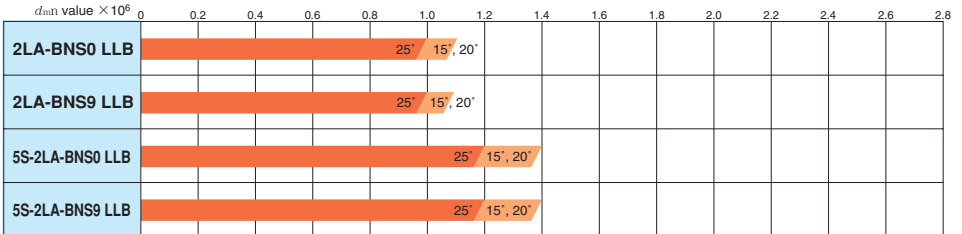
**Easier handling with BNS LLB type**

The BNS LLB type has been packed with grease in advance. They can be used after wiping away rust preventive oil. Seals in different colors are used for the front and back sides of the bearings. Black seals are used for the front sides and orange seals are used for the back sides, so configurations can be easily identified by color. (Table 9.27)

Table 9.27 Bearing Combinations and Seal Colors

DB set (back faces in combination)	DF set (front faces in combination)
<p style="text-align: center;">Orange seal + Orange seal</p>	<p style="text-align: center;">Black seal + Black seal</p>

**Permissible speed range**



Notes) Permissible speed of each bearing ( $d_{mn}$  value) varies depending on the specifications of the machine on which the bearing is used (motor drive system, cooling system, and construction around the bearing). Consider the optimal choice referring to the above guideline (for two-row arrangement) and contact NTN Engineering for technical assistance.

**Temperature increase**

5S-2LA-BNS LLB type bearings exhibit stable temperature increase up to a  $d_{mn}$  value of  $1.4 \times 10^6$  (Fig. 9.45).

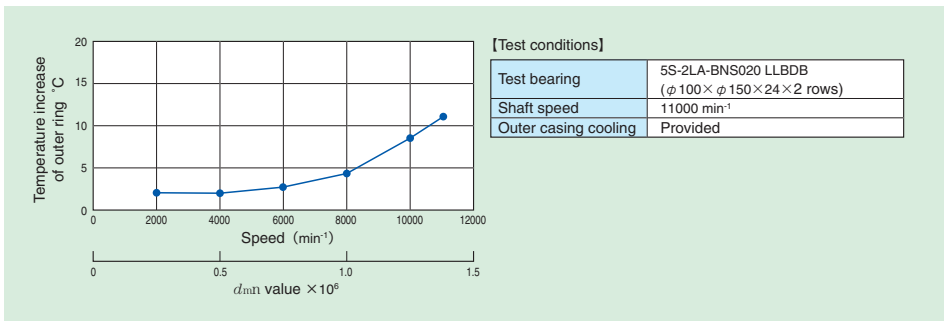


Fig. 9.45 High-speed test results

**Durability test**

As a result of optimized design (such as grease reservoir) and special grease, 5S-2LA-BNS LLB type bearing have successfully achieved continuous operation in excess of 20,000 hours at a  $d_{mn}$  value of  $1.4 \times 10^6$  (Fig. 9.46).

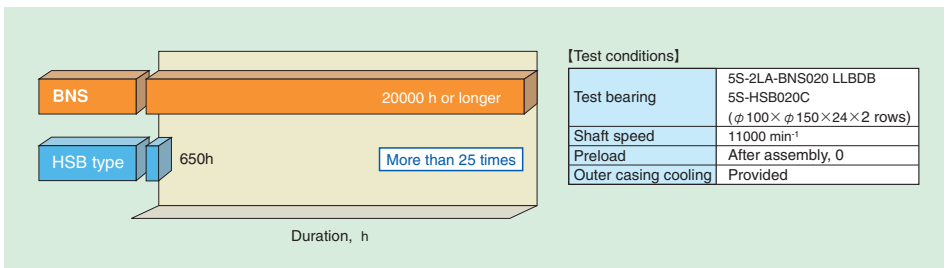
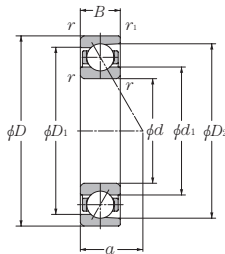


Fig. 9.46 Durability test results

## 20 Dimension tables for angular contact ball bearings

### Standard angular contact ball bearings (steel ball type) 78 series

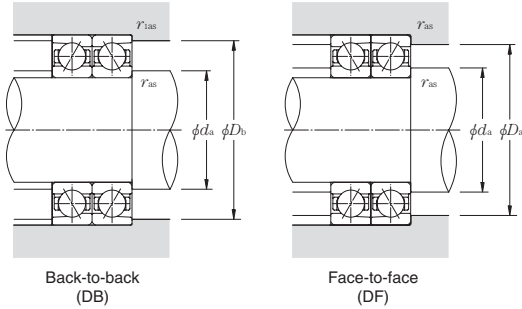
Contact angle 15°  $d$  25~170mm



Part number	Boundary dimensions						Basic load ratings				Static axial load capacity		Factor $f_0$	Limiting speed	
	mm						dynamic kN		dynamic kgf		kN	kgf		min <sup>-1</sup>	
	$d$	$D$	$B$	$r_{1s}$ min <sup>①</sup>	$r_{1s}$ min <sup>①</sup>	$C_r$	$C_{or}$	$C_r$	$C_{or}$	grease lubrication				oil lubrication	
7805C	25	37	7	0.3	0.15	5.05	3.85	515	390	1.04	106	16.2	27 100	36 100	
7806C	30	42	7	0.3	0.15	5.35	4.50	545	460	1.20	122	16.5	23 300	31 100	
7807C	35	47	7	0.3	0.15	5.80	5.25	590	535	1.41	144	16.4	20 500	27 300	
7808C	40	52	7	0.3	0.15	6.05	5.75	615	585	1.57	160	16.2	18 300	24 300	
7809C	45	58	7	0.3	0.15	6.25	6.25	640	640	1.73	176	16.0	16 300	21 700	
7810C	50	65	7	0.3	0.15	7.90	8.05	805	820	2.31	236	16.1	14 600	19 500	
7811C	55	72	9	0.3	0.15	13.1	12.7	1 330	1 300	5.55	565	16.4	13 200	17 600	
7812C	60	78	10	0.3	0.15	13.4	13.6	1 370	1 390	6.00	610	16.3	12 200	16 200	
7813C	65	85	10	0.6	0.3	14.1	14.9	1 440	1 520	5.30	540	16.2	11 200	14 900	
7814C	70	90	10	0.6	0.3	14.5	15.8	1 470	1 610	7.10	720	16.1	10 500	14 000	
7815C	75	95	10	0.6	0.3	14.8	16.7	1 510	1 700	6.00	615	16.0	9 900	13 200	
7816C	80	100	10	0.6	0.3	15.1	17.6	1 540	1 790	7.95	810	15.9	9 300	12 400	
7817C	85	110	13	1	0.6	22.1	24.7	2 250	2 520	10.7	1 090	16.1	8 600	11 500	
7818C	90	115	13	1	0.6	22.7	26.1	2 320	2 670	10.5	1 070	16.1	8 200	10 900	
7819C	95	120	13	1	0.6	23.4	27.6	2 380	2 820	12.1	1 240	16.0	7 800	10 400	
7820C	100	125	13	1	0.6	23.5	28.3	2 400	2 890	12.5	1 270	16.0	7 500	10 000	
7821C	105	130	13	1	0.6	24.1	29.8	2 460	3 050	13.2	1 340	15.9	7 100	9 500	
7822C	110	140	16	1	0.6	34.5	42.5	3 550	4 350	21.0	2 140	16.1	6 700	9 000	
7824C	120	150	16	1	0.6	35.0	44.5	3 600	4 550	22.1	2 260	16.0	6 200	8 300	
7826C	130	165	18	1.1	0.6	47.0	59.5	4 750	6 050	28.4	2 900	16.1	5 700	7 600	
7828C	140	175	18	1.1	0.6	47.5	62.5	4 850	6 350	30.0	3 050	16.0	5 300	7 100	
7830C	150	190	20	1.1	0.6	60.5	79.5	6 150	8 100	48.5	4 950	16.1	4 900	6 600	
7832C	160	200	20	1.1	0.6	62.0	83.5	6 300	8 500	41.0	4 200	16.0	4 700	6 200	
7834C	170	215	22	1.1	0.6	76.0	102	7 750	10 400	49.0	4 950	16.1	4 400	5 800	

① Minimum allowable value for corner radius dimension  $r$  or  $r_1$ .





**Dynamic equivalent radial load**

$$P_r = X F_r + Y F_a$$

$\frac{F_a}{F_r} \frac{F_a}{C_{or}}$	e	Single row / Tandem				Back-to-back / Face-to-face			
		$F_a/F_r \leq e$		$F_a/F_r > e$		$F_a/F_r \leq e$		$F_a/F_r > e$	
		X	Y	X	Y	X	Y	X	Y
0.178	0.38				1.47			1.65	2.39
0.357	0.4				1.4			1.57	2.28
0.714	0.43				1.3			1.46	2.11
1.07	0.46				1.23			1.38	2
1.43	0.47				1.19			1.34	1.93
2.14	0.5	1	0	0.44	1.12	1	0.72	1.26	1.82
3.57	0.55				1.02			1.14	1.66
5.35	0.56				1			1.12	1.63
7.14	0.56				1			1.12	1.63

**Static equivalent radial load**

$$P_{or} = X_o F_r + Y_o F_a$$

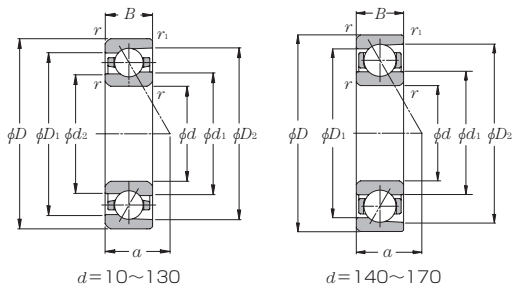
Single row / Tandem		Back-to-back / Face-to-face	
$X_o$	$Y_o$	$X_o$	$Y_o$
0.5	0.46	1	0.92

When  $P_{or} < F_r$  with single-row or tandem arrangement,  $P_{or} = F_r$ .

Load center mm	Internal free space cm <sup>3</sup>	Mass kg	Reference dimensions			Abutment and fillet dimensions					Part number
			mm			mm					
a	Single-row (approx.)	Single-row (approx.)	d <sub>1</sub>	D <sub>1</sub>	D <sub>2</sub>	d <sub>a</sub> min	D <sub>a</sub> max	D <sub>b</sub> max	r <sub>as</sub> max	r <sub>1as</sub> max	
7.7	0.8	0.021	28.6	33.2	34.6	27.5	34.5	35.8	0.3	0.15	7805C
8.3	1.1	0.025	33.6	38.4	39.6	32.5	39.5	40.8	0.3	0.15	7806C
9.0	1.3	0.028	38.6	43.4	44.6	37.5	44.5	45.8	0.3	0.15	7807C
9.7	1.4	0.031	43.6	48.4	49.6	42.5	49.5	50.8	0.3	0.15	7808C
10.4	1.6	0.039	49.1	53.9	55.1	47.5	55.5	56.8	0.3	0.15	7809C
11.2	1.8	0.049	54.8	60.2	61.6	52.5	62.5	63.8	0.3	0.15	7810C
13.0	3.2	0.079	60.1	66.9	69.2	57.5	69.5	70.8	0.3	0.15	7811C
14.3	3.9	0.10	65.6	72.4	74.7	62.5	75.5	76.8	0.3	0.15	7812C
15.1	4.4	0.12	71.4	78.6	80.7	69.5	80.5	82.5	0.6	0.3	7813C
15.7	5.1	0.13	76.6	83.4	85.7	74.5	85.5	87.5	0.6	0.3	7814C
16.4	5.0	0.14	81.4	88.6	90.7	79.5	90.5	92.5	0.6	0.3	7815C
17.1	5.7	0.15	86.6	93.4	95.7	84.5	95.5	97.5	0.6	0.3	7816C
19.6	9.8	0.26	93.1	101.9	104.9	90.5	104.5	105.5	1	0.6	7817C
20.3	11	0.27	98.0	107.0	109.8	95.5	109.5	110.5	1	0.6	7818C
20.9	11	0.28	103.1	111.9	114.8	100.5	114.5	115.5	1	0.6	7819C
21.6	12	0.30	108.1	116.9	119.8	105.5	119.5	120.5	1	0.6	7820C
22.3	13	0.31	113.1	122.0	124.8	110.5	124.5	125.5	1	0.6	7821C
24.8	19	0.49	119.8	130.2	134.0	115.5	134.5	135.5	1	0.6	7822C
26.1	20	0.52	129.8	140.2	144.0	125.5	144.5	145.5	1	0.6	7824C
28.8	28	0.91	141.3	153.7	158.1	137	158	160.5	1	0.6	7826C
30.1	30	0.97	151.3	163.7	168.1	147	168	170.5	1	0.6	7828C
32.8	45	1.33	163.4	177.1	182.2	157	183	185.5	1	0.6	7830C
34.2	46	1.41	172.9	187.1	192.2	167	193	195.5	1	0.6	7832C
36.8	53	1.87	184.4	200.6	206.3	177	208	210.5	1	0.6	7834C

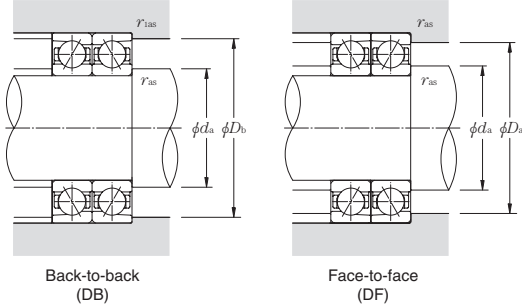
## ULTAGE Standard angular contact ball bearings (steel ball type) 79 series

Contact angle 15°  $d = 10 \sim 170$ mm



Part number	Boundary dimensions						Basic load ratings				Static axial load capacity		Factor	Limiting speed	
	mm						dynamic		static		kN	kgf		min <sup>-1</sup>	
	<i>d</i>	<i>D</i>	<i>B</i>	<i>r</i> <sub>s min</sub>	<i>r</i> <sub>1s min</sub>	<i>r</i> <sub>2s min</sub>	<i>C<sub>r</sub></i>	<i>C<sub>or</sub></i>	<i>C<sub>r</sub></i>	<i>C<sub>or</sub></i>				<i>f<sub>o</sub></i>	grease lubrication
7900UC	10	22	6	0.3	0.15	3.20	1.65	325	169	2.40	245	14.2	73 200	117 200	
7901UC	12	24	6	0.3	0.15	3.35	1.86	340	189	2.61	267	14.7	65 100	104 100	
7902UC	15	28	7	0.3	0.15	5.10	2.90	520	296	3.85	395	14.4	54 500	87 200	
7903UC	17	30	7	0.3	0.15	5.35	3.20	545	325	4.15	425	14.8	49 900	79 800	
7904UC	20	37	9	0.3	0.15	7.65	4.90	780	500	6.45	655	14.9	41 100	65 800	
7905UC	25	42	9	0.3	0.15	8.15	5.75	835	590	7.35	750	15.5	35 000	56 000	
7906UC	30	47	9	0.3	0.15	8.60	6.60	880	675	8.20	840	15.9	30 400	48 700	
7907UC	35	55	10	0.6	0.3	13.7	10.3	1 400	1 050	13.7	1 400	15.5	26 000	41 700	
7908UC	40	62	12	0.6	0.3	14.5	11.8	1 480	1 200	15.4	1 570	15.9	23 000	36 800	
7909UC	45	68	12	0.6	0.3	17.9	14.8	1 830	1 510	19.4	1 980	15.8	20 700	33 200	
7910UC	50	72	12	0.6	0.3	18.9	16.6	1 930	1 700	21.4	2 190	16.1	19 200	30 700	
7911UC	55	80	13	1	0.6	19.7	18.5	2 010	1 890	23.4	2 390	16.3	17 400	27 800	
7912UC	60	85	13	1	0.6	20.5	20.3	2 090	2 080	25.5	2 600	16.5	16 200	25 900	
7913UC	65	90	13	1	0.6	20.8	21.2	2 120	2 160	26.5	2 700	16.5	15 100	24 200	
7914UC	70	100	16	1	0.6	29.7	30.0	3 050	3 100	38.0	3 850	16.4	13 800	22 100	
7915UC	75	105	16	1	0.6	30.0	31.5	3 050	3 250	39.5	4 000	16.5	13 000	20 800	
7916UC	80	110	16	1	0.6	30.5	33.0	3 100	3 350	41.0	4 200	16.5	12 300	19 600	
7917UC	85	120	18	1.1	0.6	41.0	44.0	4 200	4 500	54.0	5 500	16.5	11 400	18 300	
7918UC	90	125	18	1.1	0.6	41.5	46.0	4 250	4 700	56.0	5 700	16.6	10 900	17 400	
7919UC	95	130	18	1.1	0.6	42.5	47.5	4 300	4 850	58.0	5 950	16.5	10 400	16 700	
7920UC	100	140	20	1.1	0.6	54.5	61.0	5 550	6 200	76.5	7 800	16.5	9 800	15 600	
7921UC	105	145	20	1.1	0.6	55.0	63.5	5 600	6 500	79.5	8 100	16.6	9 400	15 000	
7922UC	110	150	20	1.1	0.6	56.0	65.5	5 700	6 700	82.5	8 400	16.5	9 000	14 400	
7924UC	120	165	22	1.1	0.6	69.0	81.5	7 050	8 300	100	10 200	16.6	8 200	13 200	
7926UC	130	180	24	1.5	1	85.0	102	8 650	10 400	128	13 000	16.5	7 600	12 100	
7928CT1B	140	190	24	1.5	1	83.5	101	8 500	10 300	48.0	4 900	16.5	5 100	6 600	
7930CT1B	150	210	28	2	1	108	132	11 000	13 400	60.5	6 200	16.5	4 700	6 100	
7932CT1B	160	220	28	2	1	109	136	11 100	13 900	63.0	6 400	16.5	4 400	5 700	
7934CT1B	170	230	28	2	1	113	145	11 500	14 800	79.0	8 050	16.4	4 200	5 400	

① Minimum allowable value for corner radius dimension *r* or *r*<sub>1</sub>.  
A part number containing a suffix **U** means an **ULTAGE Series**.



### Dynamic equivalent radial load

$$P_r = X F_r + Y F_a$$

$r_{as}/F_a$ $C_{or}$	$e$	Single row / Tandem				Back-to-back / Face-to-face			
		$F_a/F_r \leq e$		$F_a/F_r > e$		$F_a/F_r \leq e$		$F_a/F_r > e$	
		X	Y	X	Y	X	Y	X	Y
0.178	0.38				1.47			1.65	2.39
0.357	0.4				1.4			1.57	2.28
0.714	0.43				1.3			1.46	2.11
1.07	0.46				1.23			1.38	2
1.43	0.47				1.19			1.34	1.93
2.14	0.5				1.12		1	1.26	1.82
3.57	0.55			0.44	1.02			1.14	1.66
5.35	0.56	1	0		1			1.12	1.63
7.14	0.56				1			1.12	1.63

### Static equivalent radial load

$$P_{or} = X_o F_r + Y_o F_a$$

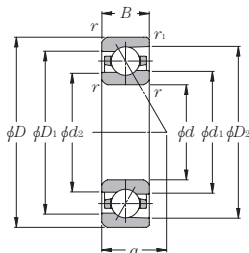
Single row / Tandem		Back-to-back / Face-to-face	
$X_o$	$Y_o$	$X_o$	$Y_o$
0.5	0.46	1	0.92

When  $P_{or} < F_r$  with single-row or tandem arrangement,  $P_{or} = F_r$ .

Load center mm	Internal free space cm <sup>3</sup>	Mass kg	Reference dimensions				Abutment and fillet dimensions					Part number
			mm				mm					
$a$	Single-row (approx.)	Single-row (approx.)	$d_1$	$d_2$	$D_1$	$D_2$	$d_a$ min	$D_a$ max	$D_b$ max	$r_{as}$ max	$r_{ias}$ max	
5.2	0.4	0.01	14.3	13.5	17.7	19.4	12.5	19.5	20.8	0.3	0.15	7900UC
5.4	0.4	0.01	16.3	15.5	19.7	21.3	14.5	21.5	22.8	0.3	0.15	7901UC
6.4	0.8	0.02	19.3	18.3	23.7	25.6	17.5	25.5	26.8	0.3	0.15	7902UC
6.7	0.8	0.02	21.3	20.3	25.7	27.8	19.5	27.5	28.8	0.3	0.15	7903UC
8.3	1.5	0.04	25.9	24.7	31.1	33.6	22.5	34.5	35.8	0.3	0.15	7904UC
9.0	1.8	0.04	30.9	29.7	36.1	38.6	27.5	39.5	40.8	0.3	0.15	7905UC
9.7	2.0	0.05	35.9	34.7	41.1	43.6	32.5	44.5	45.8	0.3	0.15	7906UC
11.1	3.4	0.07	41.6	39.9	48.4	51.7	39.5	50.5	52.5	0.6	0.3	7907UC
12.9	4.7	0.11	47.6	45.9	54.4	57.8	44.5	57.5	59.5	0.6	0.3	7908UC
13.6	5.9	0.12	52.7	50.8	60.4	64.0	49.5	63.5	65.5	0.6	0.3	7909UC
14.2	6.2	0.13	57.2	55.3	64.9	68.5	54.5	67.5	69.5	0.6	0.3	7910UC
15.6	7.5	0.18	63.7	61.8	71.4	75.1	60.5	74.5	75.5	1	0.6	7911UC
16.3	8.0	0.19	68.7	66.8	76.4	80.1	65.5	79.5	80.5	1	0.6	7912UC
16.9	8.6	0.21	73.7	71.8	81.4	85.1	70.5	84.5	85.5	1	0.6	7913UC
19.4	14	0.34	80.3	78.0	89.7	94.3	75.5	94.5	95.5	1	0.6	7914UC
20.1	15	0.36	85.3	83.0	94.7	99.3	80.5	99.5	100.5	1	0.6	7915UC
20.8	16	0.38	90.8	88.5	100.2	104.8	85.5	104.5	105.5	1	0.6	7916UC
22.8	22	0.54	96.9	94.3	108.1	113.5	92	113	115.5	1	0.6	7917UC
23.5	23	0.56	101.9	99.3	113.1	118.5	97	118	120.5	1	0.6	7918UC
24.1	24	0.59	106.9	104.3	118.1	123.5	102	123	125.5	1	0.6	7919UC
26.1	33	0.81	113.6	110.5	126.4	132.7	107	133	135.5	1	0.6	7920UC
26.8	34	0.84	118.6	115.5	131.4	137.7	112	138	140.5	1	0.6	7921UC
27.5	36	0.87	123.6	120.5	136.4	142.7	117	143	145.5	1	0.6	7922UC
30.2	48	1.19	135.2	131.7	149.8	156.8	127	158	160.5	1	0.6	7924UC
32.9	63	1.57	146.9	143.0	163.2	171.0	138.5	171.5	174.5	1.5	1	7926UC
34.2	67	1.66	156.0	—	174.1	180.5	148.5	181.5	184.5	1.5	1	7928CT1B
38.2	100	2.59	169.5	—	190.5	198.0	160	200	204.5	2	1	7930CT1B
39.6	106	2.72	179.5	—	200.6	208.0	170	210	214.5	2	1	7932CT1B
40.9	109	2.89	190.0	—	210.5	218.0	180	220	224.5	2	1	7934CT1B

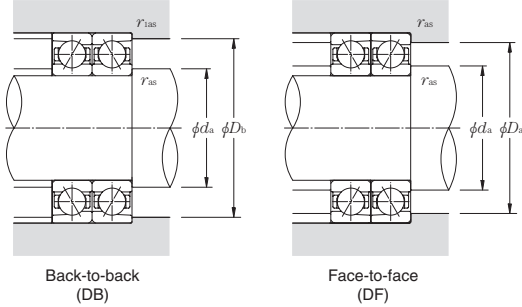
## ULTAGE Standard angular contact ball bearings (steel ball type) 79 series

Contact angle 25°  $d$  10~130mm



Part number	Boundary dimensions						Basic load ratings				Static axial load capacity		Limiting speed	
	mm						dynamic		static		kN	kgf	min <sup>-1</sup>	
	$d$	$D$	$B$	$r_{1s \min}$ ①	$r_{2s \min}$ ①	$C_r$	$C_{or}$	$C_r$	$C_{or}$	grease lubrication			oil lubrication	
7900UAD	10	22	6	0.3	0.15	3.05	1.58	310	161	1.77	180	63 400	102 500	
7901UAD	12	24	6	0.3	0.15	3.20	1.77	325	181	1.92	196	56 400	91 100	
7902UAD	15	28	7	0.3	0.15	4.85	2.77	495	283	2.81	287	47 200	76 300	
7903UAD	17	30	7	0.3	0.15	5.10	3.05	520	310	3.00	310	43 200	69 800	
7904UAD	20	37	9	0.3	0.15	7.25	4.65	740	475	4.70	480	35 600	57 500	
7905UAD	25	42	9	0.3	0.15	7.75	5.50	790	560	5.35	545	30 300	49 000	
7906UAD	30	47	9	0.3	0.15	8.15	6.30	830	640	6.00	610	26 400	42 600	
7907UAD	35	55	10	0.6	0.3	13.0	9.75	1 320	995	10.1	1 030	22 600	36 400	
7908UAD	40	62	12	0.6	0.3	13.7	11.2	1 400	1 140	11.3	1 160	19 900	32 200	
7909UAD	45	68	12	0.6	0.3	17.0	14.1	1 730	1 440	14.6	1 490	18 000	29 000	
7910UAD	50	72	12	0.6	0.3	17.9	15.8	1 820	1 610	16.2	1 650	16 600	26 900	
7911UAD	55	80	13	1	0.6	18.6	17.5	1 900	1 790	17.7	1 800	15 000	24 300	
7912UAD	60	85	13	1	0.6	19.4	19.1	1 970	1 950	19.2	1 960	14 000	22 600	
7913UAD	65	90	13	1	0.6	19.6	19.7	2 000	2 010	19.9	2 030	13 100	21 200	
7914UAD	70	100	16	1	0.6	28.0	28.6	2 860	2 920	27.9	2 840	11 900	19 300	
7915UAD	75	105	16	1	0.6	28.4	29.6	2 900	3 000	29.0	2 960	11 300	18 200	
7916UAD	80	110	16	1	0.6	28.7	30.5	2 930	3 100	30.0	3 050	10 600	17 200	
7917UAD	85	120	18	1.1	0.6	38.5	41.5	3 950	4 250	39.5	4 000	9 900	16 000	
7918UAD	90	125	18	1.1	0.6	39.5	43.0	4 000	4 400	41.0	4 200	9 400	15 300	
7919UAD	95	130	18	1.1	0.6	40.0	44.5	4 050	4 500	42.5	4 350	9 000	14 600	
7920UAD	100	140	20	1.1	0.6	51.0	57.5	5 200	5 850	56.0	5 750	8 500	13 700	
7921UAD	105	145	20	1.1	0.6	52.0	59.0	5 300	6 050	58.5	5 950	8 100	13 100	
7922UAD	110	150	20	1.1	0.6	52.5	61.0	5 400	6 250	60.5	6 150	7 800	12 600	
7924UAD	120	165	22	1.1	0.6	65.0	76.0	6 650	7 750	73.5	7 500	7 100	11 500	
7926UAD	130	180	24	1.5	1	80.0	95.0	8 150	9 700	94.0	9 550	6 600	10 600	

① Minimum allowable value for corner radius dimension  $r$  or  $r_1$ .



**Dynamic equivalent radial load**  $P_r = X F_r + Y F_a$

e	Single row / Tandem				Back-to-back / Face-to-face			
	$F_a / F_r \leq e$		$F_a / F_r > e$		$F_a / F_r \leq e$		$F_a / F_r > e$	
	X	Y	X	Y	X	Y	X	Y
0.68	1	0	0.41	0.87	1	0.92	0.67	1.41

**Static equivalent radial load**  $P_{or} = X_0 F_r + Y_0 F_a$

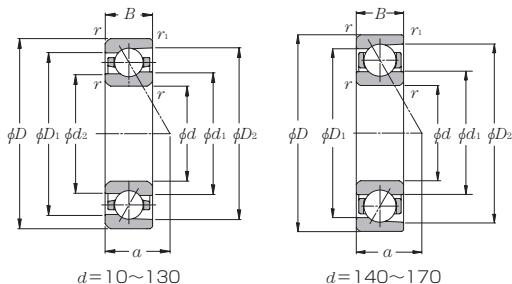
Single row / Tandem		Back-to-back / Face-to-face	
$X_0$	$Y_0$	$X_0$	$Y_0$
0.5	0.38	1	0.76

When  $P_{or} < F_r$  with single-row or tandem arrangement,  $P_{or} = F_r$ .

Load center mm	Internal free space cm <sup>3</sup>	Mass kg	Reference dimensions				Abutment and fillet dimensions					Part number
			mm				mm					
			$d_1$	$d_2$	$D_1$	$D_2$	$d_a$ min	$D_a$ max	$D_b$ max	$r_{as}$ max	$r_{1as}$ max	
6.8	0.4	0.01	14.3	13.5	17.7	19.4	12.5	19.5	20.8	0.3	0.15	7900UAD
7.2	0.4	0.01	16.3	15.5	19.7	21.3	14.5	21.5	22.8	0.3	0.15	7901UAD
8.6	0.8	0.02	19.3	18.3	23.7	25.7	17.5	25.5	26.8	0.3	0.15	7902UAD
9.0	0.8	0.02	21.3	20.3	25.7	27.7	19.5	27.5	28.8	0.3	0.15	7903UAD
11.2	1.5	0.04	25.9	24.7	31.1	33.6	22.5	34.5	35.8	0.3	0.15	7904UAD
12.4	1.8	0.04	30.9	29.7	36.1	38.6	27.5	39.5	40.8	0.3	0.15	7905UAD
13.5	2.0	0.05	35.9	34.7	41.1	43.6	32.5	44.5	45.8	0.3	0.15	7906UAD
15.6	3.4	0.07	41.6	39.9	48.4	51.7	39.5	50.5	52.5	0.6	0.3	7907UAD
18.0	4.7	0.11	47.6	45.9	54.4	57.7	44.5	57.5	59.5	0.6	0.3	7908UAD
19.2	5.9	0.12	52.7	50.8	60.4	64.0	49.5	63.5	65.5	0.6	0.3	7909UAD
20.3	6.2	0.13	57.2	55.3	64.9	68.5	54.5	67.5	69.5	0.6	0.3	7910UAD
22.3	7.5	0.18	63.7	61.8	71.4	75.1	60.5	74.5	75.5	1	0.6	7911UAD
23.5	8.0	0.19	68.7	66.8	76.4	80.0	65.5	79.5	80.5	1	0.6	7912UAD
24.6	8.6	0.21	73.7	71.8	81.4	85.0	70.5	84.5	85.5	1	0.6	7913UAD
27.9	14	0.34	80.3	78.0	89.7	94.3	75.5	94.5	95.5	1	0.6	7914UAD
29.1	15	0.36	85.3	83.0	94.7	99.3	80.5	99.5	100.5	1	0.6	7915UAD
30.4	16	0.38	90.8	88.5	100.2	104.7	85.5	104.5	105.5	1	0.6	7916UAD
33.0	22	0.54	96.9	94.3	108.1	113.5	92	113	115.5	1	0.6	7917UAD
34.2	23	0.56	101.9	99.3	113.1	118.5	97	118	120.5	1	0.6	7918UAD
35.3	24	0.59	106.9	104.3	118.1	123.4	102	123	125.5	1	0.6	7919UAD
38.1	33	0.81	113.6	110.5	126.4	132.6	107	133	135.5	1	0.6	7920UAD
39.3	34	0.84	118.6	115.5	131.4	137.6	112	138	140.5	1	0.6	7921UAD
40.4	36	0.87	123.6	120.5	136.4	142.6	117	143	145.5	1	0.6	7922UAD
44.4	48	1.19	135.2	131.7	149.8	156.7	127	158	160.5	1	0.6	7924UAD
48.3	63	1.57	146.9	143.0	163.2	170.9	138.5	171.5	174.5	1.5	1	7926UAD

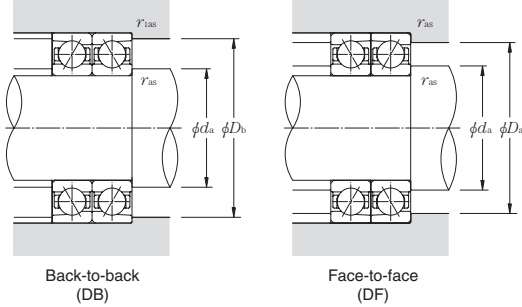
## ULTAGE Standard angular contact ball bearings (steel ball type) 79 series

Contact angle 30°  $d$  10~130mm



Part number	Boundary dimensions						Basic load ratings				Static axial load capacity		Limiting speed	
	mm						dynamic		static		kN	kgf	min <sup>-1</sup>	
	$d$	$D$	$B$	$r_{rs \min}$ ①	$r_{rs \max}$ ①	$C_r$	$C_{or}$	$C_r$	$C_{or}$	grease lubrication			oil lubrication	
7900U	10	22	6	0.3	0.15	2.95	1.53	300	156	1.36	139	53 700	73 200	
7901U	12	24	6	0.3	0.15	3.10	1.71	315	175	1.48	151	47 700	65 000	
7902U	15	28	7	0.3	0.15	4.70	2.68	480	274	2.14	218	40 000	54 500	
7903U	17	30	7	0.3	0.15	4.90	2.95	500	300	2.29	234	36 600	49 800	
7904U	20	37	9	0.3	0.15	7.00	4.50	715	460	3.60	365	30 100	41 100	
7905U	25	42	9	0.3	0.15	7.45	5.30	760	540	4.10	415	25 600	35 000	
7906U	30	47	9	0.3	0.15	7.80	6.05	800	615	4.60	465	22 300	30 400	
7907U	35	55	10	0.6	0.3	12.5	9.40	1 270	960	7.85	800	19 100	26 000	
7908U	40	62	12	0.6	0.3	13.1	10.7	1 340	1 100	8.75	895	16 900	23 000	
7909U	45	68	12	0.6	0.3	16.3	13.6	1 660	1 380	11.4	1 160	15 200	20 700	
7910U	50	72	12	0.6	0.3	17.2	15.2	1 750	1 550	12.6	1 280	14 100	19 200	
7911U	55	80	13	1	0.6	17.8	16.8	1 820	1 720	13.8	1 410	12 700	17 400	
7912U	60	85	13	1	0.6	18.6	18.2	1 890	1 850	15.0	1 530	11 900	16 200	
7913U	65	90	13	1	0.6	18.8	18.8	1 910	1 910	15.6	1 590	11 100	15 100	
7914U	70	100	16	1	0.6	26.9	27.3	2 740	2 780	21.5	2 190	10 100	13 800	
7915U	75	105	16	1	0.6	27.2	28.2	2 780	2 870	22.3	2 280	9 600	13 000	
7916U	80	110	16	1	0.6	27.5	29.1	2 810	2 970	23.2	2 370	9 000	12 300	
7917U	85	120	18	1.1	0.6	37.0	39.5	3 800	4 050	30.5	3 100	8 400	11 400	
7918U	90	125	18	1.1	0.6	37.5	41.0	3 850	4 150	31.5	3 200	8 000	10 900	
7919U	95	130	18	1.1	0.6	38.0	42.0	3 900	4 300	32.5	3 350	7 600	10 400	
7920U	100	140	20	1.1	0.6	49.0	54.5	5 000	5 550	43.5	4 450	7 200	9 800	
7921U	105	145	20	1.1	0.6	50.0	56.5	5 100	5 750	45.0	4 600	6 900	9 400	
7922U	110	150	20	1.1	0.6	50.5	58.0	5 150	5 900	46.5	4 750	6 600	9 000	
7924U	120	165	22	1.1	0.6	62.5	72.5	6 350	7 350	56.5	5 750	6 000	8 200	
7926U	130	180	24	1.5	1	76.5	90.5	7 800	9 250	72.5	7 400	5 500	7 600	

① Minimum allowable value for corner radius dimension  $r$  or  $r_1$ .



**Dynamic equivalent radial load**  $P_r = XF_r + YF_a$

e	Single row / Tandem				Back-to-back / Face-to-face			
	$F_a / F_r \leq e$		$F_a / F_r > e$		$F_a / F_r \leq e$		$F_a / F_r > e$	
	X	Y	X	Y	X	Y	X	Y
0.8	1	0	0.39	0.76	1	0.78	0.63	1.24

**Static equivalent radial load**  $P_{or} = X_0 F_r + Y_0 F_a$

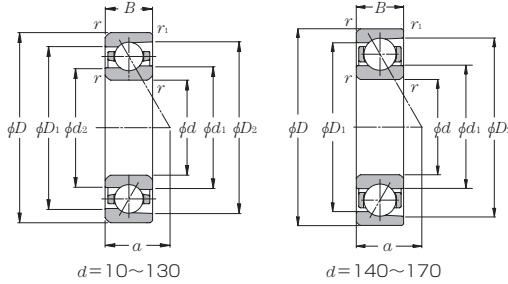
Single row / Tandem		Back-to-back / Face-to-face	
$X_0$	$Y_0$	$X_0$	$Y_0$
0.5	0.33	1	0.66

When  $P_{or} < F_r$  with single-row or tandem arrangement,  $P_{or} = F_r$ .

Load center mm	Internal free space cm <sup>3</sup> Single-row (approx.)	Mass kg Single-row (approx.)	Reference dimensions mm				Abutment and fillet dimensions mm					Part number
			$d_1$	$d_2$	$D_1$	$D_2$	$d_a$ min	$D_a$ max	$D_b$ max	$r_{as}$ max	$r_{1as}$ max	
7.7	0.4	0.01	14.3	13.5	17.7	19.3	12.5	19.5	20.8	0.3	0.15	7900U
8.2	0.4	0.01	16.3	15.5	19.7	21.3	14.5	21.5	22.8	0.3	0.15	7901U
9.8	0.8	0.02	19.3	18.3	23.7	25.6	17.5	25.5	26.8	0.3	0.15	7902U
10.3	0.8	0.02	21.3	20.3	25.7	27.7	19.5	27.5	28.8	0.3	0.15	7903U
12.8	1.5	0.04	25.9	24.7	31.1	33.5	22.5	34.5	35.8	0.3	0.15	7904U
14.2	1.8	0.04	30.9	29.7	36.1	38.5	27.5	39.5	40.8	0.3	0.15	7905U
15.7	2.0	0.05	35.9	34.7	41.1	43.5	32.5	44.5	45.8	0.3	0.15	7906U
18.1	3.4	0.07	41.6	39.9	48.4	51.6	39.5	50.5	52.5	0.6	0.3	7907U
20.8	4.7	0.11	47.6	45.9	54.4	57.7	44.5	57.5	59.5	0.6	0.3	7908U
22.4	5.9	0.12	52.7	50.8	60.4	64.0	49.5	63.5	65.5	0.6	0.3	7909U
23.7	6.2	0.13	57.2	55.3	64.9	68.4	54.5	67.5	69.5	0.6	0.3	7910U
26.1	7.5	0.18	63.7	61.8	71.4	75.0	60.5	74.5	75.5	1	0.6	7911U
27.5	8.0	0.19	68.7	66.8	76.4	80.0	65.5	79.5	80.5	1	0.6	7912U
29.0	8.6	0.21	73.7	71.8	81.4	85.0	70.5	84.5	85.5	1	0.6	7913U
32.6	14	0.34	80.3	78.0	89.7	94.2	75.5	94.5	95.5	1	0.6	7914U
34.1	15	0.36	85.3	83.0	94.7	99.2	80.5	99.5	100.5	1	0.6	7915U
35.7	16	0.38	90.8	88.5	100.2	104.7	85.5	104.5	105.5	1	0.6	7916U
38.7	22	0.54	96.9	94.3	108.1	113.4	92	113	115.5	1	0.6	7917U
40.2	23	0.56	101.9	99.3	113.1	118.4	97	118	120.5	1	0.6	7918U
41.6	24	0.59	106.9	104.3	118.1	123.4	102	123	125.5	1	0.6	7919U
44.8	33	0.81	113.6	110.5	126.4	132.6	107	133	135.5	1	0.6	7920U
46.2	34	0.84	118.6	115.5	131.4	137.6	112	138	140.5	1	0.6	7921U
47.7	36	0.87	123.6	120.5	136.4	142.6	117	143	145.5	1	0.6	7922U
52.3	48	1.19	135.2	131.7	149.8	156.7	127	158	160.5	1	0.6	7924U
56.9	63	1.57	146.9	143.0	163.2	170.9	138.5	171.5	174.5	1.5	1	7926U

## ULTAGE Standard angular contact ball bearings (steel ball type) 70 series

Contact angle 15°  $d = 10 \sim 200$ mm

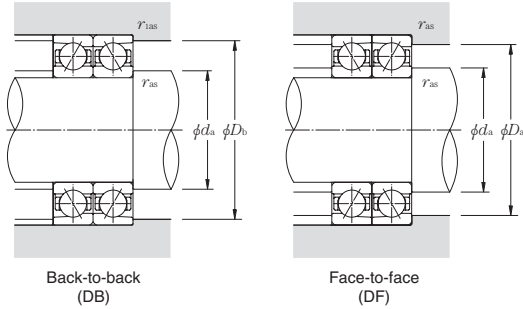


Part number	Boundary dimensions						Basic load ratings				Static axial load capacity		Factor	Limiting speed	
	mm						dynamic		static		kN	kgf		min <sup>-1</sup>	
	d	D	B	r <sub>s min</sub> <sup>①</sup>	r <sub>1s min</sub> <sup>①</sup>	C <sub>r</sub>	C <sub>or</sub>	C <sub>r</sub>	C <sub>or</sub>	grease lubrication				oil lubrication	
7000UC	10	26	8	0.3	0.15	5.30	2.48	540	253	3.80	390	12.6	65 800	105 300	
7001UC	12	28	8	0.3	0.15	5.80	2.93	595	299	4.25	435	13.4	57 100	91 400	
7002UC	15	32	9	0.3	0.15	6.60	3.70	675	375	5.15	525	14.1	49 900	79 800	
7003UC	17	35	10	0.3	0.15	8.25	4.55	840	460	6.60	670	13.8	45 100	72 100	
7004UC	20	42	12	0.6	0.3	11.1	6.6	1 130	670	9.60	980	14.1	37 200	59 500	
7005UC	25	47	12	0.6	0.3	12.3	8.0	1 250	815	11.3	1 150	14.7	32 500	52 100	
7006UC	30	55	13	1	0.6	15.8	11.0	1 620	1 120	15.4	1 570	14.9	27 200	43 600	
7007UC	35	62	14	1	0.6	20.0	14.6	2 040	1 490	19.5	1 990	15.0	24 200	38 700	
7008UC	40	68	15	1	0.6	21.4	16.8	2 180	1 720	22.0	2 250	15.4	21 700	34 700	
7009UC	45	75	16	1	0.6	25.3	20.4	2 580	2 080	27.1	2 770	15.4	19 500	31 200	
7010UC	50	80	16	1	0.6	26.9	23.1	2 740	2 350	30.0	3 100	15.7	18 000	28 800	
7011UC	55	90	18	1.1	0.6	35.5	30.0	3 600	3 100	39.0	4 000	15.5	16 200	25 900	
7012UC	60	95	18	1.1	0.6	36.5	32.5	3 700	3 300	41.5	4 200	15.7	15 100	24 200	
7013UC	65	100	18	1.1	0.6	38.5	36.0	3 900	3 650	45.5	4 650	15.9	14 200	22 700	
7014UC	70	110	20	1.1	0.6	48.5	45.0	4 950	4 600	59.0	6 050	15.7	13 000	20 800	
7015UC	75	115	20	1.1	0.6	49.5	48.0	5 050	4 900	62.0	6 350	15.9	12 300	19 700	
7016UC	80	125	22	1.1	0.6	60.5	58.0	6 200	5 900	74.5	7 600	15.7	11 400	18 300	
7017UC	85	130	22	1.1	0.6	62.0	61.5	6 350	6 250	78.5	8 000	15.9	10 900	17 400	
7018UC	90	140	24	1.5	1	74.0	72.5	7 550	7 400	95.0	9 700	15.7	10 200	16 300	
7019UC	95	145	24	1.5	1	76.0	76.5	7 750	7 800	100	10 200	15.9	9 800	15 600	
7020UC	100	150	24	1.5	1	77.5	81.0	7 900	8 250	104	10 600	16.0	9 400	15 000	
7021UC	105	160	26	2	1	91.0	93.5	9 250	9 550	120	12 300	15.9	8 800	14 100	
7022UC	110	170	28	2	1	104	106	10 600	10 900	140	14 200	15.7	8 400	13 400	
7024UC	120	180	28	2	1	106	113	10 800	11 500	147	14 900	16.0	7 800	12 500	
7026UC	130	200	33	2	1	133	144	13 600	14 700	186	19 000	15.9	7 100	11 400	
7028UC	140	210	33	2	1	136	152	13 900	15 500	193	19 700	16.0	6 700	10 700	
7030CT1B	150	225	35	2.1	1.1	151	168	15 400	17 200	210	21 500	16.0	6 000	9 500	
7032CT1B	160	240	38	2.1	1.1	171	193	17 400	19 700	230	23 500	16.0	5 500	8 500	
7034CT1B	170	260	42	2.1	1.1	205	234	20 900	23 900	260	26 500	15.9	5 000	7 500	
7036CT1B	180	280	46	2.1	1.1	241	290	24 500	29 600	300	30 500	15.7	4 500	6 500	
7038CT1B	190	290	46	2.1	1.1	247	305	25 100	31 500	310	31 500	15.9	4 200	6 000	
7040CT1B	200	310	51	2.1	1.1	277	355	28 200	36 000	350	35 500	15.7	3 800	5 500	

① Minimum allowable value for corner radius dimension  $r$  or  $r_1$ .

A part number containing a suffix **U** means an **ULTAGE Series**.





### Dynamic equivalent radial load

$$P_r = X F_r + Y F_a$$

$\frac{v_1^{10} F_{r1}}{C_{Or}}$	$e$	Single row / Tandem				Back-to-back / Face-to-face			
		$F_{a1} F_r \leq e$		$F_{a1} F_r > e$		$F_{a1} F_r \leq e$		$F_{a1} F_r > e$	
		X	Y	X	Y	X	Y	X	Y
0.178	0.38			1.47		1.65		2.39	
0.357	0.4			1.4		1.57		2.28	
0.714	0.43			1.3		1.46		2.11	
1.07	0.46			1.23		1.38		2	
1.43	0.47	1	0	1.19	1	1.34	0.72	1.93	
2.14	0.5			1.12		1.26		1.82	
3.57	0.55			1.02		1.14		1.66	
5.35	0.56			1		1.12		1.63	
7.14	0.56			1		1.12		1.63	

### Static equivalent radial load

$$P_{Or} = X_0 F_r + Y_0 F_a$$

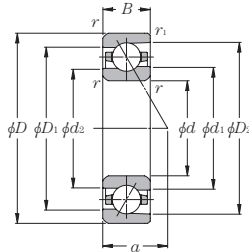
Single row / Tandem		Back-to-back / Face-to-face	
$X_0$	$Y_0$	$X_0$	$Y_0$
0.5	0.46	1	0.92

When  $P_{Or} < P_r$  with single-row or tandem arrangement,  $P_{Or} = P_r$ .

Load center mm	Internal free space cm <sup>3</sup>	Mass kg	Reference dimensions				Abutment and fillet dimensions					Part number
			mm				mm					
<i>a</i>	Single-row (approx.)	Single-row (approx.)	<i>d</i> <sub>1</sub>	<i>d</i> <sub>2</sub>	<i>D</i> <sub>1</sub>	<i>D</i> <sub>2</sub>	<i>d</i> <sub>a</sub> min	<i>D</i> <sub>a</sub> max	<i>D</i> <sub>b</sub> max	<i>r</i> <sub>as</sub> max	<i>r</i> <sub>1as</sub> max	
6.4	0.9	0.019	15.2	14.0	20.4	22.7	12.5	23.5	24.8	0.3	0.15	7000UC
6.8	1.0	0.021	17.9	16.7	23.1	25.6	14.5	25.5	26.8	0.3	0.15	7001UC
7.7	1.3	0.030	20.9	19.7	26.1	28.5	17.5	29.5	30.8	0.3	0.15	7002UC
8.5	1.8	0.037	23.0	21.6	29.0	32.0	19.5	32.5	33.8	0.3	0.15	7003UC
10.3	2.9	0.067	28.1	26.4	34.9	38.4	24.5	37.5	39.5	0.6	0.3	7004UC
10.9	3.3	0.079	32.6	30.9	39.4	42.9	29.5	42.5	44.5	0.6	0.3	7005UC
12.3	4.8	0.11	39.2	37.3	46.9	50.7	35.5	49.5	50.5	1	0.6	7006UC
13.5	6.3	0.15	44.2	42.2	52.8	57.0	40.5	56.5	57.5	1	0.6	7007UC
14.8	7.4	0.19	49.7	47.7	58.3	62.5	45.5	62.5	63.5	1	0.6	7008UC
16.1	9.4	0.24	55.3	53.0	64.7	69.4	50.5	69.5	70.5	1	0.6	7009UC
16.8	11	0.26	60.3	58.0	69.7	74.4	55.5	74.5	75.5	1	0.6	7010UC
18.8	16	0.38	66.9	64.3	78.1	83.6	62	83	85.5	1	0.6	7011UC
19.4	17	0.41	71.9	69.3	83.1	88.6	67	88	90.5	1	0.6	7012UC
20.1	18	0.44	76.9	74.3	88.1	93.5	72	93	95.5	1	0.6	7013UC
22.1	24	0.61	83.6	80.5	96.4	102.7	77	103	105.5	1	0.6	7014UC
22.8	26	0.64	88.6	85.5	101.4	107.7	82	108	110.5	1	0.6	7015UC
24.8	34	0.86	95.2	91.7	109.8	116.9	87	118	120.5	1	0.6	7016UC
25.5	36	0.90	100.2	96.7	114.8	121.9	92	123	125.5	1	0.6	7017UC
27.5	47	1.17	106.9	103.0	123.2	131.1	98.5	131.5	134.5	1.5	1	7018UC
28.2	49	1.22	111.9	108.0	128.2	136.1	103.5	136.5	139.5	1.5	1	7019UC
28.8	51	1.27	116.9	113.0	133.2	141.1	108.5	141.5	144.5	1.5	1	7020UC
30.8	70	1.58	123.5	119.2	141.5	150.2	115	150	154.5	2	1	7021UC
32.9	83	1.98	130.2	125.4	149.9	159.4	120	160	164.5	2	1	7022UC
34.2	90	2.11	140.2	135.4	159.9	169.4	130	170	174.5	2	1	7024UC
38.7	131	3.25	153.9	148.5	176.2	187.1	140	190	194.5	2	1	7026UC
40.1	144	3.38	164.0	158.7	186.3	197.1	150	200	204.5	2	1	7028UC
42.7	166	4.19	174.2	—	200.8	210.5	162	213	218	2	1	7030CT1B
45.9	214	5.14	185.5	—	214.5	224.6	172	228	233	2	1	7032CT1B
49.9	278	6.94	199.0	—	231.0	242.9	182	248	253	2	1	7034CT1B
53.9	360	9.12	212.0	—	248.0	261.2	192	268	273	2	1	7036CT1B
55.2	375	9.53	222.0	—	258.0	271.2	202	278	283	2	1	7038CT1B
59.8	492	12.3	235.0	—	275.0	289.5	212	298	303	2	1	7040CT1B

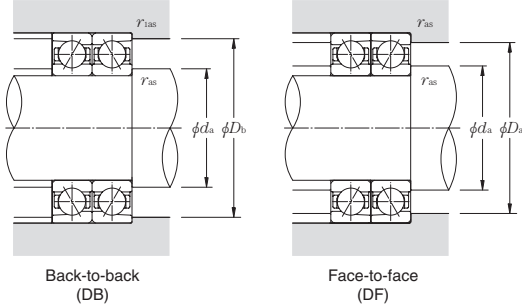
## ULTAGE Standard angular contact ball bearings (steel ball type) 70 series

Contact angle 25°  $d$  10~130mm



Part number	Boundary dimensions						Basic load ratings				Static axial load capacity		Limiting speed	
	mm						dynamic	static	dynamic	static	kN	kgf	min <sup>-1</sup>	
	$d$	$D$	$B$	$r_{s \min}$ ①	$r_{1s \min}$ ②	$C_r$	$C_{or}$	$C_r$	$C_{or}$	grease lubrication			oil lubrication	
7000UAD	10	26	8	0.3	0.15	5.15	2.40	525	244	2.77	283	57 000	92 100	
7001UAD	12	28	8	0.3	0.15	5.60	2.82	570	287	3.10	315	49 500	80 000	
7002UAD	15	32	9	0.3	0.15	6.35	3.55	645	360	3.75	380	43 200	69 800	
7003UAD	17	35	10	0.3	0.15	7.90	4.35	805	445	4.85	495	39 000	63 100	
7004UAD	20	42	12	0.6	0.3	10.6	6.30	1 080	645	7.10	720	32 200	52 100	
7005UAD	25	47	12	0.6	0.3	11.7	7.65	1 190	780	8.30	845	28 200	45 600	
7006UAD	30	55	13	1	0.6	15.1	10.5	1 540	1 070	11.5	1 170	23 600	38 100	
7007UAD	35	62	14	1	0.6	19.0	13.9	1 940	1 420	14.3	1 460	20 900	33 800	
7008UAD	40	68	15	1	0.6	20.3	16.0	2 070	1 630	16.1	1 650	18 800	30 400	
7009UAD	45	75	16	1	0.6	24.0	19.4	2 450	1 980	19.9	2 030	16 900	27 300	
7010UAD	50	80	16	1	0.6	25.5	21.9	2 600	2 230	22.2	2 260	15 600	25 200	
7011UAD	55	90	18	1.1	0.6	33.5	28.7	3 400	2 930	28.6	2 920	14 000	22 600	
7012UAD	60	95	18	1.1	0.6	34.5	30.5	3 500	3 150	30.0	3 100	13 100	21 200	
7013UAD	65	100	18	1.1	0.6	36.0	34.0	3 700	3 500	33.5	3 400	12 300	19 900	
7014UAD	70	110	20	1.1	0.6	46.0	43.0	4 700	4 350	43.5	4 450	11 300	18 200	
7015UAD	75	115	20	1.1	0.6	47.0	45.5	4 800	4 650	45.5	4 650	10 700	17 300	
7016UAD	80	125	22	1.1	0.6	57.5	55.0	5 850	5 600	55.0	5 600	9 900	16 000	
7017UAD	85	130	22	1.1	0.6	58.5	58.5	6 000	5 950	57.5	5 850	9 400	15 300	
7018UAD	90	140	24	1.5	1	70.0	69.0	7 150	7 050	70.0	7 150	8 800	14 300	
7019UAD	95	145	24	1.5	1	71.5	73.0	7 300	7 400	73.5	7 500	8 500	13 700	
7020UAD	100	150	24	1.5	1	73.5	76.5	7 500	7 800	77.0	7 850	8 100	13 100	
7021UAD	105	160	26	2	1	86.0	89.0	8 750	9 050	88.0	9 000	7 700	12 400	
7022UAD	110	170	28	2	1	98.5	101	10 100	10 300	103	10 500	7 300	11 700	
7024UAD	120	180	28	2	1	101	107	10 300	10 900	108	11 000	6 800	10 900	
7026UAD	130	200	33	2	1	126	136	12 900	13 900	137	14 000	6 200	9 900	
7028UAD	140	210	33	2	1	128	144	13 100	14 700	141	14 400	5 800	9300	

① Minimum allowable value for corner radius dimension  $r$  or  $r_1$ .



**Dynamic equivalent radial load**  $P_r = X F_r + Y F_a$

e	Single row / Tandem				Back-to-back / Face-to-face			
	$F_a / F_r \leq e$		$F_a / F_r > e$		$F_a / F_r \leq e$		$F_a / F_r > e$	
	X	Y	X	Y	X	Y	X	Y
0.68	1	0	0.41	0.87	1	0.92	0.67	1.41

**Static equivalent radial load**  $P_{or} = X_0 F_r + Y_0 F_a$

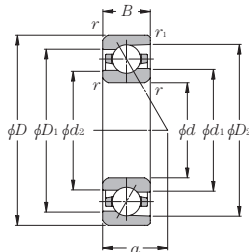
Single row / Tandem		Back-to-back / Face-to-face	
$X_0$	$Y_0$	$X_0$	$Y_0$
0.5	0.38	1	0.76

When  $P_{or} < F_r$  with single-row or tandem arrangement,  $P_{or} = F_r$ .

Load center mm	Internal free space cm <sup>3</sup> Single-row (approx.)	Mass kg Single-row (approx.)	Reference dimensions mm				Abutment and fillet dimensions mm					Part number
			$d_1$	$d_2$	$D_1$	$D_2$	$d_a$ min	$D_a$ max	$D_b$ max	$r_{as}$ max	$r_{1as}$ max	
8.2	0.9	0.019	15.2	14.0	20.4	22.9	12.5	23.5	24.8	0.3	0.15	7000UAD
8.8	1.0	0.021	17.9	16.7	23.1	25.6	14.5	25.5	26.8	0.3	0.15	7001UAD
10.0	1.3	0.030	20.9	19.7	26.1	28.6	17.5	29.5	30.8	0.3	0.15	7002UAD
11.1	1.8	0.037	23.0	21.6	29.0	32.0	19.5	32.5	33.8	0.3	0.15	7003UAD
13.4	2.9	0.067	28.1	26.4	34.9	38.3	24.5	37.5	39.5	0.6	0.3	7004UAD
14.5	3.3	0.079	32.6	30.9	39.4	42.8	29.5	42.5	44.5	0.6	0.3	7005UAD
16.6	4.8	0.11	39.2	37.3	46.9	50.7	35.5	49.5	50.5	1	0.6	7006UAD
18.4	6.3	0.15	44.2	42.2	52.8	56.9	40.5	56.5	57.5	1	0.6	7007UAD
20.2	7.4	0.19	49.7	47.7	58.3	62.5	45.5	62.5	63.5	1	0.6	7008UAD
22.1	9.4	0.24	55.3	53.0	64.7	69.3	50.5	69.5	70.5	1	0.6	7009UAD
23.2	11	0.26	60.3	58.0	69.7	74.3	55.5	74.5	75.5	1	0.6	7010UAD
26.0	16	0.38	66.9	64.3	78.1	83.5	62	83	85.5	1	0.6	7011UAD
27.2	17	0.41	71.9	69.3	83.1	88.5	67	88	90.5	1	0.6	7012UAD
28.3	18	0.44	76.9	74.3	88.1	93.5	72	93	95.5	1	0.6	7013UAD
31.1	24	0.61	83.6	80.5	96.4	102.7	77	103	105.5	1	0.6	7014UAD
32.3	26	0.64	88.6	85.5	101.4	107.7	82	108	110.5	1	0.6	7015UAD
35.0	34	0.86	95.2	91.7	109.8	116.9	87	118	120.5	1	0.6	7016UAD
36.2	36	0.90	100.2	96.7	114.8	121.9	92	123	125.5	1	0.6	7017UAD
39.0	47	1.17	106.9	103.0	123.2	131.0	98.5	131.5	134.5	1.5	1	7018UAD
40.1	49	1.22	111.9	108.0	128.2	136.0	103.5	136.5	139.5	1.5	1	7019UAD
41.3	51	1.27	116.9	113.0	133.2	141.0	108.5	141.5	144.5	1.5	1	7020UAD
44.1	70	1.58	123.5	119.2	141.5	150.2	115	150	154.5	2	1	7021UAD
46.8	83	1.98	130.2	125.4	149.9	159.3	120	160	164.5	2	1	7022UAD
49.2	90	2.11	140.2	135.4	159.9	169.3	130	170	174.5	2	1	7024UAD
55.2	131	3.25	153.9	148.5	176.2	187.0	140	190	194.5	2	1	7026UAD
57.5	144	3.38	164.0	158.7	186.3	197.0	150	200	204.5	2	1	7028UAD

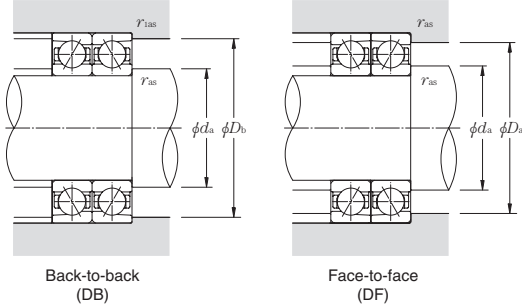
## ULTAGE Standard angular contact ball bearings (steel ball type) 70 series

Contact angle 30°  $d$  10~130mm



Part number	Boundary dimensions						Basic load ratings				Static axial load capacity		Limiting speed	
	mm						dynamic		static		kN	kgf	min <sup>-1</sup>	
	$d$	$D$	$B$	$r_{s \min}$ ①	$r_{1s \min}$ ①	$C_r$	$C_{or}$	$C_r$	$C_{or}$	grease lubrication			oil lubrication	
7000U	10	26	8	0.3	0.15	5.00	2.33	510	238	2.12	216	48 200	65 700	
7001U	12	28	8	0.3	0.15	5.45	2.74	555	279	2.37	242	41 900	57 100	
7002U	15	32	9	0.3	0.15	6.15	3.45	625	350	2.86	292	36 600	49 800	
7003U	17	35	10	0.3	0.15	7.65	4.20	780	430	3.70	380	33 000	45 000	
7004U	20	42	12	0.6	0.3	10.3	6.10	1 050	620	5.45	560	27 300	37 200	
7005U	25	47	12	0.6	0.3	11.3	7.40	1 150	755	6.40	655	23 900	32 500	
7006U	30	55	13	1	0.6	14.5	10.2	1 480	1 040	8.90	910	20 000	27 200	
7007U	35	62	14	1	0.6	18.3	13.4	1 870	1 370	11.0	1 120	17 700	24 100	
7008U	40	68	15	1	0.6	19.5	15.4	1 990	1 570	12.4	1 260	15 900	21 700	
7009U	45	75	16	1	0.6	23.1	18.7	2 360	1 910	15.4	1 570	14 300	19 500	
7010U	50	80	16	1	0.6	24.5	21.1	2 500	2 150	17.1	1 740	13 200	18 000	
7011U	55	90	18	1.1	0.6	32.5	27.7	3 300	2 830	22.0	2 240	11 900	16 200	
7012U	60	95	18	1.1	0.6	33.0	29.5	3 350	3 000	23.2	2 360	11 100	15 100	
7013U	65	100	18	1.1	0.6	35.0	33.0	3 550	3 350	25.5	2 600	10 400	14 200	
7014U	70	110	20	1.1	0.6	44.0	41.5	4 500	4 200	33.5	3 450	9 500	13 000	
7015U	75	115	20	1.1	0.6	45.0	43.5	4 600	4 450	35.0	3 600	9 000	12 300	
7016U	80	125	22	1.1	0.6	55.0	53.0	5 600	5 400	42.0	4 300	8 400	11 400	
7017U	85	130	22	1.1	0.6	56.5	56.0	5 750	5 700	44.0	4 500	8 000	10 900	
7018U	90	140	24	1.5	1	67.5	66.5	6 850	6 750	54.0	5 500	7 500	10 200	
7019U	95	145	24	1.5	1	69.0	70.0	7 050	7 150	56.5	5 800	7 200	9 800	
7020U	100	150	24	1.5	1	70.5	74.0	7 200	7 500	59.5	6 050	6 900	9 400	
7021U	105	160	26	2	1	82.5	85.5	8 400	8 750	68.0	6 900	6 500	8 800	
7022U	110	170	28	2	1	95.0	97.5	9 650	9 950	79.5	8 100	6 100	8 400	
7024U	120	180	28	2	1	96.5	103	9 850	10 500	83.5	8 500	5 700	7 800	
7026U	130	200	33	2	1	121	131	12 300	13 400	106	10 800	5 200	7 100	
7028U	140	210	33	2	1	123	139	12 600	14 100	109	11 100	4 900	6 700	

① Minimum allowable value for corner radius dimension  $r$  or  $r_1$ .



**Dynamic equivalent radial load**  $P_r = X F_r + Y F_a$

e	Single row / Tandem		Back-to-back / Face-to-face					
	$F_a / F_r \leq e$		$F_a / F_r > e$		$F_a / F_r \leq e$		$F_a / F_r > e$	
	X	Y	X	Y	X	Y	X	Y
0.8	1	0	0.39	0.76	1	0.78	0.63	1.24

**Static equivalent radial load**  $P_{0r} = X_0 F_r + Y_0 F_a$

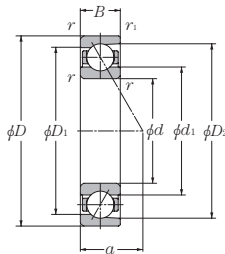
Single row / Tandem		Back-to-back / Face-to-face	
$X_0$	$Y_0$	$X_0$	$Y_0$
0.5	0.33	1	0.66

When  $P_{0r} < F_r$  with single-row or tandem arrangement,  $P_{0r} = F_r$ .

Load center mm	Internal free space cm <sup>3</sup> Single-row (approx.)	Mass kg Single-row (approx.)	Reference dimensions mm				Abutment and fillet dimensions mm					Part number
			$d_1$	$d_2$	$D_1$	$D_2$	$d_a$ min	$D_a$ max	$D_b$ max	$r_{as}$ max	$r_{1as}$ max	
9.2	0.9	0.019	15.2	14.0	20.4	22.7	12.5	23.5	24.8	0.3	0.15	7000U
10.0	1.0	0.021	17.9	16.7	23.1	25.5	14.5	25.5	26.8	0.3	0.15	7001U
11.3	1.3	0.030	20.9	19.7	26.1	28.6	17.5	29.5	30.8	0.3	0.15	7002U
12.6	1.8	0.037	23.0	21.6	29.0	31.9	19.5	32.5	33.8	0.3	0.15	7003U
15.2	2.9	0.067	28.1	26.4	34.9	38.3	24.5	37.5	39.5	0.6	0.3	7004U
16.5	3.3	0.079	32.6	30.9	39.4	42.8	29.5	42.5	44.5	0.6	0.3	7005U
19.0	4.8	0.11	39.2	37.3	46.9	50.6	35.5	49.5	50.5	1	0.6	7006U
21.1	6.3	0.15	44.2	42.2	52.8	56.9	40.5	56.5	57.5	1	0.6	7007U
23.2	7.4	0.19	49.7	47.7	58.3	62.4	45.5	62.5	63.5	1	0.6	7008U
25.4	9.4	0.24	55.3	53.0	64.7	69.3	50.5	69.5	70.5	1	0.6	7009U
26.9	11	0.26	60.3	58.0	69.7	74.3	55.5	74.5	75.5	1	0.6	7010U
30.1	16	0.38	66.9	64.3	78.1	83.5	62	83	85.5	1	0.6	7011U
31.5	17	0.41	71.9	69.3	83.1	88.5	67	88	90.5	1	0.6	7012U
32.9	18	0.44	76.9	74.3	88.1	93.4	72	93	95.5	1	0.6	7013U
36.1	24	0.61	83.6	80.5	96.4	102.6	77	103	105.5	1	0.6	7014U
37.6	26	0.64	88.6	85.5	101.4	107.6	82	108	110.5	1	0.6	7015U
40.8	34	0.86	95.2	91.7	109.8	116.8	87	118	120.5	1	0.6	7016U
42.2	36	0.90	100.2	96.7	114.8	121.8	92	123	125.5	1	0.6	7017U
45.4	47	1.17	106.9	103.0	123.2	131.0	98.5	131.5	134.5	1.5	1	7018U
46.8	49	1.22	111.9	108.0	128.2	136.0	103.5	136.5	139.5	1.5	1	7019U
48.3	51	1.27	116.9	113.0	133.2	141.0	108.5	141.5	144.5	1.5	1	7020U
51.5	70	1.58	123.5	119.2	141.5	150.1	115	150	154.5	2	1	7021U
54.6	83	1.98	130.2	125.4	149.9	159.3	120	160	164.5	2	1	7022U
57.5	90	2.11	140.2	135.4	159.9	169.2	130	170	174.5	2	1	7024U
64.4	131	3.25	153.9	148.5	176.2	186.9	140	190	194.5	2	1	7026U
67.3	144	3.38	164.0	158.7	186.3	197.0	150	200	204.5	2	1	7028U

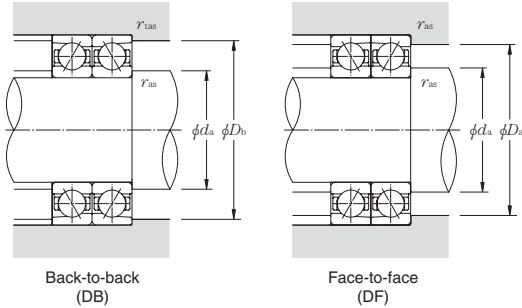
## Standard angular contact ball bearings (steel ball type) 72 series

Contact angle 15°  $d$  10~130mm



Part number	Boundary dimensions						Basic load ratings				Static axial load capacity		Factor	Limiting speed		
	mm						dynamic	static	dynamic	static	kN	kgf		$f_0$	grease	oil
	$d$	$D$	$B$	$r_{3\text{ min}}$ ①	$r_{18\text{ min}}$ ①		$C_r$	$C_{or}$	$C_r$	$C_{or}$					min <sup>-1</sup>	lubrication
7200C	10	30	9	0.6	0.3		5.40	2.64	555	269	1.01	103	13.4	42 900	55 600	
7201C	12	32	10	0.6	0.3		7.10	3.45	720	355	1.59	162	12.9	40 000	51 800	
7202C	15	35	11	0.6	0.3		9.00	4.50	915	460	1.89	193	12.9	35 200	45 600	
7203C	17	40	12	0.6	0.3		11.2	5.75	1 140	590	2.67	272	13.0	30 500	39 600	
7204C	20	47	14	1	0.6		14.6	8.15	1 490	835	3.70	375	13.4	25 500	33 000	
7205C	25	52	15	1	0.6		16.6	10.2	1 690	1 050	3.75	385	14.0	22 600	29 200	
7206C	30	62	16	1	0.6		23.0	14.7	2 350	1 500	7.10	725	14.0	18 900	24 500	
7207C	35	72	17	1.1	0.6		30.5	19.9	3 100	2 030	10.6	1 090	13.9	16 400	21 300	
7208C	40	80	18	1.1	0.6		36.5	25.2	3 700	2 570	14.4	1 470	14.2	14 700	19 000	
7209C	45	85	19	1.1	0.6		41.0	28.8	4 150	2 940	14.8	1 510	14.2	13 500	17 500	
7210C	50	90	20	1.1	0.6		43.0	31.5	4 350	3 250	15.3	1 560	14.5	12 600	16 300	
7211C	55	100	21	1.5	1		53.0	40.0	5 400	4 100	21.6	2 200	14.5	11 400	14 700	
7212C	60	110	22	1.5	1		64.0	49.5	6 550	5 050	26.1	2 660	14.5	10 200	13 200	
7213C	65	120	23	1.5	1		70.0	55.0	7 100	5 600	28.5	2 910	14.6	9 500	12 300	
7214C	70	125	24	1.5	1		76.0	60.0	7 750	6 150	31.0	3 150	14.6	9 000	11 700	
7215C	75	130	25	1.5	1		79.5	65.5	8 100	6 700	33.5	3 400	14.8	8 500	11 000	
7216C	80	140	26	2	1		93.0	77.5	9 450	7 900	34.5	3 550	14.7	8 000	10 400	
7217C	85	150	28	2	1		104	90.5	10 600	9 200	46.5	4 750	14.9	7 500	9 700	
7218C	90	160	30	2	1		123	105	12 500	10 700	53.5	5 450	14.6	7 000	9 100	
7219C	95	170	32	2.1	1.1		139	120	14 200	12 200	62.0	6 350	14.6	6 600	8 600	
7220C	100	180	34	2.1	1.1		149	127	15 200	12 900	67.0	6 800	14.5	6 300	8 100	
7221CT1B	105	190	36	2.1	1.1		162	143	16 600	14 600	74.5	7 600	14.5	6 000	7 700	
7222CT1B	110	200	38	2.1	1.1		176	160	17 900	16 300	86.0	8 800	14.5	5 700	7 400	
7224CT1B	120	215	40	2.1	1.1		199	192	20 200	19 600	91.5	9 300	14.6	5 300	6 800	
7226CT1B	130	230	40	3	1.1		213	214	21 700	21 800	111	11 300	14.7	4 900	6 300	

① Minimum allowable value for corner radius dimension  $r$  or  $r_1$ .



**Dynamic equivalent radial load**

$$P_r = X F_r + Y F_a$$

$i \cdot f_0 \cdot F_a / C_{Or}$	e	Single row / Tandem				Back-to-back / Face-to-face			
		$F_d / F_r \leq e$		$F_d / F_r > e$		$F_d / F_r \leq e$		$F_d / F_r > e$	
		X	Y	X	Y	X	Y	X	Y
0.173	0.38			1.47		1.65		2.39	
0.357	0.4			1.4		1.57		2.28	
0.714	0.43			1.3		1.46		2.11	
1.07	0.46			1.23		1.38		2	
1.43	0.47	1	0	1.19	1	1.34	0.72	1.93	
2.14	0.5			1.12		1.26		1.82	
3.57	0.55			1.02		1.14		1.66	
5.35	0.56			1		1.12		1.63	
7.14	0.56			1		1.12		1.63	

**Static equivalent radial load**

$$P_{Or} = X_0 F_r + Y_0 F_a$$

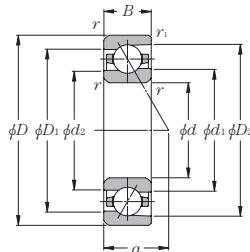
Single row / Tandem		Back-to-back / Face-to-face	
$X_0$	$Y_0$	$X_0$	$Y_0$
0.5	0.46	1	0.92

When  $P_{Or} < P_r$  with single-row or tandem arrangement,  $P_{Or} = P_r$ .

Load center mm	Internal free space cm <sup>3</sup>	Mass kg	Reference dimensions			Abutment and fillet dimensions					Part number
			mm			mm					
a	Single-row (approx.)	Single-row (approx.)	d <sub>1</sub>	D <sub>1</sub>	D <sub>2</sub>	d <sub>a</sub> min	D <sub>a</sub> max	D <sub>b</sub> max	r <sub>as</sub> max	r <sub>1as</sub> max	
7.3	0.9	0.029	17.4	23.5	25.5	14.5	25.5	27.5	0.6	0.3	7200C
8.0	1.3	0.036	18.4	25.6	27.8	16.5	27.5	29.5	0.6	0.3	7201C
8.9	1.5	0.045	20.8	29.0	31.6	19.5	30.5	32.5	0.6	0.3	7202C
9.9	2.1	0.062	24.2	33.2	36.2	21.5	35.5	37.5	0.6	0.3	7203C
11.6	3.1	0.10	29.4	39.4	42.8	25.5	41.5	42.5	1	0.6	7204C
12.7	4.1	0.12	33.8	44.2	47.3	30.5	46.5	47.5	1	0.6	7205C
14.3	6.6	0.19	40.6	52.2	56.4	35.5	56.5	57.5	1	0.6	7206C
15.7	8.8	0.27	46.8	60.2	65.0	42	65	67.5	1	0.6	7207C
17.1	11	0.35	53.0	67.0	72.3	47	73	75.5	1	0.6	7208C
18.2	14	0.40	57.3	72.5	78.1	52	78	80.5	1	0.6	7209C
19.4	17	0.45	62.2	77.6	83.2	57	83	85.5	1	0.6	7210C
20.9	21	0.59	69.0	86.0	92.3	63.5	91.5	94.5	1.5	1	7211C
22.6	28	0.76	77.0	96.0	102.9	68.5	101.5	104.5	1.5	1	7212C
23.9	34	0.95	82.5	102.5	109.7	73.5	111.5	114.5	1.5	1	7213C
25.1	40	1.04	87.0	108.0	115.5	78.5	116.5	119.5	1.5	1	7214C
26.4	43	1.14	93.0	114.0	121.5	83.5	121.5	124.5	1.5	1	7215C
27.8	54	1.39	98.1	121.4	129.6	90	130	134.5	2	1	7216C
29.9	63	1.73	106.1	129.9	138.5	95	140	144.5	2	1	7217C
31.8	80	2.13	111.6	138.5	147.9	100	150	154.5	2	1	7218C
33.8	96	2.58	118.2	146.8	157.0	107	158	163	2	1	7219C
35.8	119	3.21	124.8	155.2	166.2	112	168	173	2	1	7220C
37.8	147	3.81	131.3	163.7	175.3	117	178	183	2	1	7221CT1B
39.9	171	4.49	138.0	172.0	184.4	122	188	193	2	1	7222CT1B
42.5	206	5.44	149.0	186.0	198.6	132	203	208	2	1	7224CT1B
44.2	232	6.19	161.0	199.0	212.6	144	216	223	2.5	1	7226CT1B

## ULTAGE Standard angular contact ball bearings (ceramic ball type) 5S-79 series

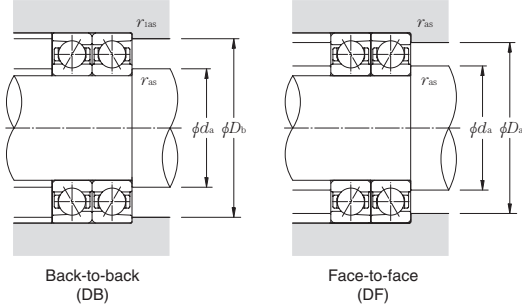
Contact angle 15°  $d$  10~130mm



Part number	Boundary dimensions						Basic load ratings				Static axial load capacity		Factor $f_0$	Limiting speed	
	mm						dynamic kN		static kgf		kN	kgf		min <sup>-1</sup>	
	$d$	$D$	$B$	$r_{s \min}$ ①	$r_{1s \min}$ ①	$C_r$	$C_{or}$	$C_r$	$C_{or}$	grease lubrication				oil lubrication	
5S-7900UC	10	22	6	0.3	0.15	3.20	1.15	325	117	1.94	198	9.8	84 000	136 800	
5S-7901UC	12	24	6	0.3	0.15	3.35	1.29	340	131	2.18	223	10.2	74 600	121 600	
5S-7902UC	15	28	7	0.3	0.15	5.10	2.01	520	205	3.40	345	10.0	62 500	101 900	
5S-7903UC	17	30	7	0.3	0.15	5.35	2.22	545	226	3.75	385	10.3	57 200	93 200	
5S-7904UC	20	37	9	0.3	0.15	7.65	3.40	780	345	5.75	585	10.3	47 100	76 800	
5S-7905UC	25	42	9	0.3	0.15	8.15	4.00	835	405	6.80	695	10.7	40 100	65 400	
5S-7906UC	30	47	9	0.3	0.15	8.60	4.60	880	470	7.85	800	11.0	34 900	56 900	
5S-7907UC	35	55	10	0.6	0.3	13.7	7.10	1 400	725	12.1	1 240	10.7	29 900	48 700	
5S-7908UC	40	62	12	0.6	0.3	14.5	8.15	1 480	830	13.9	1 420	11.0	26 300	42 900	
5S-7909UC	45	68	12	0.6	0.3	17.9	10.3	1 830	1 050	17.6	1 790	11.0	23 800	38 800	
5S-7910UC	50	72	12	0.6	0.3	18.9	11.5	1 930	1 180	19.7	2 010	11.1	22 000	35 900	
5S-7911UC	55	80	13	1	0.6	19.7	12.8	2 010	1 310	22.0	2 240	11.3	19 900	32 400	
5S-7912UC	60	85	13	1	0.6	20.5	14.1	2 090	1 440	24.2	2 460	11.4	18 500	30 200	
5S-7913UC	65	90	13	1	0.6	20.8	14.8	2 120	1 510	25.4	2 590	11.4	17 300	28 300	
5S-7914UC	70	100	16	1	0.6	29.7	20.9	3 050	2 140	36.0	3 650	11.4	15 800	25 800	
5S-7915UC	75	105	16	1	0.6	30.0	22.0	3 050	2 240	37.5	3 850	11.5	14 900	24 300	
5S-7916UC	80	110	16	1	0.6	30.5	23.0	3 100	2 340	39.5	4 000	11.4	14 100	22 900	
5S-7917UC	85	120	18	1.1	0.6	41.0	30.5	4 200	3 100	52.0	5 350	11.4	13 100	21 400	
5S-7918UC	90	125	18	1.1	0.6	41.5	32.0	4 250	3 250	54.5	5 550	11.5	12 500	20 400	
5S-7919UC	95	130	18	1.1	0.6	42.5	33.5	4 300	3 400	57.0	5 800	11.4	11 900	19 500	
5S-7920UC	100	140	20	1.1	0.6	54.5	42.5	5 550	4 300	72.5	7 400	11.4	11 200	18 200	
5S-7921UC	105	145	20	1.1	0.6	55.0	44.0	5 600	4 500	75.5	7 700	11.5	10 800	17 500	
5S-7922UC	110	150	20	1.1	0.6	56.0	46.0	5 700	4 700	78.5	8 050	11.4	10 300	16 800	
5S-7924UC	120	165	22	1.1	0.6	69.0	56.5	7 050	5 800	97.0	9 900	11.5	9 400	15 400	
5S-7926UC	130	180	24	1.5	1	85.0	70.5	8 650	7 200	121	12 300	11.5	8 700	14 100	

① Minimum allowable value for corner radius dimension  $r$  or  $r_1$ .





**Dynamic equivalent radial load**

$$P_r = X F_r + Y F_a$$

$i \cdot f_0 \cdot F_a / C_{or}$	e	Single row / Tandem				Back-to-back / Face-to-face			
		$F_d F_r \leq e$		$F_d F_r > e$		$F_d F_r \leq e$		$F_d F_r > e$	
		X	Y	X	Y	X	Y	X	Y
0.178	0.38			1.47		1.65		2.39	
0.357	0.4			1.4		1.57		2.28	
0.714	0.43			1.3		1.46		2.11	
1.07	0.46			1.23		1.38		2	
1.43	0.47	1	0	1.19	1	1.34	0.72	1.93	
2.14	0.5			1.12		1.26		1.82	
3.57	0.55			1.02		1.14		1.66	
5.35	0.56			1		1.12		1.63	
7.14	0.56			1		1.12		1.63	

**Static equivalent radial load**

$$P_{or} = X_0 F_r + Y_0 F_a$$

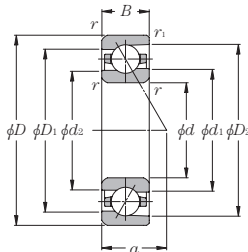
Single row / Tandem		Back-to-back / Face-to-face	
$X_0$	$Y_0$	$X_0$	$Y_0$
0.5	0.46	1	0.92

When  $P_{or} < P_r$  with single-row or tandem arrangement,  $P_{or} = P_r$ .

Load center mm	Internal free space cm <sup>3</sup>	Mass kg	Reference dimensions				Abutment and fillet dimensions					Part number
			mm				mm					
a	Single-row (approx.)	Single-row (approx.)	d <sub>1</sub>	d <sub>2</sub>	D <sub>1</sub>	D <sub>2</sub>	d <sub>a</sub> min	D <sub>a</sub> max	D <sub>b</sub> max	r <sub>as</sub> max	r <sub>1as</sub> max	
5.2	0.4	0.009	14.3	13.5	17.7	19.4	12.5	19.5	20.8	0.3	0.15	5S-7900UC
5.4	0.4	0.010	16.3	15.5	19.7	21.3	14.5	21.5	22.8	0.3	0.15	5S-7901UC
6.4	0.8	0.013	19.3	18.3	23.7	25.6	17.5	25.5	26.8	0.3	0.15	5S-7902UC
6.7	0.8	0.015	21.3	20.3	25.7	27.8	19.5	27.5	28.8	0.3	0.15	5S-7903UC
8.3	1.5	0.033	25.9	24.7	31.1	33.6	22.5	34.5	35.8	0.3	0.15	5S-7904UC
9.0	1.8	0.039	30.9	29.7	36.1	38.6	27.5	39.5	40.8	0.3	0.15	5S-7905UC
9.7	2.0	0.044	35.9	34.7	41.1	43.6	32.5	44.5	45.8	0.3	0.15	5S-7906UC
11.1	3.4	0.062	41.6	39.9	48.4	51.7	39.5	50.5	52.5	0.6	0.3	5S-7907UC
12.9	4.7	0.10	47.6	45.9	54.4	57.8	44.5	57.5	59.5	0.6	0.3	5S-7908UC
13.6	5.9	0.11	52.7	50.8	60.4	64.0	49.5	63.5	65.5	0.6	0.3	5S-7909UC
14.2	6.2	0.11	57.2	55.3	64.9	68.5	54.5	67.5	69.5	0.6	0.3	5S-7910UC
15.6	7.5	0.16	63.7	61.8	71.4	75.1	60.5	74.5	75.5	1	0.6	5S-7911UC
16.3	8.0	0.17	68.7	66.8	76.4	80.1	65.5	79.5	80.5	1	0.6	5S-7912UC
16.9	8.6	0.19	73.7	71.8	81.4	85.1	70.5	84.5	85.5	1	0.6	5S-7913UC
19.4	14	0.30	80.3	78.0	89.7	94.3	75.5	94.5	95.5	1	0.6	5S-7914UC
20.1	15	0.32	85.3	83.0	94.7	99.3	80.5	99.5	100.5	1	0.6	5S-7915UC
20.8	16	0.33	90.8	88.5	100.2	104.8	85.5	104.5	105.5	1	0.6	5S-7916UC
22.8	22	0.47	96.9	94.3	108.1	113.5	92	113	115.5	1	0.6	5S-7917UC
23.5	23	0.49	101.9	99.3	113.1	118.5	97	118	120.5	1	0.6	5S-7918UC
24.1	24	0.52	106.9	104.3	118.1	123.5	102	123	125.5	1	0.6	5S-7919UC
26.1	33	0.70	113.6	110.5	126.4	132.7	107	133	135.5	1	0.6	5S-7920UC
26.8	34	0.73	118.6	115.5	131.4	137.7	112	138	140.5	1	0.6	5S-7921UC
27.5	36	0.76	123.6	120.5	136.4	142.7	117	143	145.5	1	0.6	5S-7922UC
30.2	48	1.03	135.2	131.7	149.8	156.8	127	158	160.5	1	0.6	5S-7924UC
32.9	63	1.34	146.9	143.0	163.2	171.0	138.5	171.5	174.5	1.5	1	5S-7926UC

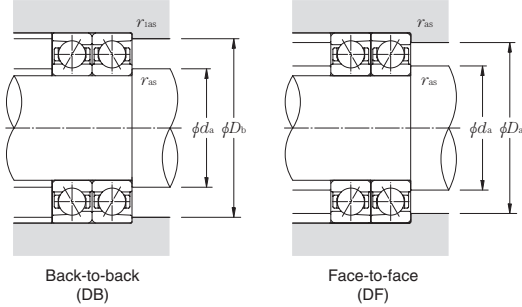
## ULTAGE Standard angular contact ball bearings (ceramic ball type) 5S-79 series

Contact angle 25°  $d$  10~130mm



Part number	Boundary dimensions						Basic load ratings				Static axial load capacity		Limiting speed	
	mm						dynamic		static		kN	kgf	min <sup>-1</sup>	
	$d$	$D$	$B$	$r_{s\ min}$ ①	$r_{1s\ min}$ ①	$C_r$	$C_{or}$	$C_r$	$C_{or}$	grease lubrication			oil lubrication	
5S-7900UAD	10	22	6	0.3	0.15	3.05	1.10	310	112	2.12	216	73 200	120 100	
5S-7901UAD	12	24	6	0.3	0.15	3.20	1.23	325	125	2.30	234	65 100	106 800	
5S-7902UAD	15	28	7	0.3	0.15	4.85	1.92	495	196	3.35	345	54 500	89 400	
5S-7903UAD	17	30	7	0.3	0.15	5.10	2.12	520	216	3.60	370	49 800	81 800	
5S-7904UAD	20	37	9	0.3	0.15	7.25	3.25	740	330	5.60	575	41 100	67 400	
5S-7905UAD	25	42	9	0.3	0.15	7.75	3.80	790	385	6.40	650	35 000	57 400	
5S-7906UAD	30	47	9	0.3	0.15	8.15	4.35	830	445	7.15	730	30 400	49 900	
5S-7907UAD	35	55	10	0.6	0.3	13.0	6.75	1 320	690	12.1	1 240	26 000	42 700	
5S-7908UAD	40	62	12	0.6	0.3	13.7	7.75	1 400	790	13.6	1 380	23 000	37 700	
5S-7909UAD	45	68	12	0.6	0.3	17.0	9.75	1 730	995	17.5	1 790	20 700	34 000	
5S-7910UAD	50	72	12	0.6	0.3	17.9	10.9	1 820	1 110	19.3	1 970	19 200	31 500	
5S-7911UAD	55	80	13	1	0.6	18.6	12.2	1 900	1 240	21.1	2 160	17 400	28 500	
5S-7912UAD	60	85	13	1	0.6	19.4	13.3	1 970	1 360	23.0	2 340	16 200	26 500	
5S-7913UAD	65	90	13	1	0.6	19.6	14.0	2 000	1 430	23.9	2 430	15 100	24 800	
5S-7914UAD	70	100	16	1	0.6	28.0	19.8	2 860	2 020	33.5	3 400	13 800	22 600	
5S-7915UAD	75	105	16	1	0.6	28.4	20.8	2 900	2 120	34.5	3 550	13 000	21 400	
5S-7916UAD	80	110	16	1	0.6	28.7	21.7	2 930	2 220	36.0	3 700	12 300	20 100	
5S-7917UAD	85	120	18	1.1	0.6	38.5	28.9	3 950	2 950	47.0	4 800	11 400	18 800	
5S-7918UAD	90	125	18	1.1	0.6	39.5	30.0	4 000	3 100	49.0	5 000	10 900	17 900	
5S-7919UAD	95	130	18	1.1	0.6	40.0	31.5	4 050	3 200	51.0	5 200	10 400	17 100	
5S-7920UAD	100	140	20	1.1	0.6	51.0	40.0	5 200	4 100	67.5	6 850	9 800	16 000	
5S-7921UAD	105	145	20	1.1	0.6	52.0	41.5	5 300	4 250	70.0	7 100	9 400	15 400	
5S-7922UAD	110	150	20	1.1	0.6	52.5	43.5	5 400	4 450	72.5	7 400	9 000	14 800	
5S-7924UAD	120	165	22	1.1	0.6	65.0	53.5	6 650	5 450	88.0	8 950	8 200	13 500	
5S-7926UAD	130	180	24	1.5	1	80.0	66.5	8 150	6 800	112	11 400	7 600	12 400	

① Minimum allowable value for corner radius dimension  $r$  or  $r_1$ .



**Dynamic equivalent radial load**  $P_r = X F_r + Y F_a$

e	Single row / Tandem				Back-to-back / Face-to-face			
	$F_a / F_r \leq e$		$F_a / F_r > e$		$F_a / F_r \leq e$		$F_a / F_r > e$	
	X	Y	X	Y	X	Y	X	Y
0.68	1	0	0.41	0.87	1	0.92	0.67	1.41

**Static equivalent radial load**  $P_{or} = X_0 F_r + Y_0 F_a$

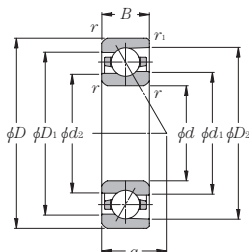
Single row / Tandem		Back-to-back / Face-to-face	
$X_0$	$Y_0$	$X_0$	$Y_0$
0.5	0.38	1	0.76

When  $P_{or} < F_r$  with single-row or tandem arrangement,  $P_{or} = F_r$ .

Load center mm	Internal free space cm <sup>3</sup> Single-row (approx.)	Mass kg Single-row (approx.)	Reference dimensions mm				Abutment and fillet dimensions mm					Part number
			d <sub>1</sub>	d <sub>2</sub>	D <sub>1</sub>	D <sub>2</sub>	d <sub>a</sub> min	D <sub>a</sub> max	D <sub>b</sub> max	r <sub>as</sub> max	r <sub>1as</sub> max	
6.8	0.4	0.009	14.3	13.5	17.7	19.4	12.5	19.5	20.8	0.3	0.15	5S-7900UAD
7.2	0.4	0.010	16.3	15.5	19.7	21.3	14.5	21.5	22.8	0.3	0.15	5S-7901UAD
8.6	0.8	0.013	19.3	18.3	23.7	25.7	17.5	25.5	26.8	0.3	0.15	5S-7902UAD
9.0	0.8	0.015	21.3	20.3	25.7	27.7	19.5	27.5	28.8	0.3	0.15	5S-7903UAD
11.2	1.5	0.033	25.9	24.7	31.1	33.6	22.5	34.5	35.8	0.3	0.15	5S-7904UAD
12.4	1.8	0.039	30.9	29.7	36.1	38.6	27.5	39.5	40.8	0.3	0.15	5S-7905UAD
13.5	2.0	0.044	35.9	34.7	41.1	43.6	32.5	44.5	45.8	0.3	0.15	5S-7906UAD
15.6	3.4	0.062	41.6	39.9	48.4	51.7	39.5	50.5	52.5	0.6	0.3	5S-7907UAD
18.0	4.7	0.100	47.6	45.9	54.4	57.7	44.5	57.5	59.5	0.6	0.3	5S-7908UAD
19.2	5.9	0.110	52.7	50.8	60.4	64.0	49.5	63.5	65.5	0.6	0.3	5S-7909UAD
20.3	6.2	0.110	57.2	55.3	64.9	68.5	54.5	67.5	69.5	0.6	0.3	5S-7910UAD
22.3	7.5	0.160	63.7	61.8	71.4	75.1	60.5	74.5	75.5	1	0.6	5S-7911UAD
23.5	8.0	0.170	68.7	66.8	76.4	80.0	65.5	79.5	80.5	1	0.6	5S-7912UAD
24.6	8.6	0.190	73.7	71.8	81.4	85.0	70.5	84.5	85.5	1	0.6	5S-7913UAD
27.9	14	0.300	80.3	78	89.7	94.3	75.5	94.5	95.5	1	0.6	5S-7914UAD
29.1	15	0.320	85.3	83	94.7	99.3	80.5	99.5	100.5	1	0.6	5S-7915UAD
30.4	16	0.330	90.8	88.5	100.2	104.7	85.5	104.5	105.5	1	0.6	5S-7916UAD
33.0	22	0.470	96.9	94.3	108.1	113.5	92	113	115.5	1	0.6	5S-7917UAD
34.2	23	0.490	101.9	99.3	113.1	118.5	97	118	120.5	1	0.6	5S-7918UAD
35.3	24	0.520	106.9	104.3	118.1	123.4	102	123	125.5	1	0.6	5S-7919UAD
38.1	33	0.700	113.6	110.5	126.4	132.6	107	133	135.5	1	0.6	5S-7920UAD
39.3	34	0.730	118.6	115.5	131.4	137.6	112	138	140.5	1	0.6	5S-7921UAD
40.4	36	0.760	123.6	120.5	136.4	142.6	117	143	145.5	1	0.6	5S-7922UAD
44.4	48	1.03	135.2	131.7	149.8	156.7	127	158	160.5	1	0.6	5S-7924UAD
48.3	63	1.34	146.9	143	163.2	170.9	138.5	171.5	174.5	1.5	1	5S-7926UAD

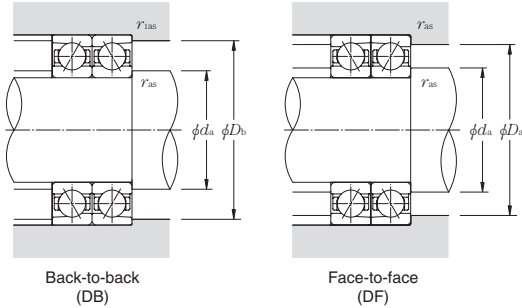
## ULTAGE Standard angular contact ball bearings (ceramic ball type) 5S-79 series

Contact angle 30°  $d$  10~130mm



Part number	Boundary dimensions						Basic load ratings				Static axial load capacity		Limiting speed	
	mm						dynamic	static	dynamic	static	kN	kgf	min <sup>-1</sup>	
	$d$	$D$	$B$	$r_{s \min}$ ①	$r_{1s \min}$ ①	$C_r$	$C_{or}$	$C_r$	$C_{or}$	grease lubrication			oil lubrication	
5S-7900U	10	22	6	0.3	0.15	2.95	1.06	300	108	1.63	166	58 600	78 000	
5S-7901U	12	24	6	0.3	0.15	3.10	1.19	315	121	1.77	181	52 100	69 400	
5S-7902U	15	28	7	0.3	0.15	4.70	1.86	480	190	2.56	261	43 600	58 100	
5S-7903U	17	30	7	0.3	0.15	4.90	2.05	500	209	2.74	280	39 900	53 100	
5S-7904U	20	37	9	0.3	0.15	7.00	3.10	715	320	4.30	440	32 900	43 800	
5S-7905U	25	42	9	0.3	0.15	7.45	3.65	760	375	4.90	500	28 000	37 300	
5S-7906U	30	47	9	0.3	0.15	7.80	4.20	800	430	5.50	560	24 300	32 400	
5S-7907U	35	55	10	0.6	0.3	12.5	6.50	1 270	665	9.35	955	20 800	27 800	
5S-7908U	40	62	12	0.6	0.3	13.1	7.45	1 340	760	10.5	1 070	18 400	24 500	
5S-7909U	45	68	12	0.6	0.3	16.3	9.40	1 660	960	13.6	1 390	16 600	22 100	
5S-7910U	50	72	12	0.6	0.3	17.2	10.5	1 750	1 070	15.0	1 530	15 400	20 500	
5S-7911U	55	80	13	1	0.6	17.8	11.7	1 820	1 190	16.5	1 680	13 900	18 500	
5S-7912U	60	85	13	1	0.6	18.6	12.8	1 890	1 310	18.0	1 830	12 900	17 200	
5S-7913U	65	90	13	1	0.6	18.8	13.5	1 910	1 370	18.7	1 910	12 100	16 100	
5S-7914U	70	100	16	1	0.6	26.9	19.1	2 740	1 940	25.7	2 620	11 000	14 700	
5S-7915U	75	105	16	1	0.6	27.2	20.0	2 780	2 040	26.7	2 730	10 400	13 900	
5S-7916U	80	110	16	1	0.6	27.5	20.9	2 810	2 130	27.8	2 830	9 800	13 100	
5S-7917U	85	120	18	1.1	0.6	37.0	27.8	3 800	2 830	36.0	3 700	9 100	12 200	
5S-7918U	90	125	18	1.1	0.6	37.5	29.0	3 850	2 960	37.5	3 850	8 700	11 600	
5S-7919U	95	130	18	1.1	0.6	38.0	30.5	3 900	3 100	39.0	4 000	8 300	11 100	
5S-7920U	100	140	20	1.1	0.6	49.0	38.5	5 000	3 900	52.0	5 300	7 800	10 400	
5S-7921U	105	145	20	1.1	0.6	50.0	40.0	5 100	4 100	54.0	5 500	7 500	10 000	
5S-7922U	110	150	20	1.1	0.6	50.5	41.5	5 150	4 250	56.0	5 700	7 200	9 600	
5S-7924U	120	165	22	1.1	0.6	62.5	51.5	6 350	5 250	67.5	6 900	6 600	8 800	
5S-7926U	130	180	24	1.5	1	76.5	64.0	7 800	6 550	86.5	8 850	6 000	8 100	

① Minimum allowable value for corner radius dimension  $r$  or  $r_1$ .



**Dynamic equivalent radial load**  $P_r = X F_r + Y F_a$

e	Single row / Tandem				Back-to-back / Face-to-face			
	$F_a / F_r \leq e$		$F_a / F_r > e$		$F_a / F_r \leq e$		$F_a / F_r > e$	
	X	Y	X	Y	X	Y	X	Y
0.8	1	0	0.39	0.76	1	0.78	0.63	1.24

**Static equivalent radial load**  $P_{or} = X_0 F_r + Y_0 F_a$

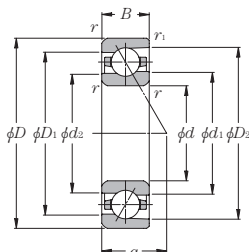
Single row / Tandem		Back-to-back / Face-to-face	
$X_0$	$Y_0$	$X_0$	$Y_0$
0.5	0.33	1	0.66

When  $P_{or} < F_r$  with single-row or tandem arrangement,  $P_{or} = F_r$ .

Load center mm	Internal free space cm <sup>3</sup> Single-row (approx.)	Mass kg Single-row (approx.)	Reference dimensions mm				Abutment and fillet dimensions mm					Part number
			$d_1$	$d_2$	$D_1$	$D_2$	$d_a$ min	$D_a$ max	$D_b$ max	$r_{as}$ max	$r_{1as}$ max	
7.7	0.4	0.009	14.3	13.5	17.7	19.3	12.5	19.5	20.8	0.3	0.15	5S-7900U
8.2	0.4	0.010	16.3	15.5	19.7	21.3	14.5	21.5	22.8	0.3	0.15	5S-7901U
9.8	0.8	0.013	19.3	18.3	23.7	25.6	17.5	25.5	26.8	0.3	0.15	5S-7902U
10.3	0.8	0.015	21.3	20.3	25.7	27.7	19.5	27.5	28.8	0.3	0.15	5S-7903U
12.8	1.5	0.033	25.9	24.7	31.1	33.5	22.5	34.5	35.8	0.3	0.15	5S-7904U
14.2	1.8	0.039	30.9	29.7	36.1	38.5	27.5	39.5	40.8	0.3	0.15	5S-7905U
15.7	2.0	0.044	35.9	34.7	41.1	43.5	32.5	44.5	45.8	0.3	0.15	5S-7906U
18.1	3.4	0.062	41.6	39.9	48.4	51.6	39.5	50.5	52.5	0.6	0.3	5S-7907U
20.8	4.7	0.10	47.6	45.9	54.4	57.7	44.5	57.5	59.5	0.6	0.3	5S-7908U
22.4	5.9	0.11	52.7	50.8	60.4	64.0	49.5	63.5	65.5	0.6	0.3	5S-7909U
23.7	6.2	0.11	57.2	55.3	64.9	68.4	54.5	67.5	69.5	0.6	0.3	5S-7910U
26.1	7.5	0.16	63.7	61.8	71.4	75.0	60.5	74.5	75.5	1	0.6	5S-7911U
27.5	8.0	0.17	68.7	66.8	76.4	80.0	65.5	79.5	80.5	1	0.6	5S-7912U
29.0	8.6	0.19	73.7	71.8	81.4	85.0	70.5	84.5	85.5	1	0.6	5S-7913U
32.6	14	0.30	80.3	78.0	89.7	94.2	75.5	94.5	95.5	1	0.6	5S-7914U
34.1	15	0.32	85.3	83.0	94.7	99.2	80.5	99.5	100.5	1	0.6	5S-7915U
35.7	16	0.30	90.8	88.5	100.2	104.7	85.5	104.5	105.5	1	0.6	5S-7916U
38.7	22	0.47	96.9	94.3	108.1	113.4	92	113	115.5	1	0.6	5S-7917U
40.2	23	0.49	101.9	99.3	113.1	118.4	97	118	120.5	1	0.6	5S-7918U
41.6	24	0.52	106.9	104.3	118.1	123.4	102	123	125.5	1	0.6	5S-7919U
44.8	33	0.70	113.6	110.5	126.4	132.6	107	133	135.5	1	0.6	5S-7920U
46.2	34	0.73	118.6	115.5	131.4	137.6	112	138	140.5	1	0.6	5S-7921U
47.7	36	0.76	123.6	120.5	136.4	142.6	117	143	145.5	1	0.6	5S-7922U
52.3	48	1.03	135.2	131.7	149.8	156.7	127	158	160.5	1	0.6	5S-7924U
56.9	63	1.34	146.9	143.0	163.2	170.9	138.5	171.5	174.5	1.5	1	5S-7926U

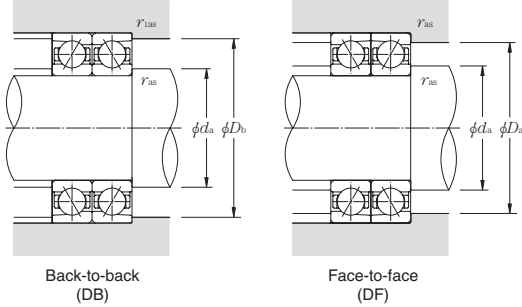
## ULTAGE Standard angular contact ball bearings (ceramic ball type) 5S-70 series

Contact angle 15°  $d$  10~130mm



Part number	Boundary dimensions						Basic load ratings				Static axial load capacity		Factor	Limiting speed	
	mm						dynamic		static		kN	kgf		min <sup>-1</sup>	
	$d$	$D$	$B$	$r_{1s}$ min <sup>①</sup>	$r_{1s}$ min <sup>①</sup>	$C_r$	$C_{or}$	$C_r$	$C_{or}$	kN				kgf	grease lubrication
5S-7000UC	10	26	8	0.3	0.15	5.30	1.72	540	175	2.88	293	8.7	75 500	123 000	
5S-7001UC	12	28	8	0.3	0.15	5.80	2.03	595	207	3.40	350	9.3	65 500	106 800	
5S-7002UC	15	32	9	0.3	0.15	6.60	2.56	675	261	4.35	440	9.7	57 200	93 200	
5S-7003UC	17	35	10	0.3	0.15	8.25	3.15	840	320	5.30	540	9.6	51 700	84 200	
5S-7004UC	20	42	12	0.6	0.3	11.1	4.55	1 130	465	7.70	785	9.8	42 700	69 500	
5S-7005UC	25	47	12	0.6	0.3	12.3	5.55	1 250	565	9.40	960	10.2	37 300	60 800	
5S-7006UC	30	55	13	1	0.6	15.8	7.65	1 620	780	13.0	1 320	10.3	31 200	50 900	
5S-7007UC	35	62	14	1	0.6	20.0	10.1	2 040	1 030	17.2	1 750	10.4	27 700	45 100	
5S-7008UC	40	68	15	1	0.6	21.4	11.7	2 180	1 190	19.9	2 020	10.6	24 900	40 500	
5S-7009UC	45	75	16	1	0.6	25.3	14.1	2 580	1 440	24.1	2 460	10.7	22 400	36 500	
5S-7010UC	50	80	16	1	0.6	26.9	16.0	2 740	1 630	27.3	2 780	10.9	20 700	33 700	
5S-7011UC	55	90	18	1.1	0.6	35.5	20.9	3 600	2 140	35.5	3 650	10.7	18 500	30 200	
5S-7012UC	60	95	18	1.1	0.6	36.5	22.4	3 700	2 280	38.0	3 900	10.9	17 300	28 300	
5S-7013UC	65	100	18	1.1	0.6	38.5	24.9	3 900	2 540	42.5	4 350	11.0	16 300	26 500	
5S-7014UC	70	110	20	1.1	0.6	48.5	31.5	4 950	3 200	53.5	5 450	10.9	14 900	24 300	
5S-7015UC	75	115	20	1.1	0.6	49.5	33.0	5 050	3 400	56.5	5 750	11.0	14 100	23 000	
5S-7016UC	80	125	22	1.1	0.6	60.5	40.0	6 200	4 100	68.5	7 000	10.9	13 100	21 400	
5S-7017UC	85	130	22	1.1	0.6	62.0	42.5	6 350	4 350	72.5	7 400	11.0	12 500	20 400	
5S-7018UC	90	140	24	1.5	1	74.0	50.5	7 550	5 150	86.0	8 750	10.9	11 700	19 000	
5S-7019UC	95	145	24	1.5	1	76.0	53.0	7 750	5 400	90.5	9 250	11.0	11 200	18 200	
5S-7020UC	100	150	24	1.5	1	77.5	56.0	7 900	5 700	95.5	9 750	11.1	10 800	17 500	
5S-7021UC	105	160	26	2	1	91.0	65.0	9 250	6 600	111	11 300	11.0	10 100	16 500	
5S-7022UC	110	170	28	2	1	104	74.0	10 600	7 500	126	12 800	10.9	9 600	15 600	
5S-7024UC	120	180	28	2	1	106	78.5	10 800	8 000	134	13 600	11.1	9 000	14 600	
5S-7026UC	130	200	33	2	1	133	99.5	13 600	10 200	170	17 300	11.0	8 100	13 300	
5S-7028UC	140	210	33	2	1	136	105.0	13 900	10 700	179	18 300	11.1	7 600	12 500	

① Minimum allowable value for corner radius dimension  $r$  or  $r_1$ .



**Dynamic equivalent radial load**

$$P_r = X F_r + Y F_a$$

$i \cdot f_0 \cdot F_a / C_{Or}$	$e$	Single row / Tandem				Back-to-back / Face-to-face			
		$F_d / F_r \leq e$		$F_d / F_r > e$		$F_d / F_r \leq e$		$F_d / F_r > e$	
		X	Y	X	Y	X	Y	X	Y
0.173	0.38			1.47	1.65			2.39	
0.357	0.4			1.4	1.57			2.28	
0.714	0.43			1.3	1.46			2.11	
1.07	0.46			1.23	1.38			2	
1.43	0.47	1	0	1.19	1	1	1.34	1.93	
2.14	0.5			1.12	1.26		0.72	1.82	
3.57	0.55			1.02	1.14			1.66	
5.35	0.56			1	1.12			1.63	
7.14	0.56			1	1.12			1.63	

**Static equivalent radial load**

$$P_{Or} = X_0 F_r + Y_0 F_a$$

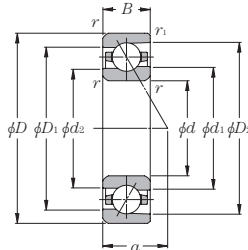
Single row / Tandem		Back-to-back / Face-to-face	
$X_0$	$Y_0$	$X_0$	$Y_0$
0.5	0.46	1	0.92

When  $P_{Or} < P_r$  with single-row or tandem arrangement,  $P_{Or} = P_r$ .

Load center mm	Internal free space cm <sup>3</sup> Single-row (approx.)	Mass kg Single-row (approx.)	Reference dimensions mm				Abutment and fillet dimensions mm					Part number
			$d_1$	$d_2$	$D_1$	$D_2$	$d_a$ min	$D_a$ max	$D_b$ max	$r_{as}$ max	$r_{1as}$ max	
6.4	0.9	0.017	15.2	14.0	20.4	22.7	12.5	23.5	24.8	0.3	0.15	5S-7000UC
6.8	1.0	0.018	17.9	16.7	23.1	25.6	14.5	25.5	26.8	0.3	0.15	5S-7001UC
7.7	1.3	0.027	20.9	19.7	26.1	28.7	17.5	29.5	30.8	0.3	0.15	5S-7002UC
8.5	1.8	0.033	23.0	21.6	29.0	32.0	19.5	32.5	33.8	0.3	0.15	5S-7003UC
10.3	2.9	0.060	28.1	26.4	34.9	38.4	24.5	37.5	39.5	0.6	0.3	5S-7004UC
10.9	3.3	0.071	32.6	30.9	39.4	42.9	29.5	42.5	44.5	0.6	0.3	5S-7005UC
12.3	4.8	0.10	39.2	37.3	46.9	50.7	35.5	49.5	50.5	1	0.6	5S-7006UC
13.5	6.3	0.13	44.2	42.2	52.8	57.0	40.5	56.5	57.5	1	0.6	5S-7007UC
14.8	7.4	0.17	49.7	47.7	58.3	62.5	45.5	62.5	63.5	1	0.6	5S-7008UC
16.1	9.4	0.21	55.3	53.0	64.7	69.4	50.5	69.5	70.5	1	0.6	5S-7009UC
16.8	11	0.23	60.3	58.0	69.7	74.4	55.5	74.5	75.5	1	0.6	5S-7010UC
18.8	16	0.33	66.9	64.3	78.1	83.6	62	83	85.5	1	0.6	5S-7011UC
19.4	17	0.36	71.9	69.3	83.1	88.6	67	88	90.5	1	0.6	5S-7012UC
20.1	18	0.38	76.9	74.3	88.1	93.5	72	93	95.5	1	0.6	5S-7013UC
22.1	24	0.53	83.6	80.5	96.4	102.7	77	103	105.5	1	0.6	5S-7014UC
22.8	26	0.56	88.6	85.5	101.4	107.7	82	108	110.5	1	0.6	5S-7015UC
24.8	34	0.74	95.2	91.7	109.8	116.9	87	118	120.5	1	0.6	5S-7016UC
25.5	36	0.78	100.2	96.7	114.8	121.9	92	123	125.5	1	0.6	5S-7017UC
27.5	47	1.00	106.9	103.0	123.2	131.1	98.5	131.5	134.5	1.5	1	5S-7018UC
28.2	49	1.04	111.9	108.0	128.2	136.1	103.5	136.5	139.5	1.5	1	5S-7019UC
28.8	51	1.09	116.9	113.0	133.2	141.1	108.5	141.5	144.5	1.5	1	5S-7020UC
30.8	70	1.34	123.5	119.2	141.5	150.2	115	150	154.5	2	1	5S-7021UC
32.9	83	1.69	130.2	125.4	149.9	159.4	120	160	164.5	2	1	5S-7022UC
34.2	90	1.80	140.2	135.4	159.9	169.4	130	170	174.5	2	1	5S-7024UC
38.7	131	2.80	153.9	148.5	176.2	187.1	140	190	194.5	2	1	5S-7026UC
40.1	144	2.90	164.0	158.7	186.3	197.1	150	200	204.5	2	1	5S-7028UC

## ULTAGE Standard angular contact ball bearings (ceramic ball type) 5S-70 series

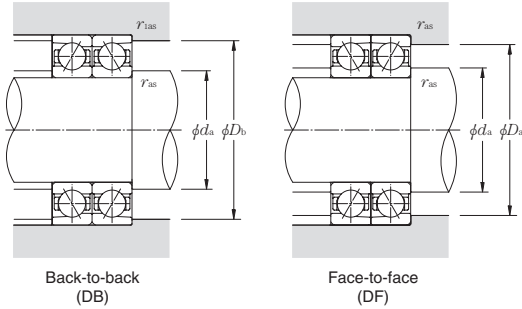
Contact angle 25°  $d$  10~130mm



Part number	Boundary dimensions						Basic load ratings				Static axial load capacity		Limiting speed	
	mm						dynamic		static		kN	kgf	min <sup>-1</sup>	
	<i>d</i>	<i>D</i>	<i>B</i>	<i>r</i> <sub>s min</sub> ①	<i>r</i> <sub>1s min</sub> ①	<i>C<sub>r</sub></i>	<i>C<sub>or</sub></i>	<i>C<sub>r</sub></i>	<i>C<sub>or</sub></i>	grease lubrication			oil lubrication	
5S-7000UAD	10	26	8	0.3	0.15	5.15	1.66	525	169	3.30	340	65 800	107 900	
5S-7001UAD	12	28	8	0.3	0.15	5.60	1.95	570	199	3.70	380	57 100	93 700	
5S-7002UAD	15	32	9	0.3	0.15	6.35	2.45	645	250	4.45	455	49 800	81 800	
5S-7003UAD	17	35	10	0.3	0.15	7.90	3.00	805	305	5.80	590	45 000	73 900	
5S-7004UAD	20	42	12	0.6	0.3	10.6	4.35	1 080	445	8.45	865	37 200	61 000	
5S-7005UAD	25	47	12	0.6	0.3	11.7	5.30	1 190	540	9.90	1 010	32 500	53 400	
5S-7006UAD	30	55	13	1	0.6	15.1	7.30	1 540	745	13.8	1 400	27 200	44 700	
5S-7007UAD	35	62	14	1	0.6	19.0	9.65	1 940	980	17.1	1 740	24 100	39 600	
5S-7008UAD	40	68	15	1	0.6	20.3	11.1	2 070	1 130	19.3	1 970	21 700	35 600	
5S-7009UAD	45	75	16	1	0.6	24.0	13.4	2 450	1 370	23.8	2 430	19 500	32 000	
5S-7010UAD	50	80	16	1	0.6	25.5	15.2	2 600	1 550	26.5	2 710	18 000	29 600	
5S-7011UAD	55	90	18	1.1	0.6	33.5	19.9	3 400	2 030	34.5	3 500	16 200	26 500	
5S-7012UAD	60	95	18	1.1	0.6	34.5	21.2	3 500	2 170	36.0	3 700	15 100	24 800	
5S-7013UAD	65	100	18	1.1	0.6	36.0	23.6	3 700	2 410	40.0	4 050	14 200	23 300	
5S-7014UAD	70	110	20	1.1	0.6	46.0	29.7	4 700	3 050	52.0	5 300	13 000	21 400	
5S-7015UAD	75	115	20	1.1	0.6	47.0	31.5	4 800	3 200	54.5	5 550	12 300	20 200	
5S-7016UAD	80	125	22	1.1	0.6	57.5	38.0	5 850	3 900	65.5	6 700	11 400	18 800	
5S-7017UAD	85	130	22	1.1	0.6	58.5	40.5	6 000	4 100	68.5	7 000	10 900	17 900	
5S-7018UAD	90	140	24	1.5	1	70.0	48.0	7 150	4 850	84.0	8 550	10 200	16 700	
5S-7019UAD	95	145	24	1.5	1	71.5	50.5	7 300	5 150	88.0	8 950	9 800	16 000	
5S-7020UAD	100	150	24	1.5	1	73.5	53.0	7 500	5 400	92.0	9 350	9 400	15 400	
5S-7021UAD	105	160	26	2	1	86.0	61.5	8 750	6 300	106	10 800	8 800	14 500	
5S-7022UAD	110	170	28	2	1	98.5	70.0	10 100	7 150	123	12 500	8 400	13 700	
5S-7024UAD	120	180	28	2	1	101	74.5	10 300	7 600	129	13 200	7 800	12 800	
5S-7026UAD	130	200	33	2	1	126	94.5	12 900	9 650	164	16 700	7 100	11 600	
5S-7028UAD	140	210	33	2	1	128	100.0	13 100	10 200	170	17 300	6 700	11 000	

① Minimum allowable value for corner radius dimension *r* or *r*<sub>1</sub>.





**Dynamic equivalent radial load**  $P_r = X F_r + Y F_a$

e	Single row / Tandem				Back-to-back / Face-to-face			
	$F_a / F_r \leq e$		$F_a / F_r > e$		$F_a / F_r \leq e$		$F_a / F_r > e$	
	X	Y	X	Y	X	Y	X	Y
0.68	1	0	0.41	0.87	1	0.92	0.67	1.41

**Static equivalent radial load**  $P_{or} = X_0 F_r + Y_0 F_a$

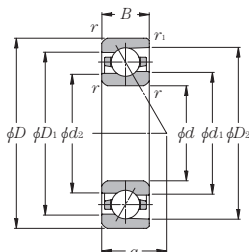
Single row / Tandem		Back-to-back / Face-to-face	
$X_0$	$Y_0$	$X_0$	$Y_0$
0.5	0.38	1	0.76

When  $P_{or} < F_r$  with single-row or tandem arrangement,  $P_{or} = F_r$ .

Load center mm	Internal free space cm <sup>3</sup>	Mass kg	Reference dimensions				Abutment and fillet dimensions					Part number
			mm				mm					
a	Single-row (approx.)	Single-row (approx.)	d <sub>1</sub>	d <sub>2</sub>	D <sub>1</sub>	D <sub>2</sub>	d <sub>a</sub> min	D <sub>a</sub> max	D <sub>b</sub> max	r <sub>as</sub> max	r <sub>1as</sub> max	
8.2	0.9	0.017	15.2	14.0	20.4	22.9	12.5	23.5	24.8	0.3	0.15	5S-7000UAD
8.8	1.0	0.018	17.9	16.7	23.1	25.6	14.5	25.5	26.8	0.3	0.15	5S-7001UAD
10.0	1.3	0.027	20.9	19.7	26.1	28.4	17.5	29.5	30.8	0.3	0.15	5S-7002UAD
11.1	1.8	0.033	23.0	21.6	29.0	32.0	19.5	32.5	33.8	0.3	0.15	5S-7003UAD
13.4	2.9	0.060	28.1	26.4	34.9	38.3	24.5	37.5	39.5	0.6	0.3	5S-7004UAD
14.5	3.3	0.071	32.6	30.9	39.4	42.8	29.5	42.5	44.5	0.6	0.3	5S-7005UAD
16.6	4.8	0.10	39.2	37.3	46.9	50.7	35.5	49.5	50.5	1	0.6	5S-7006UAD
18.4	6.3	0.13	44.2	42.2	52.8	56.9	40.5	56.5	57.5	1	0.6	5S-7007UAD
20.2	7.4	0.17	49.7	47.7	58.3	62.5	45.5	62.5	63.5	1	0.6	5S-7008UAD
22.1	9.4	0.21	55.3	53.0	64.7	69.3	50.5	69.5	70.5	1	0.6	5S-7009UAD
23.2	11	0.23	60.3	58.0	69.7	74.3	55.5	74.5	75.5	1	0.6	5S-7010UAD
26.0	16	0.33	66.9	64.3	78.1	83.5	62	83	85.5	1	0.6	5S-7011UAD
27.2	17	0.36	71.9	69.3	83.1	88.5	67	88	90.5	1	0.6	5S-7012UAD
28.3	18	0.38	76.9	74.3	88.1	93.5	72	93	95.5	1	0.6	5S-7013UAD
31.1	24	0.53	83.6	80.5	96.4	102.7	77	103	105.5	1	0.6	5S-7014UAD
32.3	26	0.56	88.6	85.5	101.4	107.7	82	108	110.5	1	0.6	5S-7015UAD
35.0	34	0.74	95.2	91.7	109.8	116.9	87	118	120.5	1	0.6	5S-7016UAD
36.2	36	0.78	100.2	96.7	114.8	121.9	92	123	125.5	1	0.6	5S-7017UAD
39.0	47	1.00	106.9	103.0	123.2	131.0	98.5	131.5	134.5	1.5	1	5S-7018UAD
40.1	49	1.04	111.9	108.0	128.2	136.0	103.5	136.5	139.5	1.5	1	5S-7019UAD
41.3	51	1.09	116.9	113.0	133.2	141.0	108.5	141.5	144.5	1.5	1	5S-7020UAD
44.1	70	1.34	123.5	119.2	141.5	150.2	115	150	154.5	2	1	5S-7021UAD
46.8	83	1.69	130.2	125.4	149.9	159.3	120	160	164.5	2	1	5S-7022UAD
49.2	90	1.80	140.2	135.4	159.9	169.3	130	170	174.5	2	1	5S-7024UAD
55.2	131	2.80	153.9	148.5	176.2	187.0	140	190	194.5	2	1	5S-7026UAD
57.5	144	2.90	164.0	158.7	186.3	197.0	150	200	204.5	2	1	5S-7028UAD

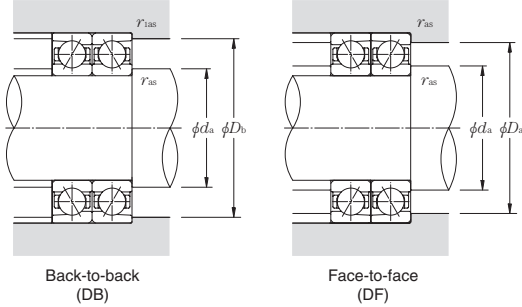
## ULTAGE Standard angular contact ball bearings (ceramic ball type) 5S-70 series

Contact angle 30°  $d$  10~130mm



Part number	Boundary dimensions						Basic load ratings				Static axial load capacity		Limiting speed	
	mm						dynamic		static		kN	kgf	min <sup>-1</sup>	
	$d$	$D$	$B$	$r_{s \min}$ ①	$r_{1s \min}$ ①	$C_r$	$C_{or}$	$C_r$	$C_{or}$	grease lubrication			oil lubrication	
5S-7000U	10	26	8	0.3	0.15	5.00	1.62	510	165	2.54	259	52 600	70 100	
5S-7001U	12	28	8	0.3	0.15	5.45	1.90	555	193	2.84	289	45 700	60 900	
5S-7002U	15	32	9	0.3	0.15	6.15	2.38	625	242	3.40	350	39 900	53 100	
5S-7003U	17	35	10	0.3	0.15	7.65	2.92	780	298	4.45	455	36 000	48 000	
5S-7004U	20	42	12	0.6	0.3	10.3	4.25	1 050	430	6.55	670	29 700	39 600	
5S-7005U	25	47	12	0.6	0.3	11.3	5.10	1 150	520	7.65	780	26 000	34 700	
5S-7006U	30	55	13	1	0.6	14.5	7.05	1 480	715	10.7	1 090	21 800	29 000	
5S-7007U	35	62	14	1	0.6	18.3	9.30	1 870	950	13.2	1 340	19 300	25 700	
5S-7008U	40	68	15	1	0.6	19.5	10.7	1 990	1 090	14.8	1 510	17 400	23 100	
5S-7009U	45	75	16	1	0.6	23.1	13.0	2 360	1 320	18.4	1 870	15 600	20 800	
5S-7010U	50	80	16	1	0.6	24.5	14.6	2 500	1 490	20.5	2 090	14 400	19 200	
5S-7011U	55	90	18	1.1	0.6	32.5	19.2	3 300	1 960	26.3	2 680	12 900	17 200	
5S-7012U	60	95	18	1.1	0.6	33.0	20.5	3 350	2 090	27.7	2 830	12 100	16 100	
5S-7013U	65	100	18	1.1	0.6	35.0	22.8	3 550	2 320	30.5	3 100	11 400	15 100	
5S-7014U	70	110	20	1.1	0.6	44.0	28.6	4 500	2 920	40.0	4 100	10 400	13 900	
5S-7015U	75	115	20	1.1	0.6	45.0	30.5	4 600	3 100	42.0	4 300	9 900	13 100	
5S-7016U	80	125	22	1.1	0.6	55.0	37.0	5 600	3 750	50.5	5 150	9 100	12 200	
5S-7017U	85	130	22	1.1	0.6	56.5	39.0	5 750	3 950	53.0	5 400	8 700	11 600	
5S-7018U	90	140	24	1.5	1	67.5	46.0	6 850	4 700	64.5	6 600	8 200	10 900	
5S-7019U	95	145	24	1.5	1	69.0	48.5	7 050	4 950	68.0	6 900	7 800	10 400	
5S-7020U	100	150	24	1.5	1	70.5	51.0	7 200	5 200	71.0	7 250	7 500	10 000	
5S-7021U	105	160	26	2	1	82.5	59.5	8 400	6 050	81.0	8 300	7 100	9 400	
5S-7022U	110	170	28	2	1	95.0	67.5	9 650	6 900	95.0	9 700	6 700	8 900	
5S-7024U	120	180	28	2	1	96.5	71.5	9 850	7 300	99.5	10 200	6 200	8 300	
5S-7026U	130	200	33	2	1	121	91.0	12 300	9 300	126	12 900	5 700	7 600	
5S-7028U	140	210	33	2	1	123	96.0	12 600	9 800	130	13 300	5 300	7 100	

① Minimum allowable value for corner radius dimension  $r$  or  $r_1$ .



**Dynamic equivalent radial load**  $P_r = X F_r + Y F_a$

e	Single row / Tandem		Back-to-back / Face-to-face					
	$F_a / F_r \leq e$	$F_a / F_r > e$	$F_a / F_r \leq e$	$F_a / F_r > e$	$F_a / F_r \leq e$	$F_a / F_r > e$		
	X	Y	X	Y	X	Y		
0.8	1	0	0.39	0.76	1	0.78	0.63	1.24

**Static equivalent radial load**  $P_{or} = X_o F_r + Y_o F_a$

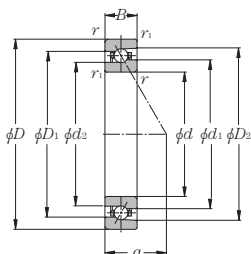
Single row / Tandem		Back-to-back / Face-to-face	
$X_o$	$Y_o$	$X_o$	$Y_o$
0.5	0.33	1	0.66

When  $P_{or} < F_r$  with single-row or tandem arrangement,  $P_{or} = F_r$ .

Load center mm	Internal free space cm <sup>3</sup> Single-row (approx.)	Mass kg Single-row (approx.)	Reference dimensions mm				Abutment and fillet dimensions mm					Part number
			$d_1$	$d_2$	$D_1$	$D_2$	$d_a$ min	$D_a$ max	$D_b$ max	$r_{as}$ max	$r_{1as}$ max	
9.2	0.9	0.017	15.2	14.0	20.4	22.7	12.5	23.5	24.8	0.3	0.15	5S-7000U
10.0	1.0	0.018	17.9	16.7	23.1	25.5	14.5	25.5	26.8	0.3	0.15	5S-7001U
11.3	1.3	0.027	20.9	19.7	26.1	28.6	17.5	29.5	30.8	0.3	0.15	5S-7002U
12.6	1.8	0.033	23.0	21.6	29.0	31.9	19.5	32.5	33.8	0.3	0.15	5S-7003U
15.2	2.9	0.060	28.1	26.4	34.9	38.3	24.5	37.5	39.5	0.6	0.3	5S-7004U
16.5	3.3	0.071	32.6	30.9	39.4	42.8	29.5	42.5	44.5	0.6	0.3	5S-7005U
19.0	4.8	0.10	39.2	37.3	46.9	50.6	35.5	49.5	50.5	1	0.6	5S-7006U
21.1	6.3	0.13	44.2	42.2	52.8	56.9	40.5	56.5	57.5	1	0.6	5S-7007U
23.2	7.4	0.17	49.7	47.7	58.3	62.4	45.5	62.5	63.5	1	0.6	5S-7008U
25.4	9.4	0.21	55.3	53.0	64.7	69.3	50.5	69.5	70.5	1	0.6	5S-7009U
26.9	11	0.23	60.3	58.0	69.7	74.3	55.5	74.5	75.5	1	0.6	5S-7010U
30.1	16	0.33	66.9	64.3	78.1	83.5	62	83	85.5	1	0.6	5S-7011U
31.5	17	0.36	71.9	69.3	83.1	88.5	67	88	90.5	1	0.6	5S-7012U
32.9	18	0.38	76.9	74.3	88.1	93.4	72	93	95.5	1	0.6	5S-7013U
36.1	24	0.53	83.6	80.5	96.4	102.6	77	103	105.5	1	0.6	5S-7014U
37.6	26	0.56	88.6	85.5	101.4	107.6	82	108	110.5	1	0.6	5S-7015U
40.8	34	0.74	95.2	91.7	109.8	116.8	87	118	120.5	1	0.6	5S-7016U
42.2	36	0.78	100.2	96.7	114.8	121.8	92	123	125.5	1	0.6	5S-7017U
45.4	47	1.00	106.9	103.0	123.2	131.0	98.5	131.5	134.5	1.5	1	5S-7018U
46.8	49	1.04	111.9	108.0	128.2	136.0	103.5	136.5	139.5	1.5	1	5S-7019U
48.3	51	1.09	116.9	113.0	133.2	141.0	108.5	141.5	144.5	1.5	1	5S-7020U
51.5	70	1.34	123.5	119.2	141.5	150.1	115	150	154.5	2	1	5S-7021U
54.6	83	1.69	130.2	125.4	149.9	159.3	120	160	164.5	2	1	5S-7022U
57.5	90	1.80	140.2	135.4	159.9	169.2	130	170	174.5	2	1	5S-7024U
64.4	131	2.80	153.9	148.5	176.2	186.9	140	190	194.5	2	1	5S-7026U
67.3	144	2.90	164.0	158.7	186.3	197.0	150	200	204.5	2	1	5S-7028U

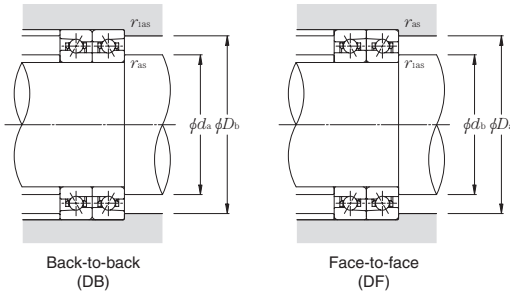
## ULTAGE High-speed angular contact ball bearings (steel ball type) 2LA-HSE9U series

Contact angle  $15^\circ$   $d$  50~170mm



Part number	Boundary dimensions					Basic load ratings				Static axial load capacity		Factor	Limiting speed	
	mm					dynamic		static		kN	kgf		min <sup>-1</sup>	
	d	D	B	r <sub>s</sub> min <sup>①</sup>	r <sub>1s</sub> min <sup>①</sup>	C <sub>r</sub>	C <sub>or</sub>	C <sub>r</sub>	C <sub>or</sub>				grease lubrication	oil lubrication
2LA-HSE910UC	50	72	12	0.6	0.3	11.0	8.1	1 120	830	11.8	1 210	10.9	21 800	34 600
2LA-HSE911UC	55	80	13	1	0.6	13.7	10.1	1 390	1 030	14.8	1 510	10.8	19 700	31 300
2LA-HSE912UC	60	85	13	1	0.6	14.2	11.1	1 450	1 130	16.2	1 660	10.9	18 300	29 100
2LA-HSE913UC	65	90	13	1	0.6	14.3	11.6	1 460	1 180	17.0	1 740	11.0	17 200	27 200
2LA-HSE914UC	70	100	16	1	0.6	20.9	16.5	2 140	1 680	24.2	2 470	10.9	15 600	24 800
2LA-HSE915UC	75	105	16	1	0.6	21.8	18.0	2 220	1 830	26.3	2 690	10.9	14 800	23 400
2LA-HSE916UC	80	110	16	1	0.6	22.0	18.8	2 240	1 910	27.5	2 810	11.0	14 000	22 200
2LA-HSE917UC	85	120	18	1.1	0.6	29.8	24.8	3 050	2 520	36.0	3 700	10.9	13 000	20 600
2LA-HSE918UC	90	125	18	1.1	0.6	31.0	26.8	3 150	2 740	39.0	4 000	10.9	12 400	19 600
2LA-HSE919UC	95	130	18	1.1	0.6	31.5	27.9	3 200	2 850	40.5	4 150	11.0	11 800	18 800
2LA-HSE920UC	100	140	20	1.1	0.6	36.5	32.5	3 700	3 350	48.0	4 900	11.0	11 100	17 600
2LA-HSE921UC	105	145	20	1.1	0.6	37.0	34.0	3 750	3 450	50.0	5 100	11.0	10 600	16 900
2LA-HSE922UC	110	150	20	1.1	0.6	37.5	35.5	3 800	3 600	51.0	5 250	11.1	10 200	16 200
2LA-HSE924UC	120	165	22	1.1	0.6	48.0	45.0	4 850	4 600	66.0	6 750	11.0	9 300	14 800
2LA-HSE926UC	130	180	24	1.5	1	59.0	56.0	6 050	5 700	81.5	8 350	11.0	8 600	13 600
2LA-HSE928UC	140	190	24	1.5	1	59.5	58.0	6 050	5 950	85.0	8 700	11.0	8 100	12 800
2LA-HSE930UC	150	210	28	2	1	79.5	77.0	8 100	7 850	112	11 500	10.9	7 400	11 700
2LA-HSE932UC	160	220	28	2	1	80.0	80.5	8 200	8 200	117	12 000	11.0	7 000	11 100
2LA-HSE934UC	170	230	28	2	1	81.0	83.5	8 250	8 500	122	12 500	11.1	6 700	10 600

① Minimum allowable value for corner radius dimension  $r$  or  $r_1$ .



### Dynamic equivalent radial load

$$P_r = X F_r + Y F_a$$

$i \cdot f_0 \cdot F_a / C_{Or}$	$e$	Single row / Tandem				Back-to-back / Face-to-face			
		$F_d / F_r \leq e$		$F_d / F_r > e$		$F_d / F_r \leq e$		$F_d / F_r > e$	
		X	Y	X	Y	X	Y	X	Y
0.178	0.35			1.57		1.76		2.56	
0.357	0.36			1.53		1.71		2.48	
0.714	0.38			1.46		1.64		2.38	
1.07	0.4			1.42		1.59		2.31	
1.43	0.41	1	0	1.38	1	1.55	0.72	2.25	
2.14	0.43			1.33		1.49		2.16	
3.57	0.44			1.25		1.4		2.03	
5.35	0.47			1.18		1.32		1.92	
7.14	0.49			1.13		1.26		1.83	

### Static equivalent radial load

$$P_{Or} = X_0 F_r + Y_0 F_a$$

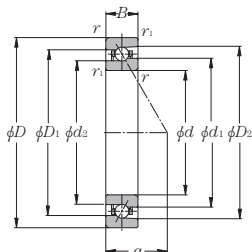
Single row / Tandem		Back-to-back / Face-to-face	
$X_0$	$Y_0$	$X_0$	$Y_0$
0.52	0.54	1.04	1.08

When  $P_{Or} < P_r$  with single-row or tandem arrangement,  $P_{Or} = P_r$ .

Load center mm	Internal free space cm <sup>3</sup>	Mass kg	Reference dimensions				Abutment and fillet dimensions					
			mm				mm					
			$d_1$	$d_2$	$D_1$	$D_2$	$d_a$ min	$d_b$ min	$D_a$ max	$D_b$ max	$r_{as}$ max	$r_{1as}$ max
14.2	6.0	0.13	57.6	56.6	64.4	66.8	54.5	52.5	67.5	69.5	0.6	0.3
15.6	7.7	0.18	63.6	62.4	71.4	74.1	60.5	59.5	74.5	75.5	1	0.6
16.3	8.3	0.20	68.6	67.4	76.4	79.1	65.5	64.5	79.5	80.5	1	0.6
17.0	8.9	0.21	73.6	72.4	81.4	84.1	70.5	69.5	84.5	85.5	1	0.6
19.5	14	0.34	80.1	78.6	89.8	93.2	75.5	74.5	94.5	95.5	1	0.6
20.1	15	0.36	85.1	83.6	94.8	98.2	80.5	79.5	99.5	100.5	1	0.6
20.8	16	0.38	90.1	88.6	99.8	103.2	85.5	84.5	104.5	105.5	1	0.6
22.8	22	0.54	96.8	94.9	108.2	112.3	92	89.5	113	115.5	1	0.6
23.5	23	0.56	101.8	99.9	113.2	117.3	97	94.5	118	120.5	1	0.6
24.2	24	0.59	106.8	104.9	118.2	122.3	102	99.5	123	125.5	1	0.6
26.2	32	0.82	113.8	111.7	126.2	130.7	107	104.5	133	135.5	1	0.6
26.9	33	0.85	118.8	116.7	131.2	135.7	112	109.5	138	140.5	1	0.6
27.5	35	0.88	123.8	121.7	136.2	140.7	117	114.5	143	145.5	1	0.6
30.2	47	1.20	135.4	133.0	149.6	154.8	127	124.5	158	160.5	1	0.6
32.9	62	1.56	146.9	144.2	163.1	168.9	138.5	135.5	171.5	174.5	1.5	1
34.3	66	1.66	156.9	154.2	173.1	178.9	148.5	145.5	181.5	184.5	1.5	1
38.3	99	2.58	170.5	167.3	189.5	196.4	160	155.5	200	204.5	2	1
39.6	105	2.71	180.5	177.3	199.5	206.3	170	165.5	210	214.5	2	1
41.0	111	2.84	190.5	187.3	209.5	216.3	180	175.5	220	224.5	2	1

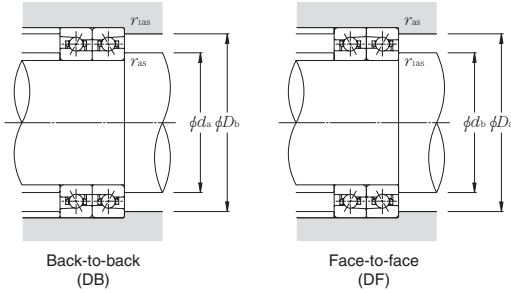
## ULTAGE High-speed angular contact ball bearings (steel ball type) 2LA-HSE9U series

Contact angle  $20^\circ$   $d$  50~170mm



Part number	Boundary dimensions					Basic load ratings				Static axial load capacity		Limiting speed	
	mm					dynamic	static	dynamic	static	kN	kgf	min <sup>-1</sup>	
	d	D	B	r <sub>s</sub> min <sup>①</sup>	r <sub>rs</sub> min <sup>①</sup>	C <sub>r</sub>	C <sub>or</sub>	C <sub>r</sub>	C <sub>or</sub>			grease lubrication	oil lubrication
2LA-HSE910U	50	72	12	0.6	0.3	10.7	7.95	1 090	810	13.2	1 350	23 100	37 200
2LA-HSE911U	55	80	13	1	0.6	13.3	9.90	1 360	1 010	16.5	1 690	20 800	33 600
2LA-HSE912U	60	85	13	1	0.6	13.8	10.8	1 410	1 100	18.1	1 850	19 400	31 300
2LA-HSE913U	65	90	13	1	0.6	13.9	11.3	1 420	1 150	18.9	1 930	18 200	29 300
2LA-HSE914U	70	100	16	1	0.6	20.4	16.1	2 080	1 640	26.9	2 750	16 600	26 700
2LA-HSE915U	75	105	16	1	0.6	21.2	17.5	2 160	1 790	29.4	3 000	15 600	25 200
2LA-HSE916U	80	110	16	1	0.6	21.4	18.3	2 190	1 870	30.0	3 100	14 800	23 900
2LA-HSE917U	85	120	18	1.1	0.6	29.1	24.2	2 960	2 470	40.0	4 100	13 700	22 100
2LA-HSE918U	90	125	18	1.1	0.6	30.0	26.2	3 100	2 670	43.5	4 450	13 100	21 100
2LA-HSE919U	95	130	18	1.1	0.6	30.5	27.3	3 100	2 780	45.5	4 650	12 500	20 200
2LA-HSE920U	100	140	20	1.1	0.6	35.5	32.0	3 600	3 250	53.0	5 450	11 700	18 900
2LA-HSE921U	105	145	20	1.1	0.6	36.0	33.0	3 650	3 400	55.0	5 650	11 300	18 200
2LA-HSE922U	110	150	20	1.1	0.6	36.5	34.5	3 700	3 500	57.0	5 850	10 800	17 500
2LA-HSE924U	120	165	22	1.1	0.6	46.5	44.0	4 750	4 500	74.0	7 550	9 900	15 900
2LA-HSE926U	130	180	24	1.5	1	57.5	54.5	5 850	5 550	91.0	9 300	9 100	14 600
2LA-HSE928U	140	190	24	1.5	1	58.0	57.0	5 900	5 800	95.0	9 700	8 500	13 800
2LA-HSE930U	150	210	28	2	1	77.5	75.5	7 900	7 700	125	12 800	7 800	12 600
2LA-HSE932U	160	220	28	2	1	78.0	78.5	7 950	8 000	131	13 400	7 400	11 900
2LA-HSE934U	170	230	28	2	1	79.0	81.5	8 050	8 300	136	13 900	7 000	11 300

① Minimum allowable value for corner radius dimension  $r$  or  $r_1$ .



**Dynamic equivalent radial load**  $P_r = X F_r + Y F_a$

e	Single row / Tandem				Back-to-back / Face-to-face			
	$F_a / F_r \leq e$		$F_a / F_r > e$		$F_a / F_r \leq e$		$F_a / F_r > e$	
	X	Y	X	Y	X	Y	X	Y
0.57	1	0	0.43	1	1	1.09	0.7	1.63

**Static equivalent radial load**  $P_{or} = X_o F_r + Y_o F_a$

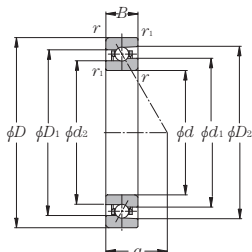
Single row / Tandem		Back-to-back / Face-to-face	
$X_o$	$Y_o$	$X_o$	$Y_o$
0.5	0.42	1	0.84

When  $P_{or} < F_r$  with single-row or tandem arrangement,  $P_{or} = F_r$ .

Load center mm	Internal free space cm <sup>3</sup> Single-row (approx.)	Mass kg Single-row (approx.)	Reference dimensions mm				Abutment and fillet dimensions mm					
			$d_1$	$d_2$	$D_1$	$D_2$	$d_a$ min	$d_b$ min	$D_a$ max	$D_b$ max	$r_{as}$ max	$r_{1as}$ max
17.2	6.0	0.13	57.6	56.6	64.4	66.8	54.5	52.5	67.5	69.5	0.6	0.3
18.9	7.7	0.18	63.6	62.4	71.4	74.1	60.5	59.5	74.5	75.5	1	0.6
19.8	8.3	0.20	68.6	67.4	76.4	79.1	65.5	64.5	79.5	80.5	1	0.6
20.7	8.9	0.21	73.6	72.4	81.4	84.0	70.5	69.5	84.5	85.5	1	0.6
23.6	14	0.34	80.1	78.6	89.8	93.2	75.5	74.5	94.5	95.5	1	0.6
24.5	15	0.36	85.1	83.6	94.8	98.2	80.5	79.5	99.5	100.5	1	0.6
25.4	16	0.38	90.1	88.6	99.8	103.2	85.5	84.5	104.5	105.5	1	0.6
27.8	22	0.54	96.8	94.9	108.2	112.3	92	89.5	113	115.5	1	0.6
28.7	23	0.56	101.8	99.9	113.2	117.3	97	94.5	118	120.5	1	0.6
29.6	24	0.59	106.8	104.9	118.2	122.3	102	99.5	123	125.5	1	0.6
32.0	32	0.82	113.8	111.7	126.2	130.6	107	104.5	133	135.5	1	0.6
32.9	33	0.85	118.8	116.7	131.2	135.6	112	109.5	138	140.5	1	0.6
33.8	35	0.88	123.8	121.7	136.2	140.6	117	114.5	143	145.5	1	0.6
37.1	47	1.20	135.4	133.0	149.6	154.7	127	124.5	158	160.5	1	0.6
40.4	62	1.56	146.9	144.2	163.1	168.9	138.5	135.5	171.5	174.5	1.5	1
42.2	66	1.66	156.9	154.2	173.1	178.8	148.5	145.5	181.5	184.5	1.5	1
47.0	99	2.58	170.5	167.3	189.5	196.3	160	155.5	200	204.5	2	1
48.8	105	2.71	180.5	177.3	199.5	206.3	170	165.5	210	214.5	2	1
50.6	111	2.84	190.5	187.3	209.5	216.3	180	175.5	220	224.5	2	1

## ULTAGE High-speed angular contact ball bearings (steel ball type) 2LA-HSE9U series

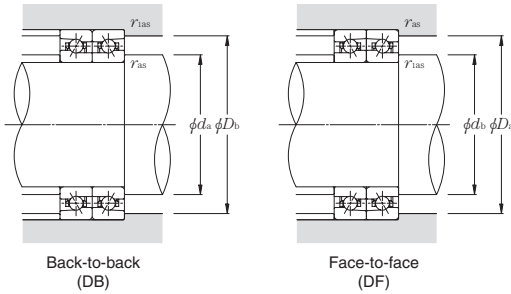
Contact angle 25°  $d$  50~170mm



Part number	Boundary dimensions					Basic load ratings				Static axial load capacity		Limiting speed	
	mm					dynamic		static		kN	kgf	min <sup>-1</sup>	
	$d$	$D$	$B$	$r_{rs \text{ min}}$ ①	$r_{rs \text{ min}}$ ①	$C_r$	$C_{or}$	$C_r$	$C_{or}$			grease lubrication	oil lubrication
2LA-HSE910UAD	50	72	12	0.6	0.3	10.3	7.70	1 050	785	14.8	1 510	20 500	32 100
2LA-HSE911UAD	55	80	13	1	0.6	12.9	9.60	1 310	980	18.4	1 880	18 500	29 000
2LA-HSE912UAD	60	85	13	1	0.6	13.3	10.5	1 360	1 070	20.2	2 060	17 200	27 000
2LA-HSE913UAD	65	90	13	1	0.6	13.5	11.0	1 370	1 120	21.1	2 160	16 100	25 300
2LA-HSE914UAD	70	100	16	1	0.6	19.7	15.6	2 010	1 590	29.9	3 050	14 700	23 000
2LA-HSE915UAD	75	105	16	1	0.6	20.5	17.0	2 090	1 730	32.0	3 300	13 900	21 700
2LA-HSE916UAD	80	110	16	1	0.6	20.7	17.7	2 110	1 810	33.5	3 450	13 200	20 600
2LA-HSE917UAD	85	120	18	1.1	0.6	28.1	23.4	2 860	2 390	45.0	4 600	12 200	19 100
2LA-HSE918UAD	90	125	18	1.1	0.6	29.2	25.4	2 980	2 590	48.5	4 950	11 600	18 200
2LA-HSE919UAD	95	130	18	1.1	0.6	29.5	26.4	3 000	2 690	50.5	5 200	11 100	17 400
2LA-HSE920UAD	100	140	20	1.1	0.6	34.5	31.0	3 500	3 150	59.0	6 050	10 400	16 300
2LA-HSE921UAD	105	145	20	1.1	0.6	34.5	32.0	3 550	3 300	61.5	6 300	10 000	15 700
2LA-HSE922UAD	110	150	20	1.1	0.6	35.0	33.5	3 600	3 400	64.0	6 550	9 600	15 100
2LA-HSE924UAD	120	165	22	1.1	0.6	45.0	42.5	4 600	4 350	82.0	8 400	8 800	13 700
2LA-HSE926UAD	130	180	24	1.5	1	55.5	53.0	5 700	5 400	101	10 400	8 100	12 600
2LA-HSE928UAD	140	190	24	1.5	1	56.0	55.0	5 700	5 600	105	10 800	7 600	11 900
2LA-HSE930UAD	150	210	28	2	1	75.0	73.0	7 650	7 450	140	14 300	6 900	10 900
2LA-HSE932UAD	160	220	28	2	1	75.5	76.0	7 700	7 750	146	14 900	6 600	10 300
2LA-HSE934UAD	170	230	28	2	1	76.0	79.0	7 750	8 050	152	15 500	6 200	9 800

① Minimum allowable value for corner radius dimension  $r$  or  $r_1$ .





**Dynamic equivalent radial load**  $P_r = X F_r + Y F_a$

e	Single row / Tandem				Back-to-back / Face-to-face			
	$F_a / F_r \leq e$		$F_a / F_r > e$		$F_a / F_r \leq e$		$F_a / F_r > e$	
	X	Y	X	Y	X	Y	X	Y
0.68	1	0	0.41	0.87	1	0.92	0.67	1.41

**Static equivalent radial load**  $P_{or} = X_0 F_r + Y_0 F_a$

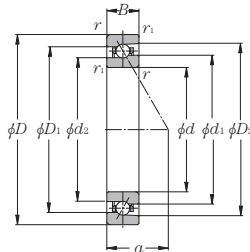
Single row / Tandem		Back-to-back / Face-to-face	
$X_0$	$Y_0$	$X_0$	$Y_0$
0.5	0.38	1	0.76

When  $P_{or} < F_r$  with single-row or tandem arrangement,  $P_{or} = F_r$ .

Load center mm	Internal free space cm <sup>3</sup> Single-row (approx.)	Mass kg Single-row (approx.)	Reference dimensions mm				Abutment and fillet dimensions mm					
			$d_1$	$d_2$	$D_1$	$D_2$	$d_a$ min	$d_b$ min	$D_a$ max	$D_b$ max	$r_{as}$ max	$r_{1as}$ max
20.3	6.0	0.13	57.6	56.6	64.4	66.7	54.5	52.5	67.5	69.5	0.6	0.3
22.4	7.7	0.18	63.6	62.4	71.4	74.1	60.5	59.5	74.5	75.5	1	0.6
23.5	8.3	0.20	68.6	67.4	76.4	79.0	65.5	64.5	79.5	80.5	1	0.6
24.7	8.9	0.21	73.6	72.4	81.4	84.0	70.5	69.5	84.5	85.5	1	0.6
28.0	14	0.34	80.1	78.6	89.8	93.2	75.5	74.5	94.5	95.5	1	0.6
29.1	15	0.36	85.1	83.6	94.8	98.2	80.5	79.5	99.5	100.5	1	0.6
30.3	16	0.38	90.1	88.6	99.8	103.2	85.5	84.5	104.5	105.5	1	0.6
33.1	22	0.54	96.8	94.9	108.2	112.3	92	89.5	113	115.5	1	0.6
34.2	23	0.56	101.8	99.9	113.2	117.3	97	94.5	118	120.5	1	0.6
35.4	24	0.59	106.8	104.9	118.2	122.3	102	99.5	123	125.5	1	0.6
38.2	32	0.82	113.8	111.7	126.2	130.6	107	104.5	133	135.5	1	0.6
39.3	33	0.85	118.8	116.7	131.2	135.6	112	109.5	138	140.5	1	0.6
40.5	35	0.88	123.8	121.7	136.2	140.6	117	114.5	143	145.5	1	0.6
44.4	47	1.20	135.4	133.0	149.6	154.7	127	124.5	158	160.5	1	0.6
48.4	62	1.56	146.9	144.2	163.1	168.8	138.5	135.5	171.5	174.5	1.5	1
50.7	66	1.66	156.9	154.2	173.1	178.8	148.5	145.5	181.5	184.5	1.5	1
56.3	99	2.58	170.5	167.3	189.5	196.3	160	155.5	200	204.5	2	1
58.6	105	2.71	180.5	177.3	199.5	206.3	170	165.5	210	214.5	2	1
60.9	111	2.84	190.5	187.3	209.5	216.3	180	175.5	220	224.5	2	1

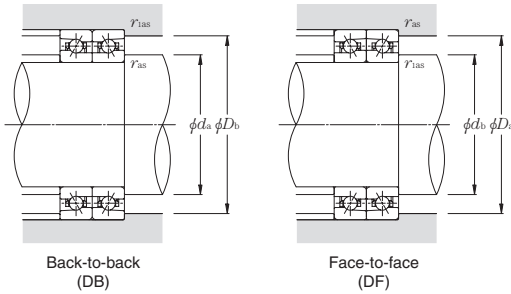
## ULTAGE High-speed angular contact ball bearings (steel ball type) 2LA-HSE0 series

Contact angle 15°  $d$  50~170mm



Part number	Boundary dimensions						Basic load ratings				Static axial load capacity		Factor	Limiting speed	
	mm						dynamic		static		kN	kgf		min <sup>-1</sup>	
	$d$	$D$	$B$	$r_{1s}$ min <sup>①</sup>	$r_{1s}$ min <sup>①</sup>	$C_r$	$C_{or}$	$C_r$	$C_{or}$	grease lubrication				oil lubrication	
2LA-HSE010C	50	80	16	1	0.6	15.9	11.4	1 620	1 160	16.7	1 700	10.4	20 500	32 500	
2LA-HSE011C	55	90	18	1.1	0.6	17.3	13.6	1 760	1 380	19.9	2 030	10.6	18 300	29 100	
2LA-HSE012C	60	95	18	1.1	0.6	18.1	15.0	1 850	1 530	22.0	2 240	10.7	17 200	27 200	
2LA-HSE013C	65	100	18	1.1	0.6	18.4	15.8	1 870	1 610	23.2	2 360	10.8	16 100	25 600	
2LA-HSE014C	70	110	20	1.1	0.6	22.5	19.9	2 290	2 030	29.2	2 980	10.8	14 800	23 400	
2LA-HSE015C	75	115	20	1.1	0.6	23.9	22.4	2 440	2 290	33.0	3 350	10.9	14 000	22 200	
2LA-HSE016C	80	125	22	1.1	0.6	27.4	25.7	2 790	2 620	38.0	3 850	10.9	13 000	20 600	
2LA-HSE017C	85	130	22	1.1	0.6	27.7	26.8	2 830	2 740	39.5	4 000	10.9	12 400	19 600	
2LA-HSE018C	90	140	24	1.5	1	32.0	31.5	3 300	3 200	46.0	4 700	10.9	11 600	18 300	
2LA-HSE019C	95	145	24	1.5	1	32.5	32.5	3 300	3 350	48.0	4 900	11.0	11 100	17 600	
2LA-HSE020C	100	150	24	1.5	1	33.5	35.0	3 450	3 600	51.5	5 250	11.0	10 600	16 900	
2LA-HSE021C	105	160	26	2	1	38.5	40.5	3 950	4 150	60.0	6 100	11.0	10 000	15 900	
2LA-HSE022C	110	170	28	2	1	48.0	49.5	4 900	5 000	72.5	7 400	10.9	9 500	15 100	
2LA-HSE024C	120	180	28	2	1	48.0	51.5	4 900	5 250	75.5	7 700	11.0	8 900	14 100	
2LA-HSE026C	130	200	33	2	1	69.0	71.0	7 050	7 250	104	10 600	10.8	8 100	12 800	
2LA-HSE028C	140	210	33	2	1	71.5	77.0	7 300	7 850	113	11 500	10.9	7 600	12 100	
2LA-HSE030C	150	225	35	2.1	1.1	73.5	83.0	7 500	8 450	122	12 400	11.0	7 100	11 300	
2LA-HSE032C	160	240	38	2.1	1.1	86.0	97.0	8 800	9 850	142	14 500	11.0	6 700	10 600	
2LA-HSE034C	170	260	42	2.1	1.1	99.0	111	10 100	11 300	163	16 700	10.9	6 200	9 800	

① Minimum allowable value for corner radius dimension  $r$  or  $r_1$ .



### Dynamic equivalent radial load

$$P_r = X F_r + Y F_a$$

$i \cdot f_0 \cdot F_a / C_{Or}$	$e$	Single row / Tandem				Back-to-back / Face-to-face			
		$F_d / F_r \leq e$		$F_d / F_r > e$		$F_d / F_r \leq e$		$F_d / F_r > e$	
		X	Y	X	Y	X	Y	X	Y
0.178	0.35			1.57		1.76		2.56	
0.357	0.36			1.53		1.71		2.48	
0.714	0.38			1.46		1.64		2.38	
1.07	0.4			1.42		1.59		2.31	
1.43	0.41	1	0	1.38	1	1.55	0.72	2.25	
2.14	0.43			1.33		1.49		2.16	
3.57	0.44			1.25		1.4		2.03	
5.35	0.47			1.18		1.32		1.92	
7.14	0.49			1.13		1.26		1.83	

### Static equivalent radial load

$$P_{Or} = X_0 F_r + Y_0 F_a$$

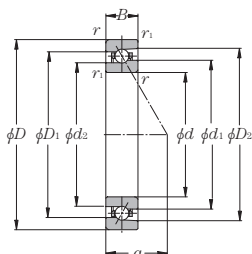
Single row / Tandem		Back-to-back / Face-to-face	
$X_0$	$Y_0$	$X_0$	$Y_0$
0.52	0.54	1.04	1.08

When  $P_{Or} < P_r$  with single-row or tandem arrangement,  $P_{Or} = P_r$ .

Load center mm	Internal free space cm <sup>3</sup>	Mass kg	Reference dimensions				Abutment and fillet dimensions					
			mm				mm					
			$d_1$	$d_2$	$D_1$	$D_2$	$d_a$ min	$d_b$ min	$D_a$ max	$D_b$ max	$r_{as}$ max	$r_{1as}$ max
16.8	12	0.26	60.1	58.6	69.9	73.3	55.5	54.5	74.5	75.5	1	0.6
18.8	16	0.40	67.6	66.2	77.4	80.8	62	59.5	83	85.5	1	0.6
19.5	17	0.42	72.6	71.2	82.4	85.8	67	64.5	88	90.5	1	0.6
20.1	18	0.45	77.6	76.2	87.4	90.8	72	69.5	93	95.5	1	0.6
22.2	24	0.64	84.8	83.0	95.2	99.1	77	74.5	103	105.5	1	0.6
22.8	25	0.68	89.8	88.0	100.2	104.1	82	79.5	108	110.5	1	0.6
24.8	34	0.91	96.8	94.9	108.2	112.5	87	84.5	118	120.5	1	0.6
25.5	35	0.96	101.8	99.9	113.2	117.5	92	89.5	123	125.5	1	0.6
27.5	45	1.25	108.8	106.7	121.2	125.8	98.5	95.5	131.5	134.5	1.5	1
28.2	47	1.30	113.8	111.7	126.2	130.8	103.5	100.5	136.5	139.5	1.5	1
28.9	49	1.36	118.8	116.7	131.2	135.8	108.5	105.5	141.5	144.5	1.5	1
30.9	61	1.73	125.8	123.6	139.2	144.1	115	110.5	150	154.5	2	1
32.9	77	2.13	132.4	129.8	147.6	153.3	120	115.5	160	164.5	2	1
34.2	82	2.28	142.4	139.8	157.6	163.3	130	125.5	170	174.5	2	1
38.8	130	3.40	155.5	152.3	174.5	181.6	140	135.5	190	194.5	2	1
40.1	129	3.68	165.5	162.4	184.5	191.5	150	145.5	200	204.5	2	1
42.8	163	4.46	178.0	174.8	197.0	204.1	162	157	213	218	2	1
46.0	206	5.46	189.5	186.0	210.5	218.2	172	167	228	233	2	1
50.0	272	7.37	203.6	199.8	226.4	234.9	182	177	248	253	2	1

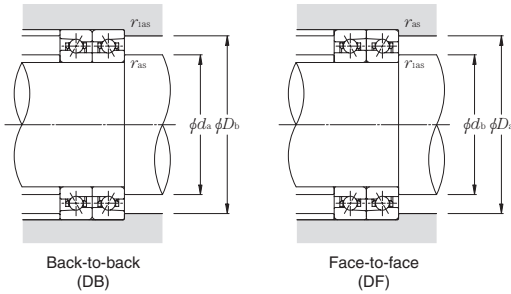
## ULTAGE High-speed angular contact ball bearings (steel ball type) 2LA-HSE0 series

Contact angle 20°  $d$  50~170mm



Part number	Boundary dimensions					Basic load ratings				Static axial load capacity		Limiting speed	
	mm					dynamic		static		kN	kgf	min <sup>-1</sup>	
	d	D	B	r <sub>s</sub> min <sup>①</sup>	r <sub>1s</sub> min <sup>①</sup>	C <sub>r</sub>	C <sub>or</sub>	C <sub>r</sub>	C <sub>or</sub>			grease lubrication	oil lubrication
2LA-HSE010	50	80	16	1	0.6	15.5	11.2	1 580	1 140	18.7	1 900	21 600	34 900
2LA-HSE011	55	90	18	1.1	0.6	16.8	13.3	1 720	1 350	22.2	2 260	19 400	31 300
2LA-HSE012	60	95	18	1.1	0.6	17.6	14.7	1 800	1 490	24.6	2 500	18 200	29 300
2LA-HSE013	65	100	18	1.1	0.6	17.9	15.4	1 830	1 570	25.9	2 640	17 100	27 500
2LA-HSE014	70	110	20	1.1	0.6	21.9	19.4	2 230	1 980	32.5	3 300	15 600	25 200
2LA-HSE015	75	115	20	1.1	0.6	23.3	21.9	2 380	2 230	36.5	3 750	14 800	23 900
2LA-HSE016	80	125	22	1.1	0.6	26.7	25.1	2 720	2 560	42.0	4 300	13 700	22 100
2LA-HSE017	85	130	22	1.1	0.6	27.0	26.2	2 760	2 670	44.0	4 500	13 100	21 100
2LA-HSE018	90	140	24	1.5	1	31.5	30.5	3 200	3 150	51.5	5 250	12 200	19 700
2LA-HSE019	95	145	24	1.5	1	31.5	32.0	3 250	3 250	53.5	5 450	11 700	18 900
2LA-HSE020	100	150	24	1.5	1	33.0	34.5	3 350	3 500	57.5	5 850	11 300	18 200
2LA-HSE021	105	160	26	2	1	37.5	39.5	3 850	4 050	66.5	6 800	10 600	17 100
2LA-HSE022	110	170	28	2	1	46.5	48.0	4 750	4 900	80.5	8 200	10 000	16 200
2LA-HSE024	120	180	28	2	1	47.0	50.0	4 800	5 100	84.0	8 600	9 400	15 100
2LA-HSE026	130	200	33	2	1	67.5	69.5	6 900	7 100	116	11 900	8 500	13 800
2LA-HSE028	140	210	33	2	1	70.0	75.0	7 100	7 650	126	12 800	8 000	13 000
2LA-HSE030	150	225	35	2.1	1.1	72.0	81.0	7 300	8 250	136	13 900	7 500	12 100
2LA-HSE032	160	240	38	2.1	1.1	84.0	94.5	8 550	9 650	159	16 200	7 000	11 300
2LA-HSE034	170	260	42	2.1	1.1	96.5	108	9 850	11 100	182	18 600	6 500	10 600

① Minimum allowable value for corner radius dimension  $r$  or  $r_1$ .



**Dynamic equivalent radial load**  $P_r = X F_r + Y F_a$

e	Single row / Tandem				Back-to-back / Face-to-face			
	$F_a / F_r \leq e$		$F_a / F_r > e$		$F_a / F_r \leq e$		$F_a / F_r > e$	
	X	Y	X	Y	X	Y	X	Y
0.57	1	0	0.43	1	1	1.09	0.7	1.63

**Static equivalent radial load**  $P_{or} = X_0 F_r + Y_0 F_a$

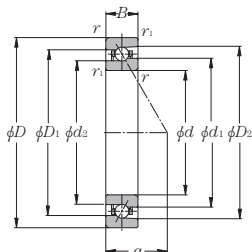
Single row / Tandem		Back-to-back / Face-to-face	
$X_0$	$Y_0$	$X_0$	$Y_0$
0.5	0.42	1	0.84

When  $P_{or} < F_r$  with single-row or tandem arrangement,  $P_{or} = F_r$ .

Load center mm	Internal free space cm <sup>3</sup>	Mass kg	Reference dimensions				Abutment and fillet dimensions					
			mm				mm					
a	Single-row (approx.)	Single-row (approx.)	d1	d2	D1	D2	da min	db min	Da max	Db max	ras max	r1as max
19.9	12	0.26	60.1	58.6	69.9	73.2	55.5	54.5	74.5	75.5	1	0.6
22.3	16	0.40	67.6	66.2	77.4	80.8	62	59.5	83	85.5	1	0.6
23.2	17	0.42	72.6	71.2	82.4	85.8	67	64.5	88	90.5	1	0.6
24.1	18	0.45	77.6	76.2	87.4	90.8	72	69.5	93	95.5	1	0.6
26.5	24	0.64	84.8	83.0	95.2	99.1	77	74.5	103	105.5	1	0.6
27.4	25	0.68	89.8	88.0	100.2	104.1	82	79.5	108	110.5	1	0.6
29.8	34	0.91	96.8	94.9	108.2	112.5	87	84.5	118	120.5	1	0.6
30.7	35	0.96	101.8	99.9	113.2	117.4	92	89.5	123	125.5	1	0.6
33.1	45	1.25	108.8	106.7	121.2	125.8	98.5	95.5	131.5	134.5	1.5	1
34.0	47	1.30	113.8	111.7	126.2	130.8	103.5	100.5	136.5	139.5	1.5	1
34.9	49	1.36	118.8	116.7	131.2	135.8	108.5	105.5	141.5	144.5	1.5	1
37.3	61	1.73	125.8	123.6	139.2	144.1	115	110.5	150	154.5	2	1
39.7	77	2.13	132.4	129.8	147.6	153.2	120	115.5	160	164.5	2	1
41.5	82	2.28	142.4	139.8	157.6	163.2	130	125.5	170	174.5	2	1
46.8	130	3.40	155.5	152.3	174.5	181.5	140	135.5	190	194.5	2	1
48.6	129	3.68	165.5	162.4	184.5	191.5	150	145.5	200	204.5	2	1
51.9	163	4.46	178.0	174.8	197.0	204.0	162	157	213	218	2	1
55.7	206	5.46	189.5	186.0	210.5	218.2	172	167	228	233	2	1
60.4	272	7.37	203.6	199.8	226.4	234.9	182	177	248	253	2	1

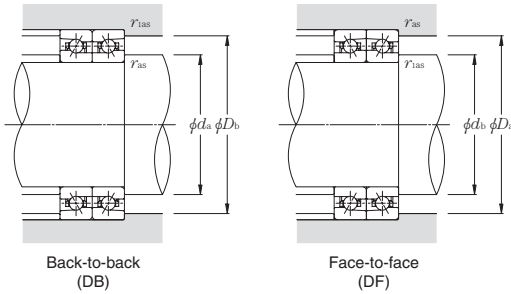
## ULTAGE High-speed angular contact ball bearings (steel ball type) 2LA-HSE0 series

Contact angle 25°  $d$  50~170mm



Part number	Boundary dimensions						Basic load ratings				Static axial load capacity		Limiting speed	
	mm						dynamic		static		kN	kgf	min <sup>-1</sup>	
	d	D	B	r <sub>s</sub> min <sup>①</sup>	r <sub>1s</sub> min <sup>①</sup>	C <sub>r</sub>	C <sub>or</sub>	C <sub>r</sub>	C <sub>or</sub>	grease lubrication			oil lubrication	
2LA-HSE010AD	50	80	16	1	0.6	15.0	10.8	1 530	1 100	20.9	2 130	19 200	30 100	
2LA-HSE011AD	55	90	18	1.1	0.6	16.3	12.9	1 660	1 310	24.8	2 530	17 200	27 000	
2LA-HSE012AD	60	95	18	1.1	0.6	17.1	14.2	1 740	1 450	27.4	2 800	16 100	25 300	
2LA-HSE013AD	65	100	18	1.1	0.6	17.3	14.9	1 770	1 520	28.9	2 940	15 100	23 700	
2LA-HSE014AD	70	110	20	1.1	0.6	21.2	18.8	2 160	1 920	36.5	3 700	13 900	21 700	
2LA-HSE015AD	75	115	20	1.1	0.6	22.5	21.2	2 300	2 160	41.0	4 200	13 200	20 600	
2LA-HSE016AD	80	125	22	1.1	0.6	25.8	24.3	2 630	2 480	47.0	4 800	12 200	19 100	
2LA-HSE017AD	85	130	22	1.1	0.6	26.1	25.4	2 660	2 590	49.0	5 000	11 600	18 200	
2LA-HSE018AD	90	140	24	1.5	1	30.5	29.7	3 100	3 050	57.5	5 850	10 900	17 000	
2LA-HSE019AD	95	145	24	1.5	1	30.5	31.0	3 150	3 150	60.0	6 100	10 400	16 300	
2LA-HSE020AD	100	150	24	1.5	1	31.5	33.0	3 250	3 400	64.0	6 550	10 000	15 700	
2LA-HSE021AD	105	160	26	2	1	36.5	38.5	3 700	3 900	74.5	7 600	9 400	14 800	
2LA-HSE022AD	110	170	28	2	1	45.0	46.5	4 600	4 750	90.0	9 150	8 900	14 000	
2LA-HSE024AD	120	180	28	2	1	45.5	48.5	4 650	4 950	94.0	9 550	8 300	13 000	
2LA-HSE026AD	130	200	33	2	1	65.0	67.5	6 650	6 850	130	13 200	7 600	11 900	
2LA-HSE028AD	140	210	33	2	1	67.5	73.0	6 900	7 400	141	14 300	7 100	11 200	
2LA-HSE030AD	150	225	35	2.1	1.1	69.5	78.5	7 050	8 000	151	15 400	6 700	10 400	
2LA-HSE032AD	160	240	38	2.1	1.1	81.0	91.5	8 300	9 350	177	18 000	6 200	9 800	
2LA-HSE034AD	170	260	42	2.1	1.1	93.0	105	9 500	10 700	203	20 700	5 800	9 100	

① Minimum allowable value for corner radius dimension  $r$  or  $r_1$ .



**Dynamic equivalent radial load**  $P_r = X F_r + Y F_a$

e	Single row / Tandem				Back-to-back / Face-to-face			
	$F_a / F_r \leq e$		$F_a / F_r > e$		$F_a / F_r \leq e$		$F_a / F_r > e$	
	X	Y	X	Y	X	Y	X	Y
0.68	1	0	0.41	0.87	1	0.92	0.67	1.41

**Static equivalent radial load**  $P_{or} = X_0 F_r + Y_0 F_a$

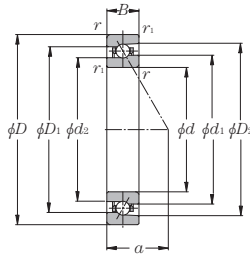
Single row / Tandem		Back-to-back / Face-to-face	
$X_0$	$Y_0$	$X_0$	$Y_0$
0.5	0.38	1	0.76

When  $P_{or} < F_r$  with single-row or tandem arrangement,  $P_{or} = F_r$ .

Load center mm	Internal free space cm <sup>3</sup>	Mass kg	Reference dimensions				Abutment and fillet dimensions					
			mm				mm					
a	Single-row (approx.)	Single-row (approx.)	d <sub>1</sub>	d <sub>2</sub>	D <sub>1</sub>	D <sub>2</sub>	d <sub>a</sub> min	d <sub>b</sub> min	D <sub>a</sub> max	D <sub>b</sub> max	r <sub>as</sub> max	r <sub>1as</sub> max
23.3	12	0.26	60.1	58.6	69.9	73.2	55.5	54.5	74.5	75.5	1	0.6
26.1	16	0.40	67.6	66.2	77.4	80.8	62	59.5	83	85.5	1	0.6
27.2	17	0.42	72.6	71.2	82.4	85.8	67	64.5	88	90.5	1	0.6
28.4	18	0.45	77.6	76.2	87.4	90.8	72	69.5	93	95.5	1	0.6
31.1	24	0.64	84.8	83.0	95.2	99.1	77	74.5	103	105.5	1	0.6
32.3	25	0.68	89.8	88.0	100.2	104.1	82	79.5	108	110.5	1	0.6
35.1	34	0.91	96.8	94.9	108.2	112.5	87	84.5	118	120.5	1	0.6
36.2	35	0.96	101.8	99.9	113.2	117.4	92	89.5	123	125.5	1	0.6
39.0	45	1.25	108.8	106.7	121.2	125.8	98.5	95.5	131.5	134.5	1.5	1
40.2	47	1.30	113.8	111.7	126.2	130.8	103.5	100.5	136.5	139.5	1.5	1
41.3	49	1.36	118.8	116.7	131.2	135.8	108.5	105.5	141.5	144.5	1.5	1
44.1	61	1.73	125.8	123.6	139.2	144.1	115	110.5	150	154.5	2	1
46.9	77	2.13	132.4	129.8	147.6	153.2	120	115.5	160	164.5	2	1
49.2	82	2.28	142.4	139.8	157.6	163.2	130	125.5	170	174.5	2	1
55.3	130	3.40	155.5	152.3	174.5	181.5	140	135.5	190	194.5	2	1
57.6	129	3.68	165.5	162.4	184.5	191.5	150	145.5	200	204.5	2	1
61.5	163	4.46	178.0	174.8	197.0	204.0	162	157	213	218	2	1
66.0	206	5.46	189.5	186.0	210.5	218.2	172	167	228	233	2	1
71.5	272	7.37	203.6	199.8	226.4	234.9	182	177	248	253	2	1

## ULTAGE High-speed angular contact ball bearings (ceramic ball type) 5S-2LA-HSE9U series

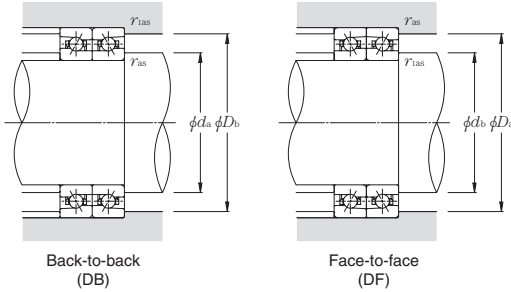
Contact angle 15°  $d$  50~170mm



Part number	Boundary dimensions					Basic load ratings				Static axial load capacity		Factor	Limiting speed	
	mm					dynamic		static		kN	kgf		min <sup>-1</sup>	
	$d$	$D$	$B$	$r_{1s}$ min <sup>①</sup>	$r_{1s}$ min <sup>①</sup>	$C_r$	$C_{or}$	$C_r$	$C_{or}$				grease lubrication	oil lubrication
5S-2LA-HSE910UC	50	72	12	0.6	0.3	11.0	5.65	1 120	575	7.45	760	7.6	25 600	42 400
5S-2LA-HSE911UC	55	80	13	1	0.6	13.7	7.05	1 390	715	9.30	950	7.5	23 100	38 300
5S-2LA-HSE912UC	60	85	13	1	0.6	14.2	7.70	1 450	785	10.1	1 040	7.6	21 500	35 700
5S-2LA-HSE913UC	65	90	13	1	0.6	14.3	8.05	1 460	820	10.6	1 090	7.6	20 100	33 400
5S-2LA-HSE914UC	70	100	16	1	0.6	20.9	11.5	2 140	1 170	15.2	1 560	7.5	18 400	30 400
5S-2LA-HSE915UC	75	105	16	1	0.6	21.8	12.5	2 220	1 270	16.6	1 700	7.6	17 300	28 700
5S-2LA-HSE916UC	80	110	16	1	0.6	22.0	13.0	2 240	1 330	17.3	1 770	7.6	16 400	27 200
5S-2LA-HSE917UC	85	120	18	1.1	0.6	29.8	17.2	3 050	1 750	22.9	2 340	7.5	15 200	25 200
5S-2LA-HSE918UC	90	125	18	1.1	0.6	31.0	18.6	3 150	1 900	24.8	2 530	7.6	14 500	24 100
5S-2LA-HSE919UC	95	130	18	1.1	0.6	31.5	19.4	3 200	1 970	25.8	2 640	7.6	13 900	23 000
5S-2LA-HSE920UC	100	140	20	1.1	0.6	36.5	22.7	3 700	2 310	29.9	3 050	7.6	13 000	21 600
5S-2LA-HSE921UC	105	145	20	1.1	0.6	37.0	23.6	3 750	2 400	31.0	3 200	7.6	12 500	20 700
5S-2LA-HSE922UC	110	150	20	1.1	0.6	37.5	24.5	3 800	2 500	32.0	3 300	7.7	12 000	19 900
5S-2LA-HSE924UC	120	165	22	1.1	0.6	48.0	31.5	4 850	3 200	41.5	4 250	7.6	10 900	18 200
5S-2LA-HSE926UC	130	180	24	1.5	1	59.0	38.5	6 050	3 950	51.0	5 250	7.6	10 100	16 700
5S-2LA-HSE928UC	140	190	24	1.5	1	59.5	40.5	6 050	4 100	53.5	5 500	7.6	9 500	15 700
5S-2LA-HSE930UC	150	210	28	2	1	79.5	53.5	8 100	5 450	71.5	7 300	7.6	8 700	14 400
5S-2LA-HSE932UC	160	220	28	2	1	80.0	55.5	8 200	5 700	74.5	7 600	7.6	8 200	13 600
5S-2LA-HSE934UC	170	230	28	2	1	81.0	58.0	8 250	5 900	77.0	7 900	7.7	7 800	12 900

① Minimum allowable value for corner radius dimension  $r$  or  $r_1$ .





**Dynamic equivalent radial load**

$$P_r = X F_r + Y F_a$$

$i \cdot f_0 \cdot F_a / C_{Or}$	e	Single row / Tandem				Back-to-back / Face-to-face			
		$F_d / F_r \leq e$		$F_d / F_r > e$		$F_d / F_r \leq e$		$F_d / F_r > e$	
		X	Y	X	Y	X	Y	X	Y
0.178	0.35			1.57		1.76		2.56	
0.357	0.36			1.53		1.71		2.48	
0.714	0.38			1.46		1.64		2.38	
1.07	0.4			1.42		1.59		2.31	
1.43	0.41	1	0	1.38	1	1.55	0.72	2.25	
2.14	0.43			1.33		1.49		2.16	
3.57	0.44			1.25		1.4		2.03	
5.35	0.47			1.18		1.32		1.92	
7.14	0.49			1.13		1.26		1.83	

**Static equivalent radial load**

$$P_{Or} = X_0 F_r + Y_0 F_a$$

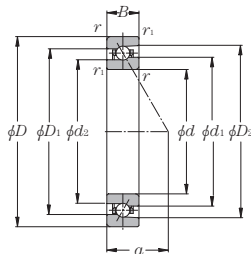
Single row / Tandem		Back-to-back / Face-to-face	
$X_0$	$Y_0$	$X_0$	$Y_0$
0.52	0.54	1.04	1.08

When  $P_{Or} < F_r$  with single-row or tandem arrangement,  $P_{Or} = F_r$ .

Load center mm	Internal free space cm <sup>3</sup>	Mass kg	Reference dimensions				Abutment and fillet dimensions					
			mm				mm					
			$d_1$	$d_2$	$D_1$	$D_2$	$d_a$ min	$d_b$ min	$D_a$ max	$D_b$ max	$r_{as}$ max	$r_{1as}$ max
a												
14.2	6.0	0.12	57.6	56.6	64.4	66.8	54.5	52.5	67.5	69.5	0.6	0.3
15.6	7.7	0.17	63.6	62.4	71.4	74.1	60.5	59.5	74.5	75.5	1	0.6
16.3	8.3	0.18	68.6	67.4	76.4	79.1	65.5	64.5	79.5	80.5	1	0.6
17.0	8.9	0.19	73.6	72.4	81.4	84.1	70.5	69.5	84.5	85.5	1	0.6
19.5	14	0.31	80.1	78.6	89.8	93.2	75.5	74.5	94.5	95.5	1	0.6
20.1	15	0.33	85.1	83.6	94.8	98.2	80.5	79.5	99.5	100.5	1	0.6
20.8	16	0.34	90.1	88.6	99.8	103.2	85.5	84.5	104.5	105.5	1	0.6
22.8	22	0.48	96.8	94.9	108.2	112.3	92	89.5	113	115.5	1	0.6
23.5	23	0.51	101.8	99.9	113.2	117.3	97	94.5	118	120.5	1	0.6
24.2	24	0.53	106.8	104.9	118.2	122.3	102	99.5	123	125.5	1	0.6
26.2	32	0.74	113.8	111.7	126.2	130.7	107	104.5	133	135.5	1	0.6
26.9	33	0.77	118.8	116.7	131.2	135.7	112	109.5	138	140.5	1	0.6
27.5	35	0.80	123.8	121.7	136.2	140.7	117	114.5	143	145.5	1	0.6
30.2	47	1.08	135.4	133.0	149.6	154.8	127	124.5	158	160.5	1	0.6
32.9	62	1.40	146.9	144.2	163.1	168.9	138.5	135.5	171.5	174.5	1.5	1
34.3	66	1.48	156.9	154.2	173.1	178.9	148.5	145.5	181.5	184.5	1.5	1
38.3	99	2.30	170.5	167.3	189.5	196.4	160	155.5	200	204.5	2	1
39.6	105	2.42	180.5	177.3	199.5	206.3	170	165.5	210	214.5	2	1
41.0	111	2.55	190.5	187.3	209.5	216.3	180	175.5	220	224.5	2	1

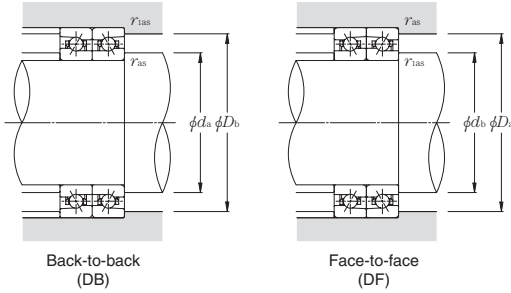
## ULTAGE High-speed angular contact ball bearings (ceramic ball type) 5S-2LA-HSE9U series

Contact angle  $20^\circ$   $d$  50~170mm



Part number	Boundary dimensions					Basic load ratings				Static axial load capacity		Limiting speed	
	mm					dynamic	static	dynamic	static	kN	kgf	min <sup>-1</sup>	
	d	D	B	r <sub>s</sub> min <sup>①</sup>	r <sub>is</sub> min <sup>①</sup>	C <sub>r</sub>	C <sub>or</sub>	C <sub>r</sub>	C <sub>or</sub>			grease lubrication	oil lubrication
5S-2LA-HSE910U	50	72	12	0.6	0.3	10.7	5.50	1 090	560	8.55	875	28 200	46 100
5S-2LA-HSE911U	55	80	13	1	0.6	13.3	6.85	1 360	700	10.7	1 090	25 500	41 700
5S-2LA-HSE912U	60	85	13	1	0.6	13.8	7.50	1 410	765	11.6	1 190	23700	38 800
5S-2LA-HSE913U	65	90	13	1	0.6	13.9	7.85	1 420	800	12.2	1 250	22 200	36 300
5S-2LA-HSE914U	70	100	16	1	0.6	20.4	11.2	2 080	1 140	17.4	1 780	20 200	33 100
5S-2LA-HSE915U	75	105	16	1	0.6	21.2	12.2	2 160	1 240	19.0	1 940	19 100	31 300
5S-2LA-HSE916U	80	110	16	1	0.6	21.4	12.7	2 190	1 290	19.8	2 020	18 100	29 600
5S-2LA-HSE917U	85	120	18	1.1	0.6	29.1	16.8	2 960	1 710	26.1	2 670	16 800	27 400
5S-2LA-HSE918U	90	125	18	1.1	0.6	30.0	18.1	3 100	1 850	28.3	2 890	16 000	26 200
5S-2LA-HSE919U	95	130	18	1.1	0.6	30.5	18.9	3 100	1 930	29.4	3 000	15 300	25 000
5S-2LA-HSE920U	100	140	20	1.1	0.6	35.5	22.1	3 600	2 260	34.0	3 500	14 300	23 400
5S-2LA-HSE921U	105	145	20	1.1	0.6	36.0	23.0	3 650	2 350	35.5	3 650	13 800	22 500
5S-2LA-HSE922U	110	150	20	1.1	0.6	36.5	23.9	3 700	2 430	37.0	3 800	13 200	21 600
5S-2LA-HSE924U	120	165	22	1.1	0.6	46.5	30.5	4 750	3 100	47.5	4 850	12 100	19 700
5S-2LA-HSE926U	130	180	24	1.5	1	57.5	38.0	5 850	3 850	58.5	6 000	11 100	18 100
5S-2LA-HSE928U	140	190	24	1.5	1	58.0	39.5	5 900	4 000	61.0	6 250	10 400	17 000
5S-2LA-HSE930U	150	210	28	2	1	77.5	52.0	7 900	5 350	81.0	8 300	9 600	15 600
5S-2LA-HSE932U	160	220	28	2	1	78.0	54.5	7 950	5 550	84.5	8 650	9 100	14 800
5S-2LA-HSE934U	170	230	28	2	1	79.0	56.5	8 050	5 750	88.0	9 000	8 600	14 100

① Minimum allowable value for corner radius dimension  $r$  or  $r_1$ .



**Dynamic equivalent radial load**  $P_r = X F_r + Y F_a$

e	Single row / Tandem				Back-to-back / Face-to-face			
	$F_a / F_r \leq e$		$F_a / F_r > e$		$F_a / F_r \leq e$		$F_a / F_r > e$	
	X	Y	X	Y	X	Y	X	Y
0.57	1	0	0.43	1	1	1.09	0.7	1.63

**Static equivalent radial load**  $P_{or} = X_0 F_r + Y_0 F_a$

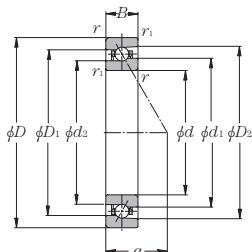
Single row / Tandem		Back-to-back / Face-to-face	
$X_0$	$Y_0$	$X_0$	$Y_0$
0.5	0.42	1	0.84

When  $P_{or} < F_r$  with single-row or tandem arrangement,  $P_{or} = F_r$ .

Load center mm	Internal free space cm <sup>3</sup> Single-row (approx.)	Mass kg Single-row (approx.)	Reference dimensions				Abutment and fillet dimensions					
			mm				mm					
			$d_1$	$d_2$	$D_1$	$D_2$	$d_a$ min	$d_b$ min	$D_a$ max	$D_b$ max	$r_{as}$ max	$r_{ias}$ max
17.2	6.0	0.12	57.6	56.6	64.4	66.8	54.5	52.5	67.5	69.5	0.6	0.3
18.9	7.7	0.17	63.6	62.4	71.4	74.1	60.5	59.5	74.5	75.5	1	0.6
19.8	8.3	0.18	68.6	67.4	76.4	79.1	65.5	64.5	79.5	80.5	1	0.6
20.7	8.9	0.19	73.6	72.4	81.4	84.0	70.5	69.5	84.5	85.5	1	0.6
23.6	14	0.31	80.1	78.6	89.8	93.2	75.5	74.5	94.5	95.5	1	0.6
24.5	15	0.33	85.1	83.6	94.8	98.2	80.5	79.5	99.5	100.5	1	0.6
25.4	16	0.34	90.1	88.6	99.8	103.2	85.5	84.5	104.5	105.5	1	0.6
27.8	22	0.48	96.8	94.9	108.2	112.3	92	89.5	113	115.5	1	0.6
28.7	23	0.51	101.8	99.9	113.2	117.3	97	94.5	118	120.5	1	0.6
29.6	24	0.53	106.8	104.9	118.2	122.3	102	99.5	123	125.5	1	0.6
32.0	32	0.74	113.8	111.7	126.2	130.6	107	104.5	133	135.5	1	0.6
32.9	33	0.77	118.8	116.7	131.2	135.6	112	109.5	138	140.5	1	0.6
33.8	35	0.80	123.8	121.7	136.2	140.6	117	114.5	143	145.5	1	0.6
37.1	47	1.08	135.4	133.0	149.6	154.7	127	124.5	158	160.5	1	0.6
40.4	62	1.40	146.9	144.2	163.1	168.9	138.5	135.5	171.5	174.5	1.5	1
42.2	66	1.48	156.9	154.2	173.1	178.8	148.5	145.5	181.5	184.5	1.5	1
47.0	99	2.30	170.5	167.3	189.5	196.3	160	155.5	200	204.5	2	1
48.8	105	2.42	180.5	177.3	199.5	206.3	170	165.5	210	214.5	2	1
50.6	111	2.55	190.5	187.3	209.5	216.3	180	175.5	220	224.5	2	1

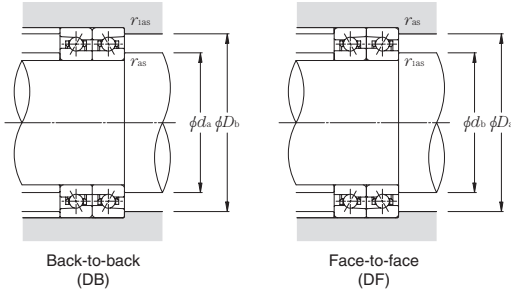
## ULTAGE High-speed angular contact ball bearings (ceramic ball type) 5S-2LA-HSE9U series

Contact angle 25°  $d$  50~170mm



Part number	Boundary dimensions					Basic load ratings				Static axial load capacity		Limiting speed	
	mm					dynamic	static	dynamic	static	kN	kgf	min <sup>-1</sup>	
	$d$	$D$	$B$	$r_{is}$ min <sup>①</sup>	$r_{is}$ min <sup>①</sup>	$C_r$	$C_{or}$	$C_r$	$C_{or}$			grease lubrication	oil lubrication
5S-2LA-HSE910UAD	50	72	12	0.6	0.3	10.3	5.30	1 050	545	9.75	995	24 300	41 000
5S-2LA-HSE911UAD	55	80	13	1	0.6	12.9	6.65	1 310	680	12.1	1 240	22 000	37 000
5S-2LA-HSE912UAD	60	85	13	1	0.6	13.3	7.3	1 360	740	13.3	1 360	20 500	34 500
5S-2LA-HSE913UAD	65	90	13	1	0.6	13.5	7.6	1 370	775	13.9	1 420	19 200	32 300
5S-2LA-HSE914UAD	70	100	16	1	0.6	19.7	10.8	2 010	1 100	19.9	2 030	17 500	29 400
5S-2LA-HSE915UAD	75	105	16	1	0.6	20.5	11.8	2 090	1 200	21.5	2 200	16 500	27 800
5S-2LA-HSE916UAD	80	110	16	1	0.6	20.7	12.3	2 110	1 250	22.5	2 300	15 600	26 300
5S-2LA-HSE917UAD	85	120	18	1.1	0.6	28.1	16.2	2 860	1 660	29.4	3 000	14 500	24 400
5S-2LA-HSE918UAD	90	125	18	1.1	0.6	29.2	17.6	2 980	1 790	31.5	3 250	13 800	23 300
5S-2LA-HSE919UAD	95	130	18	1.1	0.6	29.5	18.3	3 000	1 870	33.0	3 400	13 200	22 200
5S-2LA-HSE920UAD	100	140	20	1.1	0.6	34.5	21.4	3 500	2 190	39.0	4 000	12 400	20 800
5S-2LA-HSE921UAD	105	145	20	1.1	0.6	34.5	22.3	3 550	2 270	40.5	4 150	11 900	20 000
5S-2LA-HSE922UAD	110	150	20	1.1	0.6	35.0	23.1	3 600	2 360	42.0	4 300	11 400	19 200
5S-2LA-HSE924UAD	120	165	22	1.1	0.6	45.0	29.6	4 600	3 000	54.0	5 550	10 400	17 500
5S-2LA-HSE926UAD	130	180	24	1.5	1	55.5	36.5	5 700	3 750	67.0	6 850	9 600	16 100
5S-2LA-HSE928UAD	140	190	24	1.5	1	56.0	38.0	5 700	3 900	70.0	7 150	9 000	15 200
5S-2LA-HSE930UAD	150	210	28	2	1	75.0	50.5	7 650	5 150	92.5	9 450	8 200	13 900
5S-2LA-HSE932UAD	160	220	28	2	1	75.5	52.5	7 700	5 350	96.5	9 850	7 800	13 200
5S-2LA-HSE934UAD	170	230	28	2	1	76.0	54.5	7 750	5 600	100	10 200	7 400	12 500

① Minimum allowable value for corner radius dimension  $r$  or  $r_1$ .



**Dynamic equivalent radial load**  $P_r = X F_r + Y F_a$

e	Single row / Tandem				Back-to-back / Face-to-face			
	$F_a / F_r \leq e$		$F_a / F_r > e$		$F_a / F_r \leq e$		$F_a / F_r > e$	
	X	Y	X	Y	X	Y	X	Y
0.68	1	0	0.41	0.87	1	0.92	0.67	1.41

**Static equivalent radial load**  $P_{or} = X_0 F_r + Y_0 F_a$

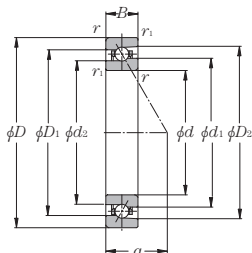
Single row / Tandem				Back-to-back / Face-to-face	
$X_0$	$Y_0$	$X_0$	$Y_0$		
0.5	0.38	1	0.76		

When  $P_{or} < F_r$  with single-row or tandem arrangement,  $P_{or} = F_r$ .

Load center mm	Internal free space cm <sup>3</sup> Single-row (approx.)	Mass kg Single-row (approx.)	Reference dimensions				Abutment and fillet dimensions					
			mm				mm					
			$d_1$	$d_2$	$D_1$	$D_2$	$d_a$ min	$d_b$ min	$D_a$ max	$D_b$ max	$r_{as}$ max	$r_{1as}$ max
20.3	6.0	0.12	57.6	56.6	64.4	66.7	54.5	52.5	67.5	69.5	0.6	0.3
22.4	7.7	0.17	63.6	62.4	71.4	74.1	60.5	59.5	74.5	75.5	1	0.6
23.5	8.3	0.18	68.6	67.4	76.4	79.0	65.5	64.5	79.5	80.5	1	0.6
24.7	8.9	0.19	73.6	72.4	81.4	84.0	70.5	69.5	84.5	85.5	1	0.6
28.0	14	0.31	80.1	78.6	89.8	93.2	75.5	74.5	94.5	95.5	1	0.6
29.1	15	0.33	85.1	83.6	94.8	98.2	80.5	79.5	99.5	100.5	1	0.6
30.3	16	0.34	90.1	88.6	99.8	103.2	85.5	84.5	104.5	105.5	1	0.6
33.1	22	0.48	96.8	94.9	108.2	112.3	92	89.5	113	115.5	1	0.6
34.2	23	0.51	101.8	99.9	113.2	117.3	97	94.5	118	120.5	1	0.6
35.4	24	0.53	106.8	104.9	118.2	122.3	102	99.5	123	125.5	1	0.6
38.2	32	0.74	113.8	111.7	126.2	130.6	107	104.5	133	135.5	1	0.6
39.3	33	0.77	118.8	116.7	131.2	135.6	112	109.5	138	140.5	1	0.6
40.5	35	0.80	123.8	121.7	136.2	140.6	117	114.5	143	145.5	1	0.6
44.4	47	1.08	135.4	133.0	149.6	154.7	127	124.5	158	160.5	1	0.6
48.4	62	1.40	146.9	144.2	163.1	168.8	138.5	135.5	171.5	174.5	1.5	1
50.7	66	1.48	156.9	154.2	173.1	178.8	148.5	145.5	181.5	184.5	1.5	1
56.3	99	2.30	170.5	167.3	189.5	196.3	160	155.5	200	204.5	2	1
58.6	105	2.42	180.5	177.3	199.5	206.3	170	165.5	210	214.5	2	1
60.9	111	2.55	190.5	187.3	209.5	216.3	180	175.5	220	224.5	2	1

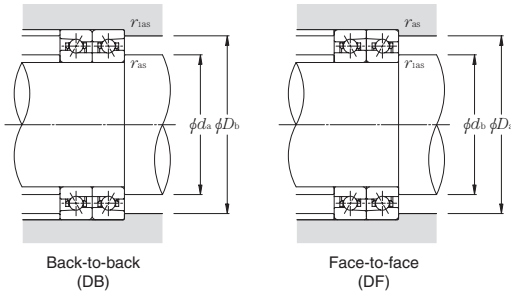
## ULTAGE High-speed angular contact ball bearings (ceramic ball type) 5S-2LA-HSE0 series

Contact angle 15°  $d$  50~170mm



Part number	Boundary dimensions						Basic load ratings				Static axial load capacity		Factor	Limiting speed	
	mm						dynamic		static		kN	kgf		min <sup>-1</sup>	
	d	D	B	r <sub>s</sub> min <sup>①</sup>	r <sub>1s</sub> min <sup>①</sup>	C <sub>r</sub>	C <sub>or</sub>	C <sub>r</sub>	C <sub>or</sub>	grease lubrication				oil lubrication	
5S-2LA-HSE010C	50	80	16	1	0.6	15.9	7.90	1 620	805	10.5	1 070	7.2	24 000	39 800	
5S-2LA-HSE011C	55	90	18	1.1	0.6	17.3	9.40	1 760	960	12.5	1 280	7.4	21 500	35 700	
5S-2LA-HSE012C	60	95	18	1.1	0.6	18.1	10.4	1 850	1 060	13.9	1 420	7.4	20 100	33 400	
5S-2LA-HSE013C	65	100	18	1.1	0.6	18.4	10.9	1 870	1 120	14.6	1 490	7.5	18 900	31 400	
5S-2LA-HSE014C	70	110	20	1.1	0.6	22.5	13.8	2 290	1 410	18.4	1 880	7.5	17 300	28 700	
5S-2LA-HSE015C	75	115	20	1.1	0.6	23.9	15.5	2 440	1 590	20.8	2 120	7.5	16 400	27 200	
5S-2LA-HSE016C	80	125	22	1.1	0.6	27.4	17.8	2 790	1 820	23.8	2 430	7.5	15 200	25 200	
5S-2LA-HSE017C	85	130	22	1.1	0.6	27.7	18.6	2 830	1 900	24.9	2 540	7.6	14 500	24 100	
5S-2LA-HSE018C	90	140	24	1.5	1	32.0	21.8	3 300	2 220	29.2	2 970	7.6	13 600	22 500	
5S-2LA-HSE019C	95	145	24	1.5	1	32.5	22.7	3 300	2 310	30.5	3 100	7.6	13 000	21 600	
5S-2LA-HSE020C	100	150	24	1.5	1	33.5	24.4	3 450	2 480	32.5	3 350	7.6	12 500	20 700	
5S-2LA-HSE021C	105	160	26	2	1	38.5	28.2	3 950	2 880	38.0	3 850	7.6	11 800	19 500	
5S-2LA-HSE022C	110	170	28	2	1	48.0	34.0	4 900	3 500	45.5	4 650	7.6	11 100	18 500	
5S-2LA-HSE024C	120	180	28	2	1	48.0	35.5	4 900	3 650	47.5	4 850	7.6	10 400	17 200	
5S-2LA-HSE026C	130	200	33	2	1	69.0	49.5	7 050	5 000	66.0	6 700	7.5	9 500	15 700	
5S-2LA-HSE028C	140	210	33	2	1	71.5	53.5	7 300	5 450	71.5	7 300	7.6	8 900	14 800	
5S-2LA-HSE030C	150	225	35	2.1	1.1	73.5	57.5	7 500	5 850	77.0	7 850	7.6	8 300	13 800	
5S-2LA-HSE032C	160	240	38	2.1	1.1	86.0	67.0	8 800	6 850	90.0	9 150	7.6	7 800	12 900	
5S-2LA-HSE034C	170	260	42	2.1	1.1	99.0	77.0	10 100	7 850	103	10 500	7.6	7 300	12 000	

① Minimum allowable value for corner radius dimension  $r$  or  $r_1$ .



### Dynamic equivalent radial load

$$P_r = X F_r + Y F_a$$

$i \cdot f_0 \cdot F_a / C_{Or}$	$e$	Single row / Tandem				Back-to-back / Face-to-face			
		$F_d / F_r \leq e$		$F_d / F_r > e$		$F_d / F_r \leq e$		$F_d / F_r > e$	
		X	Y	X	Y	X	Y	X	Y
0.178	0.35			1.57		1.76		2.56	
0.357	0.36			1.53		1.71		2.48	
0.714	0.38			1.46		1.64		2.38	
1.07	0.4			1.42		1.59		2.31	
1.43	0.41	1	0	1.38	1	1.55	0.72	2.25	
2.14	0.43			1.33		1.49		2.16	
3.57	0.44			1.25		1.4		2.03	
5.35	0.47			1.18		1.32		1.92	
7.14	0.49			1.13		1.26		1.83	

### Static equivalent radial load

$$P_{Or} = X_0 F_r + Y_0 F_a$$

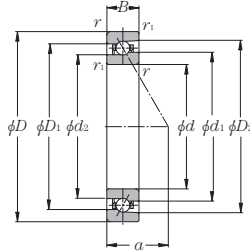
Single row / Tandem		Back-to-back / Face-to-face	
$X_0$	$Y_0$	$X_0$	$Y_0$
0.52	0.54	1.04	1.08

When  $P_{Or} < P_r$  with single-row or tandem arrangement,  $P_{Or} = P_r$ .

Load center mm	Internal free space cm <sup>3</sup>	Mass kg	Reference dimensions				Abutment and fillet dimensions					
			mm				mm					
			$d_1$	$d_2$	$D_1$	$D_2$	$d_a$ min	$d_b$ min	$D_a$ max	$D_b$ max	$r_{as}$ max	$r_{1as}$ max
16.8	12	0.23	60.1	58.6	69.9	73.3	55.5	54.5	74.5	75.5	1	0.6
18.8	16	0.37	67.6	66.2	77.4	80.8	62	59.5	83	85.5	1	0.6
19.5	17	0.40	72.6	71.2	82.4	85.8	67	64.5	88	90.5	1	0.6
20.1	18	0.42	77.6	76.2	87.4	90.8	72	69.5	93	95.5	1	0.6
22.2	24	0.60	84.8	83.0	95.2	99.1	77	74.5	103	105.5	1	0.6
22.8	25	0.64	89.8	88.0	100.2	104.1	82	79.5	108	110.5	1	0.6
24.8	34	0.86	96.8	94.9	108.2	112.5	87	84.5	118	120.5	1	0.6
25.5	35	0.90	101.8	99.9	113.2	117.5	92	89.5	123	125.5	1	0.6
27.5	45	1.18	108.8	106.7	121.2	125.8	98.5	95.5	131.5	134.5	1.5	1
28.2	47	1.23	113.8	111.7	126.2	130.8	103.5	100.5	136.5	139.5	1.5	1
28.9	49	1.28	118.8	116.7	131.2	135.8	108.5	105.5	141.5	144.5	1.5	1
30.9	61	1.63	125.8	123.6	139.2	144.1	115	110.5	150	154.5	2	1
32.9	77	1.99	132.4	129.8	147.6	153.3	120	115.5	160	164.5	2	1
34.2	82	2.14	142.4	139.8	157.6	163.3	130	125.5	170	174.5	2	1
38.8	130	3.18	155.5	152.3	174.5	181.6	140	135.5	190	194.5	2	1
40.1	129	3.41	165.5	162.4	184.5	191.5	150	145.5	200	204.5	2	1
42.8	163	4.17	178.0	174.8	197.0	204.1	162	157	213	218	2	1
46.0	206	5.09	189.5	186.0	210.5	218.2	172	167	228	233	2	1
50.0	272	6.90	203.6	199.8	226.4	234.9	182	177	248	253	2	1

## ULTAGE High-speed angular contact ball bearings (ceramic ball type) 5S-2LA-HSE0 series

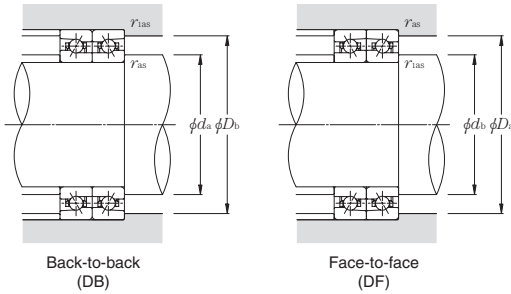
Contact angle  $20^\circ$   $d$  50~170mm



Part number	Boundary dimensions						Basic load ratings				Static axial load capacity		Limiting speed	
	mm						dynamic		static		kN	kgf	min <sup>-1</sup>	
	d	D	B	r <sub>s</sub> min <sup>①</sup>	r <sub>1s</sub> min <sup>①</sup>	C <sub>r</sub>	C <sub>or</sub>	C <sub>r</sub>	C <sub>or</sub>	grease lubrication			oil lubrication	
5S-2LA-HSE010	50	80	16	1	0.6	15.5	7.75	1 580	790	12.1	1 230	26 500	43 300	
5S-2LA-HSE011	55	90	18	1.1	0.6	16.8	9.20	1 720	935	14.4	1 460	23 700	38 800	
5S-2LA-HSE012	60	95	18	1.1	0.6	17.6	10.2	1 800	1 040	15.9	1 620	22 200	36 300	
5S-2LA-HSE013	65	100	18	1.1	0.6	17.9	10.7	1 830	1 090	16.7	1 710	20 800	34 100	
5S-2LA-HSE014	70	110	20	1.1	0.6	21.9	13.5	2 230	1 370	21.1	2 150	19 100	31 200	
5S-2LA-HSE015	75	115	20	1.1	0.6	23.3	15.2	2 380	1 550	23.8	2 420	18 100	29 600	
5S-2LA-HSE016	80	125	22	1.1	0.6	26.7	17.4	2 720	1 770	27.2	2 780	16 800	27 400	
5S-2LA-HSE017	85	130	22	1.1	0.6	27.0	18.1	2 760	1 850	28.4	2 900	16 000	26 200	
5S-2LA-HSE018	90	140	24	1.5	1	31.5	21.3	3 200	2 170	33.5	3 400	15 000	24 500	
5S-2LA-HSE019	95	145	24	1.5	1	31.5	22.1	3 250	2 260	34.5	3 550	14 300	23 400	
5S-2LA-HSE020	100	150	24	1.5	1	33.0	23.8	3 350	2 420	37.5	3 800	13 800	22 500	
5S-2LA-HSE021	105	160	26	2	1	37.5	27.5	3 850	2 810	43.0	4 400	13 000	21 200	
5S-2LA-HSE022	110	170	28	2	1	46.5	33.5	4 750	3 400	52.0	5 300	12 300	20 100	
5S-2LA-HSE024	120	180	28	2	1	47.0	35.0	4 800	3 550	54.5	5 550	11 500	18 700	
5S-2LA-HSE026	130	200	33	2	1	67.5	48.0	6 900	4 900	75.5	7 700	10 400	17 000	
5S-2LA-HSE028	140	210	33	2	1	70.0	52.0	7 100	5 300	81.5	8 300	9 800	16 100	
5S-2LA-HSE030	150	225	35	2.1	1.1	72.0	56.0	7 300	5 700	88.0	8 950	9 200	15 000	
5S-2LA-HSE032	160	240	38	2.1	1.1	84.0	65.5	8 550	6 700	103	10 500	8 600	14 100	
5S-2LA-HSE034	170	260	42	2.1	1.1	96.5	75.0	9 850	7 650	118	12 000	8 000	13 100	

① Minimum allowable value for corner radius dimension  $r$  or  $r_1$ .





**Dynamic equivalent radial load**  $P_r = X F_r + Y F_a$

e	Single row / Tandem				Back-to-back / Face-to-face			
	$F_a / F_r \leq e$		$F_a / F_r > e$		$F_a / F_r \leq e$		$F_a / F_r > e$	
	X	Y	X	Y	X	Y	X	Y
0.57	1	0	0.43	1	1	1.09	0.7	1.63

**Static equivalent radial load**  $P_{or} = X_0 F_r + Y_0 F_a$

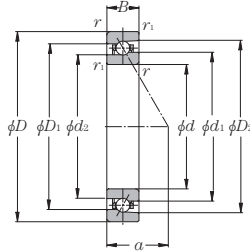
Single row / Tandem		Back-to-back / Face-to-face	
$X_0$	$Y_0$	$X_0$	$Y_0$
0.5	0.42	1	0.84

When  $P_{or} < F_r$  with single-row or tandem arrangement,  $P_{or} = F_r$ .

Load center mm	Internal free space cm <sup>3</sup>	Mass kg	Reference dimensions				Abutment and fillet dimensions					
			mm				mm					
			$d_1$	$d_2$	$D_1$	$D_2$	$d_a$ min	$d_b$ min	$D_a$ max	$D_b$ max	$r_{as}$ max	$r_{1as}$ max
19.9	12	0.23	60.1	58.6	69.9	73.2	55.5	54.5	74.5	75.5	1	0.6
22.3	16	0.37	67.6	66.2	77.4	80.8	62	59.5	83	85.5	1	0.6
23.2	17	0.40	72.6	71.2	82.4	85.8	67	64.5	88	90.5	1	0.6
24.1	18	0.42	77.6	76.2	87.4	90.8	72	69.5	93	95.5	1	0.6
26.5	24	0.60	84.8	83.0	95.2	99.1	77	74.5	103	105.5	1	0.6
27.4	25	0.64	89.8	88.0	100.2	104.1	82	79.5	108	110.5	1	0.6
29.8	34	0.86	96.8	94.9	108.2	112.5	87	84.5	118	120.5	1	0.6
30.7	35	0.90	101.8	99.9	113.2	117.4	92	89.5	123	125.5	1	0.6
33.1	45	1.18	108.8	106.7	121.2	125.8	98.5	95.5	131.5	134.5	1.5	1
34.0	47	1.23	113.8	111.7	126.2	130.8	103.5	100.5	136.5	139.5	1.5	1
34.9	49	1.28	118.8	116.7	131.2	135.8	108.5	105.5	141.5	144.5	1.5	1
37.3	61	1.63	125.8	123.6	139.2	144.1	115	110.5	150	154.5	2	1
39.7	77	1.99	132.4	129.8	147.6	153.2	120	115.5	160	164.5	2	1
41.5	82	2.14	142.4	139.8	157.6	163.2	130	125.5	170	174.5	2	1
46.8	130	3.18	155.5	152.3	174.5	181.5	140	135.5	190	194.5	2	1
48.6	129	3.41	165.5	162.4	184.5	191.5	150	145.5	200	204.5	2	1
51.9	163	4.17	178.0	174.8	197.0	204.0	162	157	213	218	2	1
55.7	206	5.09	189.5	186.0	210.5	218.2	172	167	228	233	2	1
60.4	272	6.90	203.6	199.8	226.4	234.9	182	177	248	253	2	1

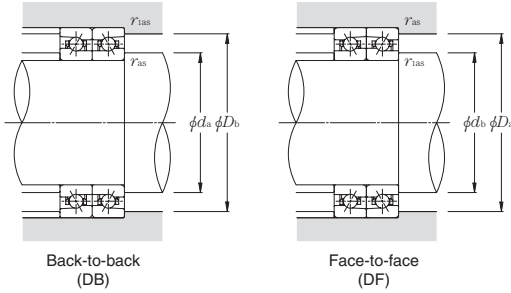
## ULTAGE High-speed angular contact ball bearings (ceramic ball type) 5S-2LA-HSE0 series

Contact angle 25°  $d$  50~170mm



Part number	Boundary dimensions						Basic load ratings				Static axial load capacity		Limiting speed	
	mm						dynamic		static		kN	kgf	min <sup>-1</sup>	
	d	D	B	r <sub>s</sub> min <sup>①</sup>	r <sub>is</sub> min <sup>①</sup>	C <sub>r</sub>	C <sub>or</sub>	C <sub>r</sub>	C <sub>or</sub>	grease lubrication			oil lubrication	
5S-2LA-HSE010AD	50	80	16	1	0.6	15.0	7.50	1 530	765	13.8	1 400	22 800	38 500	
5S-2LA-HSE011AD	55	90	18	1.1	0.6	16.3	8.90	1 660	910	16.4	1 670	20 500	34 500	
5S-2LA-HSE012AD	60	95	18	1.1	0.6	17.1	9.85	1 740	1 000	18.1	1 850	19 200	32 300	
5S-2LA-HSE013AD	65	100	18	1.1	0.6	17.3	10.4	1 770	1 060	19.0	1 940	18 000	30 300	
5S-2LA-HSE014AD	70	110	20	1.1	0.6	21.2	13.0	2 160	1 330	24.0	2 440	16 500	27 800	
5S-2LA-HSE015AD	75	115	20	1.1	0.6	22.5	14.7	2 300	1 500	27.0	2 760	15 600	26 300	
5S-2LA-HSE016AD	80	125	22	1.1	0.6	25.8	16.9	2 630	1 720	31.0	3 150	14 500	24 400	
5S-2LA-HSE017AD	85	130	22	1.1	0.6	26.1	17.6	2 660	1 790	32.5	3 300	13 800	23 300	
5S-2LA-HSE018AD	90	140	24	1.5	1	30.5	20.6	3 100	2 100	38.0	3 850	12 900	21 700	
5S-2LA-HSE019AD	95	145	24	1.5	1	30.5	21.4	3 150	2 190	39.5	4 000	12 400	20 800	
5S-2LA-HSE020AD	100	150	24	1.5	1	31.5	23.0	3 250	2 350	42.5	4 300	11 900	20 000	
5S-2LA-HSE021AD	105	160	26	2	1	36.5	26.7	3 700	2 720	49.0	5 000	11 200	18 900	
5S-2LA-HSE022AD	110	170	28	2	1	45.0	32.5	4 600	3 300	59.5	6 050	10 600	17 900	
5S-2LA-HSE024AD	120	180	28	2	1	45.5	33.5	4 650	3 450	62.0	6 300	9 900	16 700	
5S-2LA-HSE026AD	130	200	33	2	1	65.0	46.5	6 650	4 750	85.5	8 750	9 000	15 200	
5S-2LA-HSE028AD	140	210	33	2	1	67.5	50.5	6 900	5 150	92.5	9 450	8 500	14 300	
5S-2LA-HSE030AD	150	225	35	2.1	1.1	69.5	54.5	7 050	5 550	100	10 200	7 900	13 300	
5S-2LA-HSE032AD	160	240	38	2.1	1.1	81.0	63.5	8 300	6 450	117	11 900	7 400	12 500	
5S-2LA-HSE034AD	170	260	42	2.1	1.1	93.0	73.0	9 500	7 450	134	13 700	6 900	11 600	

① Minimum allowable value for corner radius dimension  $r$  or  $r_1$ .



**Dynamic equivalent radial load**  $P_r = X F_r + Y F_a$

e	Single row / Tandem				Back-to-back / Face-to-face			
	$F_a / F_r \leq e$		$F_a / F_r > e$		$F_a / F_r \leq e$		$F_a / F_r > e$	
	X	Y	X	Y	X	Y	X	Y
0.68	1	0	0.41	0.87	1	0.92	0.67	1.41

**Static equivalent radial load**  $P_{or} = X_0 F_r + Y_0 F_a$

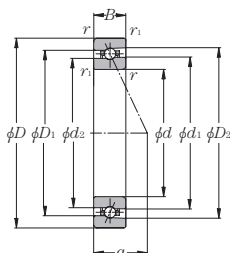
Single row / Tandem		Back-to-back / Face-to-face	
$X_0$	$Y_0$	$X_0$	$Y_0$
0.5	0.38	1	0.76

When  $P_{or} < F_r$  with single-row or tandem arrangement,  $P_{or} = F_r$ .

Load center mm	Internal free space cm <sup>3</sup> Single-row (approx.)	Mass kg Single-row (approx.)	Reference dimensions mm				Abutment and fillet dimensions mm					
			$d_1$	$d_2$	$D_1$	$D_2$	$d_a$ min	$d_b$ min	$D_a$ max	$D_b$ max	$r_{as}$ max	$r_{1as}$ max
23.3	12	0.23	60.1	58.6	69.9	73.2	55.5	54.5	74.5	75.5	1	0.6
26.1	16	0.37	67.6	66.2	77.4	80.8	62	59.5	83	85.5	1	0.6
27.2	17	0.40	72.6	71.2	82.4	85.8	67	64.5	88	90.5	1	0.6
28.4	18	0.40	77.6	76.2	87.4	90.8	72	69.5	93	95.5	1	0.6
31.1	24	0.60	84.8	83.0	95.2	99.1	77	74.5	103	105.5	1	0.6
32.3	25	0.64	89.8	88.0	100.2	104.1	82	79.5	108	110.5	1	0.6
35.1	34	0.86	96.8	94.9	108.2	112.5	87	84.5	118	120.5	1	0.6
36.2	35	0.90	101.8	99.9	113.2	117.4	92	89.5	123	125.5	1	0.6
39.0	45	1.18	108.8	106.7	121.2	125.8	98.5	95.5	131.5	134.5	1.5	1
40.2	47	1.23	113.8	111.7	126.2	130.8	103.5	100.5	136.5	139.5	1.5	1
41.3	49	1.28	118.8	116.7	131.2	135.8	108.5	105.5	141.5	144.5	1.5	1
44.1	61	1.63	125.8	123.6	139.2	144.1	115	110.5	150	154.5	2	1
46.9	77	1.99	132.4	129.8	147.6	153.2	120	115.5	160	164.5	2	1
49.2	82	2.14	142.4	139.8	157.6	163.2	130	125.5	170	174.5	2	1
55.3	130	3.18	155.5	152.3	174.5	181.5	140	135.5	190	194.5	2	1
57.6	129	3.41	165.5	162.4	184.5	191.5	150	145.5	200	204.5	2	1
61.5	163	4.17	178.0	174.8	197.0	204.0	162	157	213	218	2	1
66.0	206	5.09	189.5	186.0	210.5	218.2	172	167	228	233	2	1
71.5	272	6.90	203.6	199.8	226.4	234.9	182	177	248	253	2	1

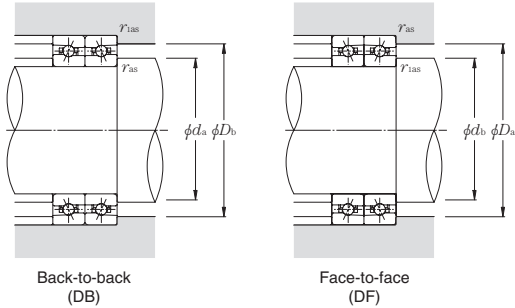
## ULTAGE Super high-speed angular contact ball bearings 5S-2LA-HSF0 series

Contact angle 25°  $d$  50~100mm



Part number	Boundary dimensions						Basic load ratings				Static axial load capacity		Limiting speed min <sup>-1</sup> oil lubrication
	mm						dynamic	static	dynamic	static	kN	kgf	
	$d$	$D$	$B$	$r_{3 \text{ min}}^{\text{①}}$	$r_{18 \text{ min}}^{\text{①}}$		$C_r$	$C_{or}$	$C_r$	$C_{or}$			
5S-2LA-HSF010AD	50	80	16	1	0.6	10.1	6.20	1 030	635	11.4	1 170	50 000	
5S-2LA-HSF011AD	55	90	18	1.1	0.6	12.6	7.80	1 280	800	14.4	1 470	44 800	
5S-2LA-HSF012AD	60	95	18	1.1	0.6	12.9	8.45	1 320	860	15.5	1 580	41 900	
5S-2LA-HSF013AD	65	100	18	1.1	0.6	13.3	9.05	1 360	925	16.7	1 700	39 400	
5S-2LA-HSF014AD	70	110	20	1.1	0.6	16.2	11.1	1 650	1 130	20.4	2 080	36 100	
5S-2LA-HSF015AD	75	115	20	1.1	0.6	16.7	11.9	1 700	1 210	21.8	2 220	34 200	
5S-2LA-HSF016AD	80	125	22	1.1	0.6	19.9	14.2	2 030	1 440	26.0	2 660	31 700	
5S-2LA-HSF017AD	85	130	22	1.1	0.6	20.1	14.7	2 050	1 500	27.0	2 750	30 200	
5S-2LA-HSF018AD	90	140	24	1.5	1	24.5	18.2	2 500	1 860	33.5	3 400	28 300	
5S-2LA-HSF019AD	95	145	24	1.5	1	24.7	18.8	2 520	1 920	34.5	3 550	27 100	
5S-2LA-HSF020AD	100	150	24	1.5	1	25.3	20.0	2 580	2 040	37.0	3 750	26 000	

① Minimum allowable value for corner radius dimension  $r$  or  $r_1$ .



**Dynamic equivalent radial load**  $P_r = X F_r + Y F_a$

e	Single row / Tandem				Back-to-back / Face-to-face			
	$F_a / F_r \leq e$		$F_a / F_r > e$		$F_a / F_r \leq e$		$F_a / F_r > e$	
	X	Y	X	Y	X	Y	X	Y
0.68	1	0	0.41	0.87	1	0.92	0.67	1.41

**Static equivalent radial load**  $P_{or} = X_0 F_r + Y_0 F_a$

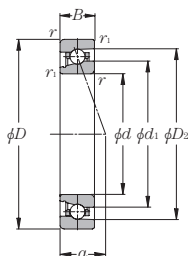
Single row / Tandem		Back-to-back / Face-to-face	
$X_0$	$Y_0$	$X_0$	$Y_0$
0.5	0.38	1	0.76

When  $P_{or} < F_r$  with single-row or tandem arrangement,  $P_{or} = F_r$ .

Load center mm	Internal free space cm <sup>3</sup>	Mass kg	Reference dimensions				Abutment and fillet dimensions												
			mm				mm												
			$d_1$	$d_2$	$D_1$	$D_2$	$d_a$ min	$d_b$ min	$D_a$ max	$D_b$ max	$r_{as}$ max	$r_{1as}$ max							
a	Single-row (approx.)	Single-row (approx.)																	
23.3	10	0.29	61.6	60.6	68.4	70.9	55.5	54.5	74.5	75.5	1	0.6							
26.0	14	0.42	68.6	67.4	76.4	79.2	62	59.5	83	85.5	1	0.6							
27.2	15	0.45	73.6	72.4	81.4	84.2	67	64.5	88	90.5	1	0.6							
28.3	16	0.48	78.6	77.4	86.4	89.2	72	69.5	93	95.5	1	0.6							
31.1	22	0.67	85.6	84.3	94.4	97.5	77	74.5	103	105.5	1	0.6							
32.3	24	0.71	90.6	89.3	99.4	102.5	82	79.5	108	110.5	1	0.6							
35.0	31	0.95	97.6	96.2	107.4	110.8	87	84.5	118	120.5	1	0.6							
36.2	33	1.00	102.6	101.2	112.4	115.8	92	89.5	123	125.5	1	0.6							
39.0	41	1.31	109.8	108.0	120.2	124.2	98.5	95.5	131.5	134.5	1.5	1							
40.1	43	1.36	114.8	113.0	125.2	129.2	103.5	100.5	136.5	139.5	1.5	1							
41.3	45	1.42	119.8	118.0	130.2	134.2	108.5	105.5	141.5	144.5	1.5	1							

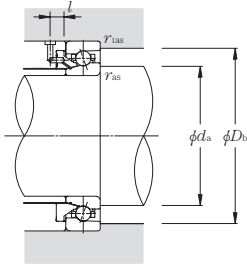
## ULTAGE Eco-friendly angular contact ball bearings (ceramic ball type) 5S-2LA-HSL9U series

Contact angle 20°  $d$  50~130mm



Part number	Boundary dimensions mm						Basic load ratings				Static axial load capacity		Limiting speed min <sup>-1</sup> oil lubrication
	$d$	$D$	$B$	$r_{3 \text{ min}}$ <sup>①</sup>	$r_{18 \text{ min}}$ <sup>①</sup>	$C_t$	$C_{or}$	$C_t$	$C_{or}$	kN	kgf		
5S-2LA-HSL910U	50	72	12	0.6	0.3	10.7	5.50	1 090	560	8.55	875	46 100	
5S-2LA-HSL911U	55	80	13	1	0.6	13.3	6.85	1 360	700	10.6	1 090	41 700	
5S-2LA-HSL912U	60	85	13	1	0.6	13.8	7.50	1 410	765	11.6	1 190	38 800	
5S-2LA-HSL913U	65	90	13	1	0.6	13.9	7.85	1 420	800	12.2	1 250	36 300	
5S-2LA-HSL914U	70	100	16	1	0.6	20.4	11.2	2 080	1 140	17.4	1 780	33 100	
5S-2LA-HSL915U	75	105	16	1	0.6	21.2	12.2	2 160	1 240	19.0	1 940	31 300	
5S-2LA-HSL916U	80	110	16	1	0.6	21.4	12.7	2 190	1 290	19.8	2 020	29 600	
5S-2LA-HSL917U	85	120	18	1.1	0.6	29.1	16.8	2 960	1 710	26.1	2 670	27 400	
5S-2LA-HSL918U	90	125	18	1.1	0.6	30.0	18.1	3 100	1 850	28.3	2 890	26 200	
5S-2LA-HSL919U	95	130	18	1.1	0.6	30.5	18.9	3 100	1 930	29.4	3 000	25 000	
5S-2LA-HSL920U	100	140	20	1.1	0.6	35.5	22.1	3 600	2 260	34.0	3 500	23 400	
5S-2LA-HSL921U	105	145	20	1.1	0.6	36.0	23.0	3 650	2 350	35.5	3 650	22 500	
5S-2LA-HSL922U	110	150	20	1.1	0.6	36.5	23.9	3 700	2 430	37.0	3 800	21 600	
5S-2LA-HSL924U	120	165	22	1.1	0.6	46.5	30.5	4 750	3 100	47.5	4 850	19 700	
5S-2LA-HSL926U	130	180	24	1.5	1	57.5	38.0	5 850	3 850	58.5	6 000	18 100	

- ① Minimum allowable value for corner radius dimension  $r$  or  $r_1$ .  
 ② For the details of spacer dimensions, please contact NTN Engineering.



**Dynamic equivalent radial load**  $P_r = X F_r + Y F_a$

$e$	Single row / Tandem				Back-to-back / Face-to-face			
	$F_a / F_r \leq e$		$F_a / F_r > e$		$F_a / F_r \leq e$		$F_a / F_r > e$	
	$X$	$Y$	$X$	$Y$	$X$	$Y$	$X$	$Y$
0.57	1	0	0.43	1	1	1.09	0.7	1.63

**Static equivalent radial load**  $P_{or} = X_0 F_r + Y_0 F_a$

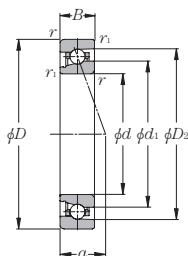
Single row / Tandem		Back-to-back / Face-to-face	
$X_0$	$Y_0$	$X_0$	$Y_0$
0.5	0.42	1	0.84

When  $P_{or} < F_r$  with single-row or tandem arrangement,  $P_{or} = F_r$ .

Load center mm	Mass kg Single-row (approx.)	Reference dimensions mm		Abutment and fillet dimensions mm				Part number
		$d_1$	$D_2$	$d_a$ min	$D_0$ max	$r_{1as}$ max	$t$ min	
17.2	0.11	57.6	66.8	54.5	69.5	0.3	8.5	5S-2LA-HSL910U
18.9	0.16	63.6	74.1	60.5	75.5	0.6	8.5	5S-2LA-HSL911U
19.8	0.17	68.6	79.1	65.5	80.5	0.6	8.5	5S-2LA-HSL912U
20.7	0.17	73.6	84.0	70.5	85.5	0.6	8.5	5S-2LA-HSL913U
23.6	0.29	80.1	93.2	75.5	95.5	0.6	8.5	5S-2LA-HSL914U
24.5	0.31	85.1	98.2	80.5	100.5	0.6	9	5S-2LA-HSL915U
25.4	0.32	90.1	103.2	85.5	105.5	0.6	9	5S-2LA-HSL916U
27.8	0.45	96.8	112.3	92	115.5	0.6	9	5S-2LA-HSL917U
28.7	0.48	101.8	117.3	97	120.5	0.6	9	5S-2LA-HSL918U
29.6	0.50	106.8	122.3	102	125.5	0.6	9	5S-2LA-HSL919U
32.0	0.69	113.8	130.6	107	135.5	0.6	9	5S-2LA-HSL920U
32.9	0.72	118.8	135.6	112	140.5	0.6	9	5S-2LA-HSL921U
33.8	0.75	123.8	140.6	117	145.5	0.6	9	5S-2LA-HSL922U
37.1	1.01	135.4	154.7	127	160.5	0.6	9	5S-2LA-HSL924U
40.4	1.32	146.9	168.9	138.5	174.5	1	9	5S-2LA-HSL926U

## ULTAGE Eco-friendly angular contact ball bearings (ceramic ball type) 5S-2LA-HSL9U series

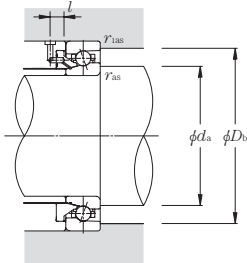
Contact angle 25°  $d$  50~130mm



Part number	Boundary dimensions mm					Basic load ratings				Static axial load capacity		Limiting speed min <sup>-1</sup> oil lubrication
	$d$	$D$	$B$	$r_{3 \text{ min}}$ <sup>①</sup>	$r_{18 \text{ min}}$ <sup>①</sup>	dynamic kN	static $C_{or}$	dynamic kgf	static $C_{or}$	kN	kgf	
5S-2LA-HSL910UAD	50	72	12	0.6	0.3	10.3	5.30	1 050	545	9.75	995	41 000
5S-2LA-HSL911UAD	55	80	13	1	0.6	12.9	6.65	1 310	680	12.1	1 240	37 000
5S-2LA-HSL912UAD	60	85	13	1	0.6	13.3	7.3	1 360	740	13.3	1 360	34 500
5S-2LA-HSL913UAD	65	90	13	1	0.6	13.5	7.6	1 370	775	13.9	1 420	32 300
5S-2LA-HSL914UAD	70	100	16	1	0.6	19.7	10.8	2 010	1 100	19.9	2 030	29 400
5S-2LA-HSL915UAD	75	105	16	1	0.6	20.5	11.8	2 090	1 200	21.5	2 200	27 800
5S-2LA-HSL916UAD	80	110	16	1	0.6	20.7	12.3	2 110	1 250	22.5	2 300	26 300
5S-2LA-HSL917UAD	85	120	18	1.1	0.6	28.1	16.2	2 860	1 660	29.4	3 000	24 400
5S-2LA-HSL918UAD	90	125	18	1.1	0.6	29.2	17.6	2 980	1 790	31.5	3 250	23 300
5S-2LA-HSL919UAD	95	130	18	1.1	0.6	29.5	18.3	3 000	1 870	33.0	3 400	22 200
5S-2LA-HSL920UAD	100	140	20	1.1	0.6	34.5	21.4	3 500	2 190	39.0	4 000	20 800
5S-2LA-HSL921UAD	105	145	20	1.1	0.6	34.5	22.3	3 550	2 270	40.5	4 150	20 000
5S-2LA-HSL922UAD	110	150	20	1.1	0.6	35.0	23.1	3 600	2 360	42.0	4 300	19 200
5S-2LA-HSL924UAD	120	165	22	1.1	0.6	45.0	29.6	4 600	3 000	54.0	5 550	17 500
5S-2LA-HSL926UAD	130	180	24	1.5	1	55.5	36.5	5 700	3 750	67.0	6 850	16 100

- ① Minimum allowable value for corner radius dimension  $r$  or  $r_1$ .
- ② For the details of spacer dimensions, please contact NTN Engineering.





**Dynamic equivalent radial load**  $P_r = XF_r + YF_a$

e	Single row / Tandem				Back-to-back / Face-to-face			
	$F_a/F_r \leq e$		$F_a/F_r > e$		$F_a/F_r \leq e$		$F_a/F_r > e$	
	X	Y	X	Y	X	Y	X	Y
0.68	1	0	0.41	0.87	1	0.92	0.67	1.41

**Static equivalent radial load**  $P_{or} = X_0 F_r + Y_0 F_a$

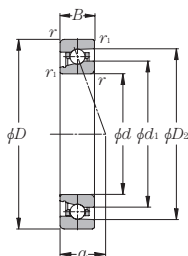
Single row / Tandem		Back-to-back / Face-to-face	
$X_0$	$Y_0$	$X_0$	$Y_0$
0.5	0.38	1	0.76

When  $P_{or} < F_r$  with single-row or tandem arrangement,  $P_{or} = F_r$ .

Load center mm	Mass kg Single-row (approx.)	Reference dimensions mm		Abutment and fillet dimensions mm				Part number
		$d_1$	$D_2$	$d_a$ min	$D_0$ max	$r_{1as}$ max	$l$ min	
20.3	0.11	57.6	66.7	54.5	69.5	0.3	8.5	5S-2LA-HSL910UAD
22.4	0.16	63.6	74.1	60.5	75.5	0.6	8.5	5S-2LA-HSL911UAD
23.5	0.17	68.6	79.0	65.5	80.5	0.6	8.5	5S-2LA-HSL912UAD
24.7	0.17	73.6	84.0	70.5	85.5	0.6	8.5	5S-2LA-HSL913UAD
28.0	0.29	80.1	93.2	75.5	95.5	0.6	8.5	5S-2LA-HSL914UAD
29.1	0.31	85.1	98.2	80.5	100.5	0.6	9	5S-2LA-HSL915UAD
30.3	0.32	90.1	103.2	85.5	105.5	0.6	9	5S-2LA-HSL916UAD
33.1	0.45	96.8	112.3	92	115.5	0.6	9	5S-2LA-HSL917UAD
34.2	0.48	101.8	117.3	97	120.5	0.6	9	5S-2LA-HSL918UAD
35.4	0.50	106.8	122.3	102	125.5	0.6	9	5S-2LA-HSL919UAD
38.2	0.69	113.8	130.6	107	135.5	0.6	9	5S-2LA-HSL920UAD
39.3	0.72	118.8	135.6	112	140.5	0.6	9	5S-2LA-HSL921UAD
40.5	0.75	123.8	140.6	117	145.5	0.6	9	5S-2LA-HSL922UAD
44.4	1.01	135.4	154.7	127	160.5	0.6	9	5S-2LA-HSL924UAD
48.4	1.32	146.9	168.8	138.5	174.5	1	9	5S-2LA-HSL926UAD

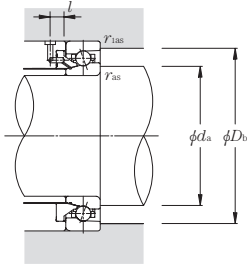
## ULTAGE Eco-friendly angular contact ball bearings (ceramic ball type) 5S-2LA-HSL0 series

Contact angle 20°  $d$  50~130mm



Part number	Boundary dimensions						Basic load ratings				Static axial load capacity		Limiting speed min <sup>-1</sup> oil lubrication
	mm						dynamic kN		dynamic kgf		kN	kgf	
	$d$	$D$	$B$	$r_{3 \text{ min}}$ <sup>①</sup>	$r_{18 \text{ min}}$ <sup>①</sup>	$C_t$	$C_{or}$	$C_t$	$C_{or}$				
5S-2LA-HSL010	50	80	16	1	0.6	15.5	7.75	1 580	790	12.1	1 230	43 300	
5S-2LA-HSL011	55	90	18	1.1	0.6	16.8	9.20	1 720	935	14.4	1 460	38 800	
5S-2LA-HSL012	60	95	18	1.1	0.6	17.6	10.2	1 800	1 040	15.9	1 620	36 300	
5S-2LA-HSL013	65	100	18	1.1	0.6	17.9	10.7	1 830	1 090	16.7	1 710	34 100	
5S-2LA-HSL014	70	110	20	1.1	0.6	21.9	13.5	2 230	1 370	21.1	2 150	31 200	
5S-2LA-HSL015	75	115	20	1.1	0.6	23.3	15.2	2 380	1 550	23.8	2 420	29 600	
5S-2LA-HSL016	80	125	22	1.1	0.6	26.7	17.4	2 720	1 770	27.2	2 780	27 400	
5S-2LA-HSL017	85	130	22	1.1	0.6	27.0	18.1	2 760	1 850	28.4	2 900	26 200	
5S-2LA-HSL018	90	140	24	1.5	1	31.5	21.3	3 200	2 170	33.5	3 400	24 500	
5S-2LA-HSL019	95	145	24	1.5	1	31.5	22.1	3 250	2 260	34.5	3 550	23 400	
5S-2LA-HSL020	100	150	24	1.5	1	33.0	23.8	3 350	2 420	37.5	3 800	22 500	
5S-2LA-HSL021	105	160	26	2	1	37.5	27.5	3 850	2 810	43.0	4 400	21 200	
5S-2LA-HSL022	110	170	28	2	1	46.5	33.5	4 750	3 400	52.0	5 300	20 100	
5S-2LA-HSL024	120	180	28	2	1	47.0	35.0	4 800	3 550	54.5	5 550	18 700	
5S-2LA-HSL026	130	200	33	2	1	67.5	48.0	6 900	4 900	75.5	7 700	17 000	

- ① Minimum allowable value for corner radius dimension  $r$  or  $r_1$ .
- ② For the details of spacer dimensions, please contact NTN Engineering.



**Dynamic equivalent radial load**  $P_r = X F_r + Y F_a$

e	Single row / Tandem				Back-to-back / Face-to-face			
	$F_a / F_r \leq e$		$F_a / F_r > e$		$F_a / F_r \leq e$		$F_a / F_r > e$	
	X	Y	X	Y	X	Y	X	Y
0.57	1	0	0.43	1	1	1.09	0.7	1.63

**Static equivalent radial load**  $P_{or} = X_0 F_r + Y_0 F_a$

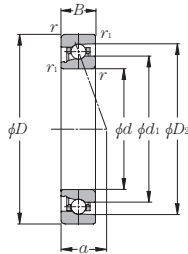
Single row / Tandem		Back-to-back / Face-to-face	
$X_0$	$Y_0$	$X_0$	$Y_0$
0.5	0.42	1	0.84

When  $P_{or} < F_r$  with single-row or tandem arrangement,  $P_{or} = F_r$ .

Load center mm	Mass kg Single-row (approx.)	Reference dimensions mm		Abutment and fillet dimensions mm				Part number
		$d_1$	$D_2$	$d_a$ min	$D_b$ max	$r_{1as}$ max	$l$ min	
19.9	0.22	60.1	73.2	55.5	75.5	0.6	8.5	5S-2LA-HSL010
22.3	0.35	67.6	80.8	62	85.5	0.6	8.5	5S-2LA-HSL011
23.2	0.38	72.6	85.8	67	90.5	0.6	8.5	5S-2LA-HSL012
24.1	0.40	77.6	90.8	72	95.5	0.6	9	5S-2LA-HSL013
26.5	0.57	84.8	99.1	77	105.5	0.6	9	5S-2LA-HSL014
27.4	0.60	89.8	104.1	82	110.5	0.6	9	5S-2LA-HSL015
29.8	0.82	96.8	112.5	87	120.5	0.6	9	5S-2LA-HSL016
30.7	0.85	101.8	117.4	92	125.5	0.6	9	5S-2LA-HSL017
33.1	1.12	108.8	125.8	98.5	134.5	1	9	5S-2LA-HSL018
34.0	1.17	113.8	130.8	103.5	139.5	1	9	5S-2LA-HSL019
34.9	1.22	118.8	135.8	108.5	144.5	1	9	5S-2LA-HSL020
37.3	1.55	125.8	144.1	115	154.5	1	9	5S-2LA-HSL021
39.7	1.89	132.4	153.2	120	164.5	1	9	5S-2LA-HSL022
41.5	2.03	142.4	163.2	130	174.5	1	9	5S-2LA-HSL024
46.8	2.98	155.5	181.5	140	194.5	1	9	5S-2LA-HSL026

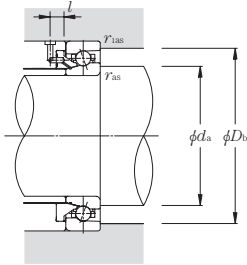
## ULTAGE Eco-friendly angular contact ball bearings (ceramic ball type) 5S-2LA-HSL0 series

Contact angle 25°  $d$  50~130mm



Part number	Boundary dimensions						Basic load ratings				Static axial load capacity		Limiting speed min <sup>-1</sup> oil lubrication
	mm						dynamic	static	dynamic	static	kN	kgf	
	$d$	$D$	$B$	$r_{3 \text{ min}}$ <sup>①</sup>	$r_{18 \text{ min}}$ <sup>①</sup>	$C_r$	$C_{or}$	$C_r$	$C_{or}$				
5S-2LA-HSL010AD	50	80	16	1	0.6	15.0	7.50	1 530	765	13.8	1 400	38 500	
5S-2LA-HSL011AD	55	90	18	1.1	0.6	16.3	8.90	1 660	910	16.4	1 670	34 500	
5S-2LA-HSL012AD	60	95	18	1.1	0.6	17.1	9.85	1 740	1 000	18.1	1 850	32 300	
5S-2LA-HSL013AD	65	100	18	1.1	0.6	17.3	10.4	1 770	1 060	19.0	1 940	30 300	
5S-2LA-HSL014AD	70	110	20	1.1	0.6	21.2	13.0	2 160	1 330	24.0	2 440	27 800	
5S-2LA-HSL015AD	75	115	20	1.1	0.6	22.5	14.7	2 300	1 500	27.0	2 760	26 300	
5S-2LA-HSL016AD	80	125	22	1.1	0.6	25.8	16.9	2 630	1 720	31.0	3 150	24 400	
5S-2LA-HSL017AD	85	130	22	1.1	0.6	26.1	17.6	2 660	1 790	32.5	3 300	23 300	
5S-2LA-HSL018AD	90	140	24	1.5	1	30.5	20.6	3 100	2 100	38.0	3 850	21 700	
5S-2LA-HSL019AD	95	145	24	1.5	1	30.5	21.4	3 150	2 190	39.5	4 000	20 800	
5S-2LA-HSL020AD	100	150	24	1.5	1	31.5	23.0	3 250	2 350	42.5	4 300	20 000	
5S-2LA-HSL021AD	105	160	26	2	1	36.5	26.7	3 700	2 720	49.0	5 000	18 900	
5S-2LA-HSL022AD	110	170	28	2	1	45.0	32.5	4 600	3 300	59.5	6 050	17 700	
5S-2LA-HSL024AD	120	180	28	2	1	45.5	33.5	4 650	3 450	62.0	6 300	16 700	
5S-2LA-HSL026AD	130	200	33	2	1	65.0	46.5	6 650	4 750	85.5	8 750	15 200	

① Minimum allowable value for corner radius dimension  $r$  or  $r_1$ .  
 ② For the details of spacer dimensions, please contact NTN Engineering.



**Dynamic equivalent radial load**  $P_r = X F_r + Y F_a$

e	Single row / Tandem				Back-to-back / Face-to-face			
	$F_a / F_r \leq e$		$F_a / F_r > e$		$F_a / F_r \leq e$		$F_a / F_r > e$	
	X	Y	X	Y	X	Y	X	Y
0.68	1	0	0.41	0.87	1	0.92	0.67	1.41

**Static equivalent radial load**  $P_{or} = X_0 F_r + Y_0 F_a$

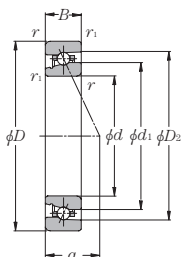
Single row / Tandem		Back-to-back / Face-to-face	
$X_0$	$Y_0$	$X_0$	$Y_0$
0.5	0.38	1	0.76

When  $P_{or} < F_r$  with single-row or tandem arrangement,  $P_{or} = F_r$ .

Load center mm	Mass kg Single-row (approx.)	Reference dimensions mm		Abutment and fillet dimensions mm				Part number
		$d_1$	$D_2$	$d_a$ min	$D_b$ max	$r_{ias}$ max	$t$ min	
23.3	0.22	60.1	73.2	55.5	75.5	0.6	8.5	5S-2LA-HSL010AD
26.1	0.35	67.6	80.8	62	85.5	0.6	8.5	5S-2LA-HSL011AD
27.2	0.38	72.6	85.8	67	90.5	0.6	8.5	5S-2LA-HSL012AD
28.4	0.40	77.6	90.8	72	95.5	0.6	9	5S-2LA-HSL013AD
31.1	0.57	84.8	99.1	77	105.5	0.6	9	5S-2LA-HSL014AD
32.3	0.60	89.8	104.1	82	110.5	0.6	9	5S-2LA-HSL015AD
35.1	0.82	96.8	112.5	87	120.5	0.6	9	5S-2LA-HSL016AD
36.2	0.85	101.8	117.4	92	125.5	0.6	9	5S-2LA-HSL017AD
39.0	1.12	108.8	125.8	98.5	134.5	1	9	5S-2LA-HSL018AD
40.2	1.17	113.8	130.8	103.5	139.5	1	9	5S-2LA-HSL019AD
41.3	1.22	118.8	135.8	108.5	144.5	1	9	5S-2LA-HSL020AD
44.1	1.55	125.8	144.1	115	154.5	1	9	5S-2LA-HSL021AD
46.9	1.89	132.4	153.2	120	164.5	1	9	5S-2LA-HSL022AD
49.2	2.03	142.4	163.2	130	174.5	1	9	5S-2LA-HSL024AD
55.3	2.98	155.5	181.5	140	194.5	1	9	5S-2LA-HSL026AD

## ULTAGE Eco-friendly angular contact ball bearings (ceramic ball type) 5S-2LA-HSFL0 series

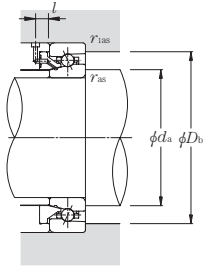
Contact angle 25°  $d$  50~100mm



Part number	Boundary dimensions						Basic load ratings				Static axial load capacity		Limiting speed min <sup>-1</sup> oil lubrication	
	mm						dynamic kN		dynamic kgf		kN			kgf
	$d$	$D$	$B$	$r_{3\text{ min}}$ <sup>①</sup>	$r_{18\text{ min}}$ <sup>①</sup>		$C_t$	$C_{or}$	$C_t$	$C_{or}$				
5S-2LA-HSFL010AD	50	80	16	1	0.6		10.1	6.20	1 030	635	11.4	1 170	50 000	
5S-2LA-HSFL011AD	55	90	18	1.1	0.6		12.6	7.80	1 280	800	14.4	1 470	44 800	
5S-2LA-HSFL012AD	60	95	18	1.1	0.6		12.9	8.45	1 320	860	15.5	1 580	41 900	
5S-2LA-HSFL013AD	65	100	18	1.1	0.6		13.3	9.05	1 360	925	16.7	1 700	39 400	
5S-2LA-HSFL014AD	70	110	20	1.1	0.6		16.2	11.1	1 650	1 130	20.4	2 080	36 100	
5S-2LA-HSFL015AD	75	115	20	1.1	0.6		16.7	11.9	1 700	1 210	21.8	2 220	34 200	
5S-2LA-HSFL016AD	80	125	22	1.1	0.6		19.9	14.2	2 030	1 440	26.0	2 660	31 700	
5S-2LA-HSFL017AD	85	130	22	1.1	0.6		20.1	14.7	2 050	1 500	27.0	2 750	30 200	
5S-2LA-HSFL018AD	90	140	24	1.5	1		24.5	18.2	2 500	1 860	33.5	3 400	28 300	
5S-2LA-HSFL019AD	95	145	24	1.5	1		24.7	18.8	2 520	1 920	34.5	3 550	27 100	
5S-2LA-HSFL020AD	100	150	24	1.5	1		25.3	20.0	2 580	2 040	37.0	3 750	26 000	

① Minimum allowable value for corner radius dimension  $r$  or  $r_1$ .

② For the details of spacer dimensions, please contact NTN Engineering.



**Dynamic equivalent radial load**  $P_r = XF_r + YF_a$

e	Single row / Tandem				Back-to-back / Face-to-face			
	$F_a/F_r \leq e$		$F_a/F_r > e$		$F_a/F_r \leq e$		$F_a/F_r > e$	
	X	Y	X	Y	X	Y	X	Y
0.68	1	0	0.41	0.87	1	0.92	0.67	1.41

**Static equivalent radial load**  $P_{or} = X_0 F_r + Y_0 F_a$

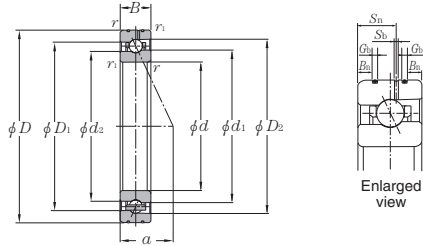
Single row / Tandem		Back-to-back / Face-to-face	
$X_0$	$Y_0$	$X_0$	$Y_0$
0.5	0.38	1	0.76

When  $P_{or} < F_r$  with single-row or tandem arrangement,  $P_{or} = F_r$ .

Load center mm	Mass kg Single-row (approx.)	Reference dimensions mm		Abutment and fillet dimensions mm				Part number
		$d_1$	$D_2$	$d_a$ min	$D_b$ max	$r_{1as}$ max	$l$ min	
23.3	0.27	61.6	70.9	55.5	75.5	0.6	8.5	5S-2LA-HSFL010AD
26.0	0.40	68.6	79.2	62	85.5	0.6	8.5	5S-2LA-HSFL011AD
27.2	0.43	73.6	84.2	67	90.5	0.6	8.5	5S-2LA-HSFL012AD
28.3	0.46	78.6	89.2	72	95.5	0.6	9	5S-2LA-HSFL013AD
31.1	0.64	85.6	97.5	77	105.5	0.6	9	5S-2LA-HSFL014AD
32.3	0.68	90.6	102.5	82	110.5	0.6	9	5S-2LA-HSFL015AD
35.0	0.91	97.6	110.8	87	120.5	0.6	9	5S-2LA-HSFL016AD
36.2	0.95	102.6	115.8	92	125.5	0.6	9	5S-2LA-HSFL017AD
39.0	1.25	109.8	124.2	98.5	134.5	1	9	5S-2LA-HSFL018AD
40.1	1.30	114.8	129.2	103.5	139.5	1	9	5S-2LA-HSFL019AD
41.3	1.36	119.8	134.2	108.5	144.5	1	9	5S-2LA-HSFL020AD

## ULTAGE Air-oil lubricated high-speed angular ball bearings with re-lubricating hole on the outer ring 5S-2LA-HSEW9U type

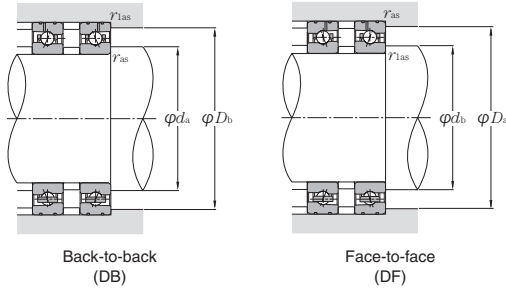
Contact angle  $20^\circ$   $d$  50~100mm



Part number	Boundary dimensions										Basic load ratings				Static axial load capacity		Limiting speed min <sup>-1</sup> oil lubrication
	mm										dynamic	static	dynamic	static	kN	kgf	
	$d$	$D$	$B$	$B_n$	$S_n$	$S_b$	$G_b$	$r$	$r_1$	$r_1$	kN	kN	kgf	kgf	(Static)		
5S-2LA-HSEW910U	50	72	12	2.2	6.6	1.2	1.3	0.6	0.3	0.3	10.7	5.50	1 090	560	8.55	875	46 100
5S-2LA-HSEW911U	55	80	13	2.8	7.2	1.2	1.3	1	0.6	0.6	13.3	6.85	1 360	700	10.6	1 090	41 700
5S-2LA-HSEW912U	60	85	13	2.8	7.2	1.2	1.3	1	0.6	0.6	13.8	7.50	1 410	765	11.6	1 190	38 800
5S-2LA-HSEW913U	65	90	13	2.8	7.2	1.2	1.3	1	0.6	0.6	13.9	7.85	1 420	800	12.2	1 250	36 300
5S-2LA-HSEW914U	70	100	16	3.1	9.3	1.4	1.9	1	0.6	0.6	20.4	11.2	2 080	1 140	17.4	1 780	33 100
5S-2LA-HSEW915U	75	105	16	3.1	9.3	1.4	1.9	1	0.6	0.6	21.2	12.2	2 160	1 240	19.0	1 940	31 300
5S-2LA-HSEW916U	80	110	16	3.1	9.3	1.4	1.9	1	0.6	0.6	21.4	12.7	2 190	1 290	19.8	2 020	29 600
5S-2LA-HSEW917U	85	120	18	4	10.4	1.6	1.9	1.1	0.6	0.6	29.1	16.8	2 960	1 710	26.1	2 670	27 400
5S-2LA-HSEW918U	90	125	18	4	10.4	1.6	1.9	1.1	0.6	0.6	30.0	18.1	3 100	1 850	28.3	2 890	26 200
5S-2LA-HSEW919U	95	130	18	4	10.4	1.6	1.9	1.1	0.6	0.6	30.5	18.9	3 100	1 930	29.4	3 000	25 000
5S-2LA-HSEW920U	100	140	20	4	12	1.6	1.9	1.1	0.6	0.6	35.5	22.1	3 600	2 260	34.0	3 500	23 400

① Minimum allowable value for corner radius dimension  $r$  or  $r_1$ .





**Dynamic equivalent radial load**  $P_r = XF_r + YF_a$

e	Single row / Tandem				Back-to-back / Face-to-face			
	$F_a/F_r \leq e$		$F_a/F_r > e$		$F_a/F_r \leq e$		$F_a/F_r > e$	
	X	Y	X	Y	X	Y	X	Y
0.57	1	0	0.43	1	1	1.09	0.7	1.63

**Static equivalent radial load**  $P_{or} = X_0 F_r + Y_0 F_a$

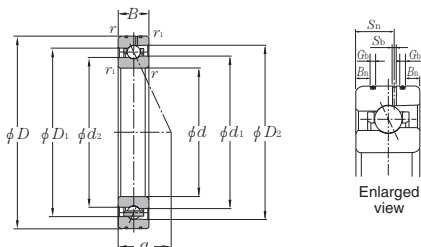
Single row / Tandem		Back-to-back / Face-to-face	
$X_0$	$Y_0$	$X_0$	$Y_0$
0.5	0.42	1	0.84

When  $P_{or} < F_r$  with single-row or tandem arrangement,  $P_{or} = F_r$ .

Load center mm	Internal free space cm <sup>3</sup> Single-row (approx.)	Mass kg Single-row (approx.)	Reference dimensions mm				Abutment and fillet dimensions mm					
			$d_1$	$d_2$	$D_1$	$D_2$	$d_a$ min	$d_b$ min	$D_a$ max	$D_b$ max	$r_{as}$ max	$r_{1as}$ max
17.2	6.0	0.12	57.6	56.6	64.4	66.8	54.5	52.5	67.5	69.5	0.6	0.3
18.9	7.7	0.17	63.6	62.4	71.4	74.1	60.5	59.5	74.5	75.5	1	0.6
19.8	8.3	0.18	68.6	67.4	76.4	79.1	65.5	64.5	79.5	80.5	1	0.6
20.7	8.9	0.19	73.6	72.4	81.4	84.0	70.5	69.5	84.5	85.5	1	0.6
23.6	14	0.31	80.1	78.6	89.8	93.2	75.5	74.5	94.5	95.5	1	0.6
24.5	15	0.33	85.1	83.6	94.8	98.2	80.5	79.5	99.5	100.5	1	0.6
25.4	16	0.34	90.1	88.6	99.8	103.2	85.5	84.5	104.5	105.5	1	0.6
27.8	22	0.48	96.8	94.9	108.2	112.3	92	89.5	113	115.5	1	0.6
28.7	23	0.51	101.8	99.9	113.2	117.3	97	94.5	118	120.5	1	0.6
29.6	24	0.53	106.8	104.9	118.2	122.3	102	99.5	123	125.5	1	0.6
32.0	32	0.74	113.8	111.7	126.2	130.6	107	104.5	133	135.5	1	0.6

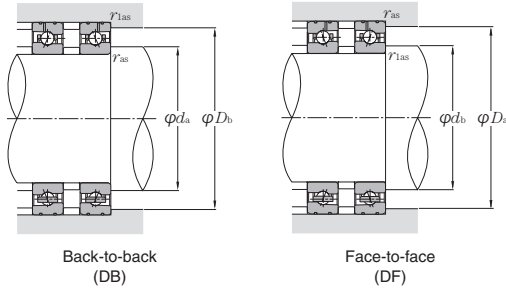
## ULTAGE Air-oil lubricated high-speed angular ball bearings with re-lubricating hole on the outer ring 5S-2LA-HSEW9U type

Contact angle 25°  $d$  50~100mm



Part number	Boundary dimensions									Basic load ratings				Static axial load capacity		Limiting speed min <sup>-1</sup> oil lubrication
	mm									dynamic	static	dynamic	static	kN	kgf	
	$d$	$D$	$B$	$B_n$	$S_n$	$S_b$	$G_b$	$r_{3\text{ min}}$	$r_{13\text{ min}}$	$C_r$	$C_{or}$	$C_r$	$C_{or}$			
5S-2LA-HSEW910UAD	50	72	12	2.2	6.6	1.2	1.3	0.6	0.3	10.3	5.30	1 050	545	9.75	995	41 000
5S-2LA-HSEW911UAD	55	80	13	2.8	7.2	1.2	1.3	1	0.6	12.9	6.65	1 310	680	12.1	1 240	37 000
5S-2LA-HSEW912UAD	60	85	13	2.8	7.2	1.2	1.3	1	0.6	13.3	7.3	1 360	740	13.3	1 360	34 500
5S-2LA-HSEW913UAD	65	90	13	2.8	7.2	1.2	1.3	1	0.6	13.5	7.6	1 370	775	13.9	1 420	32 300
5S-2LA-HSEW914UAD	70	100	16	3.1	9.3	1.4	1.9	1	0.6	19.7	10.8	2 010	1 100	19.9	2 030	29 400
5S-2LA-HSEW915UAD	75	105	16	3.1	9.3	1.4	1.9	1	0.6	20.5	11.8	2 090	1 200	21.5	2 200	27 800
5S-2LA-HSEW916UAD	80	110	16	3.1	9.3	1.4	1.9	1	0.6	20.7	12.3	2 110	1 250	22.5	2 300	26 300
5S-2LA-HSEW917UAD	85	120	18	4	10.4	1.6	1.9	1.1	0.6	28.1	16.2	2 860	1 660	29.4	3 000	24 400
5S-2LA-HSEW918UAD	90	125	18	4	10.4	1.6	1.9	1.1	0.6	29.2	17.6	2 980	1 790	31.5	3 250	23 300
5S-2LA-HSEW919UAD	95	130	18	4	10.4	1.6	1.9	1.1	0.6	29.5	18.3	3 000	1 870	33.0	3 400	22 200
5S-2LA-HSEW920UAD	100	140	20	4	12	1.6	1.9	1.1	0.6	34.5	21.4	3 500	2 190	39.0	4 000	20 800

① Minimum allowable value for corner radius dimension  $r$  or  $r_1$ .



**Dynamic equivalent radial load**  $P_r = XF_r + YF_a$

e	Single row / Tandem				Back-to-back / Face-to-face			
	$F_a/F_r \leq e$		$F_a/F_r > e$		$F_a/F_r \leq e$		$F_a/F_r > e$	
	X	Y	X	Y	X	Y	X	Y
0.68	1	0	0.41	0.87	1	0.92	0.67	1.41

**Static equivalent radial load**  $P_{or} = X_0 F_r + Y_0 F_a$

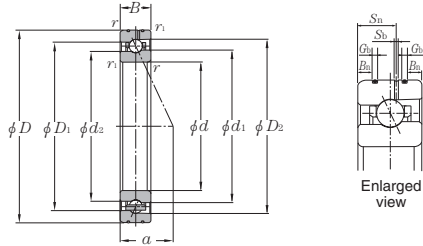
Single row / Tandem		Back-to-back / Face-to-face	
$X_0$	$Y_0$	$X_0$	$Y_0$
0.5	0.38	1	0.76

When  $P_{or} < F_r$  with single-row or tandem arrangement,  $P_{or} = F_r$ .

Load center mm	Internal free space cm <sup>3</sup> Single-row (approx.)	Mass kg Single-row (approx.)	Reference dimensions mm				Abutment and fillet dimensions mm					
			$d_1$	$d_2$	$D_1$	$D_2$	$d_a$ min	$d_b$ min	$D_a$ max	$D_b$ max	$r_{as}$ max	$r_{1as}$ max
20.3	6.0	0.12	57.6	56.6	64.4	66.7	54.5	52.5	67.5	69.5	0.6	0.3
22.4	7.7	0.17	63.6	62.4	71.4	74.1	60.5	59.5	74.5	75.5	1	0.6
23.5	8.3	0.18	68.6	67.4	76.4	79.0	65.5	64.5	79.5	80.5	1	0.6
24.7	8.9	0.19	73.6	72.4	81.4	84.0	70.5	69.5	84.5	85.5	1	0.6
28.0	14	0.31	80.1	78.6	89.8	93.2	75.5	74.5	94.5	95.5	1	0.6
29.1	15	0.33	85.1	83.6	94.8	98.2	80.5	79.5	99.5	100.5	1	0.6
30.3	16	0.34	90.1	88.6	99.8	103.2	85.5	84.5	104.5	105.5	1	0.6
33.1	22	0.48	96.8	94.9	108.2	112.3	92	89.5	113	115.5	1	0.6
34.2	23	0.51	101.8	99.9	113.2	117.3	97	94.5	118	120.5	1	0.6
35.4	24	0.53	106.8	104.9	118.2	122.3	102	99.5	123	125.5	1	0.6
38.2	32	0.74	113.8	111.7	126.2	130.6	107	104.5	133	135.5	1	0.6

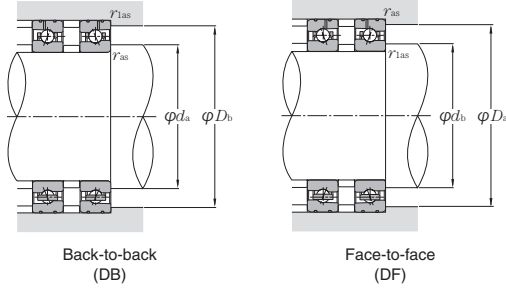
## ULTAGE Air-oil lubricated high-speed angular ball bearings with re-lubricating hole on the outer ring 5S-2LA-HSEW0 type

Contact angle  $20^\circ$   $d$  50~100mm



Part number	Boundary dimensions										Basic load ratings				Static axial load capacity		Limiting speed min <sup>-1</sup> oil lubrication		
	mm										dynamic	static	dynamic	static	kN	kgf		kN	kgf
	d	D	B	B <sub>n</sub>	S <sub>n</sub>	S <sub>b</sub>	G <sub>b</sub>	r <sub>3 min</sub> <sup>①</sup>	r <sub>15 min</sub> <sup>①</sup>		C <sub>r</sub>	C <sub>or</sub>	C <sub>r</sub>	C <sub>or</sub>					
5S-2LA-HSEW010	50	80	16	3.4	9.3	1.4	1.3	1	0.6		15.5	7.75	1 580	790	12.1	1 230	43 300		
5S-2LA-HSEW011	55	90	18	4.3	9.7	1.4	1.9	1.1	0.6		16.8	9.20	1 720	935	14.4	1 460	38 800		
5S-2LA-HSEW012	60	95	18	4.3	9.7	1.4	1.9	1.1	0.6		17.6	10.2	1 800	1 040	15.9	1 620	36 300		
5S-2LA-HSEW013	65	100	18	4	10.4	1.6	1.9	1.1	0.6		17.9	10.7	1 830	1 090	16.7	1 710	34 100		
5S-2LA-HSEW014	70	110	20	4	11.6	1.6	1.9	1.1	0.6		21.9	13.5	2 230	1 370	21.1	2 150	31 200		
5S-2LA-HSEW015	75	115	20	4	11.6	1.6	2.4	1.1	0.6		23.3	15.2	2 380	1 550	23.8	2 420	29 600		
5S-2LA-HSEW016	80	125	22	4.7	12.2	1.6	2.4	1.1	0.6		26.7	17.4	2 720	1 770	27.2	2 780	27 400		
5S-2LA-HSEW017	85	130	22	4.7	12.2	1.6	2.4	1.1	0.6		27.0	18.1	2 760	1 850	28.4	2 900	26 200		
5S-2LA-HSEW018	90	140	24	5.5	14.5	1.6	1.9	1.5	1		31.5	21.3	3 200	2 170	33.5	3 400	24 500		
5S-2LA-HSEW019	95	145	24	5.5	14.5	1.6	2.4	1.5	1		31.5	22.1	3 250	2 260	34.5	3 550	23 400		
5S-2LA-HSEW020	100	150	24	5.5	14.5	1.6	1.9	1.5	1		33.0	23.8	3 350	2 420	37.5	3 800	22 500		

① Minimum allowable value for corner radius dimension  $r$  or  $r_1$ .



**Dynamic equivalent radial load**  $P_r = XF_r + YF_a$

e	Single row / Tandem				Back-to-back / Face-to-face			
	$F_a/F_r \leq e$		$F_a/F_r > e$		$F_a/F_r \leq e$		$F_a/F_r > e$	
	X	Y	X	Y	X	Y	X	Y
0.57	1	0	0.43	1	1	1.09	0.7	1.63

**Static equivalent radial load**  $P_{or} = X_0 F_r + Y_0 F_a$

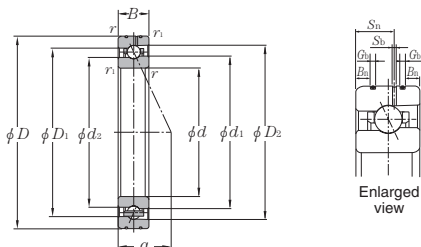
Single row / Tandem		Back-to-back / Face-to-face	
$X_0$	$Y_0$	$X_0$	$Y_0$
0.5	0.42	1	0.84

When  $P_{or} < F_r$  with single-row or tandem arrangement,  $P_{or} = F_r$ .

Load center mm	Internal free space cm <sup>3</sup> Single-row (approx.)	Mass kg Single-row (approx.)	Reference dimensions				Abutment and fillet dimensions					
			mm				mm					
			$d_1$	$d_2$	$D_1$	$D_2$	$d_a$ min	$d_b$ min	$D_a$ max	$D_b$ max	$r_{as}$ max	$r_{1as}$ max
19.9	12	0.23	60.1	58.6	69.9	73.2	55.5	54.5	74.5	75.5	1	0.6
22.3	16	0.37	67.6	66.2	77.4	80.8	62	59.5	83	85.5	1	0.6
23.2	17	0.40	72.6	71.2	82.4	85.8	67	64.5	88	90.5	1	0.6
24.1	18	0.42	77.6	76.2	87.4	90.8	72	69.5	93	95.5	1	0.6
26.5	24	0.60	84.8	83.0	95.2	99.1	77	74.5	103	105.5	1	0.6
27.4	25	0.64	89.8	88.0	100.2	104.1	82	79.5	108	110.5	1	0.6
29.8	34	0.86	96.8	94.9	108.2	112.5	87	84.5	118	120.5	1	0.6
30.7	35	0.90	101.8	99.9	113.2	117.4	92	89.5	123	125.5	1	0.6
33.1	45	1.18	108.8	106.7	121.2	125.8	98.5	95.5	131.5	134.5	1.5	1
34.0	47	1.23	113.8	111.7	126.2	130.8	103.5	100.5	136.5	139.5	1.5	1
34.9	49	1.28	118.8	116.7	131.2	135.8	108.5	105.5	141.5	144.5	1.5	1

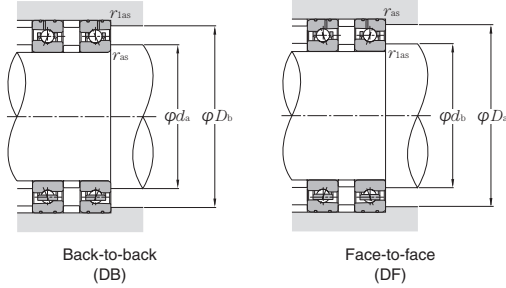
## ULTAGE Air-oil lubricated high-speed angular ball bearings with re-lubricating hole on the outer ring 5S-2LA-HSEW0 type

Contact angle 25°  $d$  50~100mm



Part number	Boundary dimensions										Basic load ratings				Static axial load capacity		Limiting speed min <sup>-1</sup> oil lubrication
	mm										dynamic kN	static kN	dynamic kgf	static kgf	(Static)		
	$d$	$D$	$B$	$B_n$	$S_n$	$S_b$	$G_b$	$r_{3\text{ min}}$	$r_{15\text{ min}}$	$r_1$	$C_r$	$C_{or}$	$C_r$	$C_{or}$			
5S-2LA-HSEW010AD	50	80	16	3.4	9.3	1.4	1.3	1	0.6	15.0	7.50	1 530	765	13.8	1 400	38 500	
5S-2LA-HSEW011AD	55	90	18	4.3	9.7	1.4	1.9	1.1	0.6	16.3	8.90	1 660	910	16.4	1 670	34 500	
5S-2LA-HSEW012AD	60	95	18	4.3	9.7	1.4	1.9	1.1	0.6	17.1	9.85	1 740	1 000	18.1	1 850	32 300	
5S-2LA-HSEW013AD	65	100	18	4	10.4	1.6	1.9	1.1	0.6	17.3	10.4	1 770	1 060	19.0	1 940	30 300	
5S-2LA-HSEW014AD	70	110	20	4	11.6	1.6	1.9	1.1	0.6	21.2	13.0	2 160	1 330	24.0	2 440	27 800	
5S-2LA-HSEW015AD	75	115	20	4	11.6	1.6	2.4	1.1	0.6	22.5	14.7	2 300	1 500	27.0	2 760	26 300	
5S-2LA-HSEW016AD	80	125	22	4.7	12.2	1.6	2.4	1.1	0.6	25.8	16.9	2 630	1 720	31.0	3 150	24 400	
5S-2LA-HSEW017AD	85	130	22	4.7	12.2	1.6	2.4	1.1	0.6	26.1	17.6	2 660	1 790	32.5	3 300	23 300	
5S-2LA-HSEW018AD	90	140	24	5.5	14.5	1.6	1.9	1.5	1	30.5	20.6	3 100	2 100	38.0	3 850	21 700	
5S-2LA-HSEW019AD	95	145	24	5.5	14.5	1.6	2.4	1.5	1	30.5	21.4	3 150	2 190	39.5	4 000	20 800	
5S-2LA-HSEW020AD	100	150	24	5.5	14.5	1.6	1.9	1.5	1	31.5	23.0	3 250	2 350	42.5	4 300	20 000	

① Minimum allowable value for corner radius dimension  $r$  or  $r_1$ .



### Dynamic equivalent radial load $P_r = XF_r + YF_a$

e	Single row / Tandem				Back-to-back / Face-to-face			
	$F_a/F_r \leq e$		$F_a/F_r > e$		$F_a/F_r \leq e$		$F_a/F_r > e$	
	X	Y	X	Y	X	Y	X	Y
0.68	1	0	0.41	0.87	1	0.92	0.67	1.41

### Static equivalent radial load $P_{or} = X_0 F_r + Y_0 F_a$

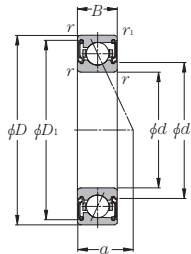
Single row / Tandem		Back-to-back / Face-to-face	
$X_0$	$Y_0$	$X_0$	$Y_0$
0.5	0.38	1	0.76

When  $P_{or} < F_r$  with single-row or tandem arrangement,  $P_{or} = F_r$ .

Load center mm	Internal free space cm <sup>3</sup> Single-row (approx.)	Mass kg Single-row (approx.)	Reference dimensions mm				Abutment and fillet dimensions mm					
			$d_1$	$d_2$	$D_1$	$D_2$	$d_a$ min	$d_b$ min	$D_a$ max	$D_b$ max	$r_{as}$ max	$r_{1as}$ max
23.3	12	0.23	60.1	58.6	69.9	73.2	55.5	54.5	74.5	75.5	1	0.6
26.1	16	0.37	67.6	66.2	77.4	80.8	62	59.5	83	85.5	1	0.6
27.2	17	0.40	72.6	71.2	82.4	85.8	67	64.5	88	90.5	1	0.6
28.4	18	0.40	77.6	76.2	87.4	90.8	72	69.5	93	95.5	1	0.6
31.1	24	0.60	84.8	83.0	95.2	99.1	77	74.5	103	105.5	1	0.6
32.3	25	0.64	89.8	88.0	100.2	104.1	82	79.5	108	110.5	1	0.6
35.1	34	0.86	96.8	94.9	108.2	112.5	87	84.5	118	120.5	1	0.6
36.2	35	0.90	101.8	99.9	113.2	117.4	92	89.5	123	125.5	1	0.6
39.0	45	1.18	108.8	106.7	121.2	125.8	98.5	95.5	131.5	134.5	1.5	1
40.2	47	1.23	113.8	111.7	126.2	130.8	103.5	100.5	136.5	139.5	1.5	1
41.3	49	1.28	118.8	116.7	131.2	135.8	108.5	105.5	141.5	144.5	1.5	1

## ULTAGE Sealed standard angular contact ball bearings (steel ball type) 79 LLB series

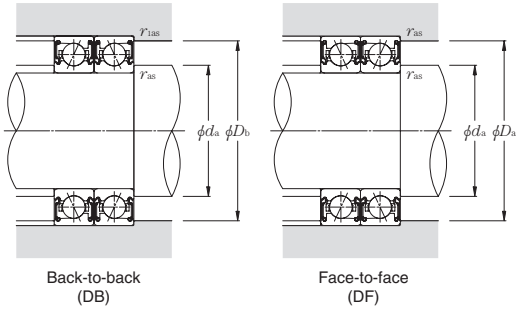
Contact angle 15°  $d$  10~50mm



Part number	Boundary dimensions					Basic load ratings				Static axial load capacity		Factor $f_o$	Limiting speed min <sup>-1</sup> grease lubrication
	mm					dynamic kN		static kgf		kN	kgf		
	$d$	$D$	$B$	$r_{3 \text{ min}}^{\text{①}}$	$r_{18 \text{ min}}^{\text{①}}$	$C_t$	$C_{or}$	$C_t$	$C_{or}$				
7900CDLLB	10	22	6	0.3	0.15	3.00	1.52	305	155	1.91	194	14.1	75 700
7901CDLLB	12	24	6	0.3	0.15	3.35	1.86	340	189	2.34	239	14.7	67 300
7902CDLLB	15	28	7	0.3	0.15	5.05	2.86	515	292	3.60	370	14.5	56 300
7903CDLLB	17	30	7	0.3	0.15	5.25	3.15	535	320	4.00	405	14.8	51 500
7904CDLLB	20	37	9	0.3	0.15	7.30	4.55	745	465	5.75	590	14.9	42 500
7905CDLLB	25	42	9	0.3	0.15	8.15	5.75	835	585	7.30	745	15.5	36 100
7906CDLLB	30	47	9	0.3	0.15	8.60	6.60	880	675	8.40	860	15.9	31 400
7907CDLLB	35	55	10	0.6	0.3	11.8	9.50	1 200	970	12.1	1 230	15.9	26 900
7908CDLLB	40	62	12	0.6	0.3	17.6	13.8	1 790	1 400	17.5	1 780	15.5	23 700
7909CDLLB	45	68	12	0.6	0.3	18.6	15.6	1 890	1 590	19.8	2 020	15.8	21 400
7910CDLLB	50	72	12	0.6	0.3	15.9	14.7	1 620	1 490	18.6	1 900	16.4	20 000

① Minimum allowable value for corner radius dimension  $r$  or  $r_1$ .





### Dynamic equivalent radial load

$$P_r = X F_r + Y F_a$$

$\frac{i \cdot f_0 \cdot F_a}{C_{Or}}$	e	Single row / Tandem				Back-to-back / Face-to-face				
		$F_d/F_r \leq e$		$F_d/F_r > e$		$F_d/F_r \leq e$		$F_d/F_r > e$		
		X	Y	X	Y	X	Y	X	Y	
0.178	0.38					1.47		1.65		2.39
0.357	0.4					1.4		1.57		2.28
0.714	0.43					1.3		1.46		2.11
1.07	0.46					1.23		1.38		2
1.43	0.47	1	0	0.44	1.19	1	1.34	0.72	1.93	
2.14	0.5				1.12		1.26		1.82	
3.57	0.55				1.02		1.14		1.66	
5.35	0.56				1		1.12		1.63	
7.14	0.56				1		1.12		1.63	

### Static equivalent radial load

$$P_{Or} = X_0 F_r + Y_0 F_a$$

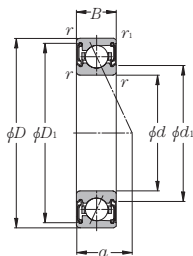
Single row / Tandem		Back-to-back / Face-to-face	
$X_0$	$Y_0$	$X_0$	$Y_0$
0.5	0.46	1	0.92

When  $P_{Or} < P_r$  with single-row or tandem arrangement,  $P_{Or} = P_r$ .

Load center mm	Mass kg Single-row (approx.)	Reference dimensions mm		Abutment and fillet dimensions					Part number
				mm					
				$d_a$ min	$D_a$ max	$D_b$ max	$r_{as}$ max	$r_{ias}$ max	
a		$d_1$	$D_1$						
5.2	0.010	12.9	19.7	12.5	19.7	20.8	0.3	0.15	7900CDLLB
5.4	0.012	15.2	21.7	14.5	21.7	22.8	0.3	0.15	7901CDLLB
6.4	0.017	18.5	26.0	17.5	26.0	26.8	0.3	0.15	7902CDLLB
6.7	0.019	20.2	28.0	19.5	28.0	28.8	0.3	0.15	7903CDLLB
8.4	0.039	23.9	33.9	22.5	34.5	35.8	0.3	0.15	7904CDLLB
9.0	0.046	29.1	38.9	27.5	39.5	40.8	0.3	0.15	7905CDLLB
9.7	0.053	34.6	43.9	32.5	44.5	45.8	0.3	0.15	7906CDLLB
11.1	0.081	40.2	51.2	39.5	51.2	52.5	0.6	0.3	7907CDLLB
12.9	0.11	45.3	58.8	44.5	58.8	59.5	0.6	0.3	7908CDLLB
13.6	0.13	50.8	64.3	49.5	64.3	65.5	0.6	0.3	7909CDLLB
14.2	0.14	55.2	67.5	54.5	67.5	69.5	0.6	0.3	7910CDLLB

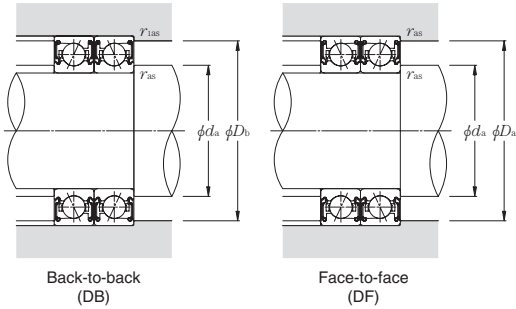
## ULTAGE Sealed standard angular contact ball bearings (steel ball type) 79 LLB series

Contact angle 25°  $d$  10~50mm



Part number	Boundary dimensions mm					Basic load ratings				Static axial load capacity		Limiting speed min <sup>-1</sup> grease lubrication
	$d$	$D$	$B$	$r_{3 \text{ min}}$ <sup>①</sup>	$r_{18 \text{ min}}$ <sup>①</sup>	dynamic kN	static kN	dynamic kgf	static kgf	kN	kgf	
7900ADLLB	10	22	6	0.3	0.15	2.88	1.45	294	148	2.20	225	65 600
7901ADLLB	12	24	6	0.3	0.15	3.20	1.77	325	181	2.61	267	58 300
7902ADLLB	15	28	7	0.3	0.15	4.80	2.74	490	279	4.40	450	48 800
7903ADLLB	17	30	7	0.3	0.15	5.00	3.00	510	305	4.75	485	44 700
7904ADLLB	20	37	9	0.3	0.15	6.95	4.35	710	445	6.35	645	36 800
7905ADLLB	25	42	9	0.3	0.15	7.75	5.50	790	560	7.75	790	31 300
7906ADLLB	30	47	9	0.3	0.15	8.15	6.30	830	640	8.65	885	27 300
7907ADLLB	35	55	10	0.6	0.3	11.1	9.00	1 130	920	13.1	1 340	23 300
7908ADLLB	40	62	12	0.6	0.3	16.7	13.1	1 700	1 330	19.3	1 960	20 600
7909ADLLB	45	68	12	0.6	0.3	17.6	14.8	1 790	1 510	21.5	2 190	18 600
7910ADLLB	50	72	12	0.6	0.3	15.0	13.9	1 530	1 420	13.6	1 380	17 400

① Minimum allowable value for corner radius dimension  $r$  or  $r_1$ .



**Dynamic equivalent radial load**  $P_r = X F_r + Y F_a$

e	Single row / Tandem				Back-to-back / Face-to-face			
	$F_a / F_r \leq e$		$F_a / F_r > e$		$F_a / F_r \leq e$		$F_a / F_r > e$	
	X	Y	X	Y	X	Y	X	Y
0.68	1	0	0.41	0.87	1	0.92	0.67	1.41

**Static equivalent radial load**  $P_{or} = X_0 F_r + Y_0 F_a$

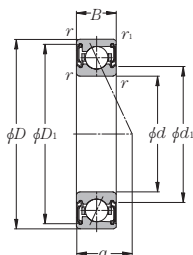
Single row / Tandem		Back-to-back / Face-to-face	
$X_0$	$Y_0$	$X_0$	$Y_0$
0.5	0.38	1	0.76

When  $P_{or} < F_r$  with single-row or tandem arrangement,  $P_{or} = F_r$ .

Load center mm	Mass kg Single-row (approx.)	Reference dimensions mm		Abutment and fillet dimensions mm					Part number
		$d_1$	$D_1$	$d_a$ min	$D_a$ max	$D_b$ max	$r_{as}$ max	$r_{1as}$ max	
6.8	0.010	12.9	19.7	12.5	19.7	20.8	0.3	0.15	7900ADLLB
7.2	0.012	15.2	21.7	14.5	21.7	22.8	0.3	0.15	7901ADLLB
8.6	0.017	18.5	26.0	17.5	26.0	26.8	0.3	0.15	7902ADLLB
9.0	0.019	20.2	28.0	19.5	28.0	28.8	0.3	0.15	7903ADLLB
11.2	0.039	23.9	33.9	22.5	34.5	35.8	0.3	0.15	7904ADLLB
12.4	0.046	29.1	38.9	27.5	39.5	40.8	0.3	0.15	7905ADLLB
13.5	0.053	34.6	43.9	32.5	44.5	45.8	0.3	0.15	7906ADLLB
15.6	0.081	40.2	51.2	39.5	51.2	52.5	0.6	0.3	7907ADLLB
18.0	0.11	45.3	58.8	44.5	58.8	59.5	0.6	0.3	7908ADLLB
19.3	0.13	50.8	64.3	49.5	64.3	65.5	0.6	0.3	7909ADLLB
20.2	0.14	55.2	67.5	54.5	67.5	69.5	0.6	0.3	7910ADLLB

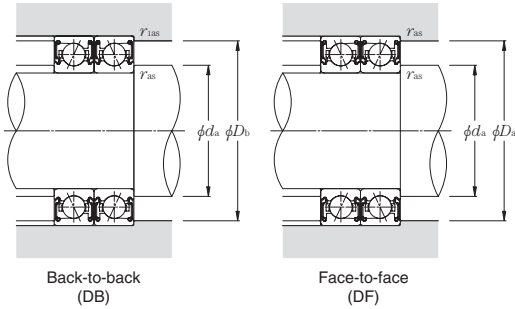
## ULTAGE Sealed standard angular contact ball bearings (steel ball type) 70 LLB series

Contact angle 15°  $d$  10~50mm



Part number	Boundary dimensions						Basic load ratings				Static axial load capacity		Factor	Limiting speed min <sup>-1</sup> grease lubrication
	mm						dynamic kN		dynamic kgf		kN	kgf		
	d	D	B	r <sub>s</sub> min <sup>①</sup>	r <sub>is</sub> min <sup>①</sup>	C <sub>r</sub>	C <sub>or</sub>	C <sub>r</sub>	C <sub>or</sub>					
7000CDLLB	10	26	8	0.3	0.15	5.30	2.49	540	254	3.10	315	12.6	67 300	
7001CDLLB	12	28	8	0.3	0.15	5.80	2.90	590	296	3.65	370	13.2	60 600	
7002CDLLB	15	32	9	0.3	0.15	6.25	3.40	635	345	4.25	435	14.0	51 500	
7003CDLLB	17	35	10	0.3	0.15	8.25	4.50	840	460	5.70	580	13.8	46 600	
7004CDLLB	20	42	12	0.6	0.3	10.5	6.00	1 070	610	7.55	770	14.0	39 100	
7005CDLLB	25	47	12	0.6	0.3	12.3	8.00	1 250	815	10.1	1 030	14.7	33 600	
7006CDLLB	30	55	13	1	0.6	15.1	10.3	1 540	1 050	13.0	1 320	14.9	28 500	
7007CDLLB	35	62	14	1	0.6	19.1	13.7	1 950	1 390	17.3	1 760	15.0	25 000	
7008CDLLB	40	68	15	1	0.6	20.6	15.9	2 100	1 620	20.1	2 050	15.4	22 400	
7009CDLLB	45	75	16	1	0.6	27.7	21.1	2 820	2 160	26.7	2 730	15.1	20 200	
7010CDLLB	50	80	16	1	0.6	28.6	22.9	2 910	2 330	29.0	2 960	15.4	18 600	

① Minimum allowable value for corner radius dimension  $r$  or  $r_1$ .



### Dynamic equivalent radial load

$$P_r = X F_r + Y F_a$$

$\frac{i \cdot f_0 \cdot F_a}{C_{Or}}$	$e$	Single row / Tandem				Back-to-back / Face-to-face				
		$F_d/F_r \leq e$		$F_d/F_r > e$		$F_d/F_r \leq e$		$F_d/F_r > e$		
		X	Y	X	Y	X	Y	X	Y	
0.178	0.38					1.47		1.65		2.39
0.357	0.4					1.4		1.57		2.28
0.714	0.43					1.3		1.46		2.11
1.07	0.46					1.23		1.38		2
1.43	0.47	1	0	0.44	1.19	1	1.34	0.72	1.93	
2.14	0.5				1.12		1.26		1.82	
3.57	0.55				1.02		1.14		1.66	
5.35	0.56				1		1.12		1.63	
7.14	0.56				1		1.12		1.63	

### Static equivalent radial load

$$P_{Or} = X_0 F_r + Y_0 F_a$$

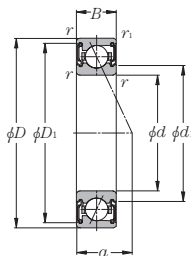
Single row / Tandem		Back-to-back / Face-to-face	
$X_0$	$Y_0$	$X_0$	$Y_0$
0.5	0.46	1	0.92

When  $P_{Or} < P_r$  with single-row or tandem arrangement,  $P_{Or} = P_r$ .

Load center mm	Mass kg Single-row (approx.)	Reference dimensions mm		Abutment and fillet dimensions					Part number
				mm					
				$d_a$ min	$D_a$ max	$D_b$ max	$r_{as}$ max	$r_{ias}$ max	
$a$		$d_1$	$D_1$						
6.4	0.018	14.5	23.4	12.5	23.5	24.8	0.3	0.15	7000CDLLB
6.7	0.022	16.5	25.4	14.5	25.5	26.8	0.3	0.15	7001CDLLB
7.7	0.032	19.5	28.8	17.5	29.5	30.8	0.3	0.15	7002CDLLB
8.5	0.040	21.6	32.2	19.5	32.5	33.8	0.3	0.15	7003CDLLB
10.2	0.070	26.0	38.0	24.5	38.0	39.5	0.6	0.3	7004CDLLB
10.9	0.083	30.4	43.1	29.5	43.1	44.5	0.6	0.3	7005CDLLB
12.2	0.11	36.4	50.4	35.5	50.4	50.5	1	0.6	7006CDLLB
13.6	0.16	41.9	57.2	40.5	57.2	57.5	1	0.6	7007CDLLB
14.8	0.19	47.9	62.7	45.5	62.7	63.5	1	0.6	7008CDLLB
16.1	0.24	53.0	70.3	50.5	70.3	70.5	1	0.6	7009CDLLB
16.8	0.26	58.0	75.3	55.5	75.3	75.5	1	0.6	7010CDLLB

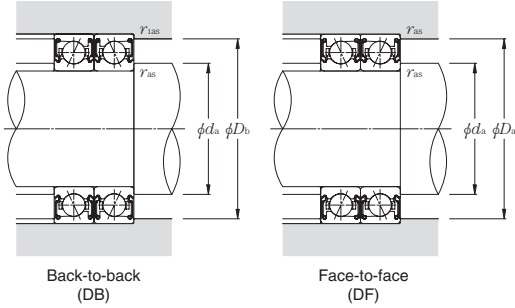
## ULTAGE Sealed standard angular contact ball bearings (steel ball type) 70 LLB series

Contact angle 25°  $d$  10~50mm



Part number	Boundary dimensions mm					Basic load ratings				Static axial load capacity		Limiting speed min <sup>-1</sup> grease lubrication
	$d$	$D$	$B$	$r_{18 \text{ min}}$ ①	$r_{18 \text{ min}}$ ①	dynamic kN		static kgf		kN	kgf	
						$C_r$	$C_{or}$	$C_r$	$C_{or}$			
7000ADLLB	10	26	8	0.3	0.15	5.15	2.41	525	245	3.85	395	58 300
7001ADLLB	12	28	8	0.3	0.15	5.60	2.79	570	285	4.50	455	52 500
7002ADLLB	15	32	9	0.3	0.15	5.95	3.25	610	330	4.95	505	44 700
7003ADLLB	17	35	10	0.3	0.15	7.90	4.35	805	445	6.95	710	40 400
7004ADLLB	20	42	12	0.6	0.3	10.0	5.75	1 020	585	8.80	900	33 900
7005ADLLB	25	47	12	0.6	0.3	11.7	7.65	1 190	780	11.3	1 150	29 200
7006ADLLB	30	55	13	1	0.6	14.4	9.80	1 470	995	14.9	1 520	24 700
7007ADLLB	35	62	14	1	0.6	18.2	13.0	1 850	1 330	20.4	2 080	21 600
7008ADLLB	40	68	15	1	0.6	19.5	15.1	1 990	1 540	23.2	2 370	19 400
7009ADLLB	45	75	16	1	0.6	26.3	20.1	2 680	2 050	31.0	3 150	17 500
7010ADLLB	50	80	16	1	0.6	27.1	21.8	2 760	2 220	33.0	3 350	16 200

① Minimum allowable value for corner radius dimension  $r$  or  $r_1$ .



**Dynamic equivalent radial load**  $P_r = X F_r + Y F_a$

e	Single row / Tandem				Back-to-back / Face-to-face			
	$F_a / F_r \leq e$		$F_a / F_r > e$		$F_a / F_r \leq e$		$F_a / F_r > e$	
	X	Y	X	Y	X	Y	X	Y
0.68	1	0	0.41	0.87	1	0.92	0.67	1.41

**Static equivalent radial load**  $P_{or} = X_o F_r + Y_o F_a$

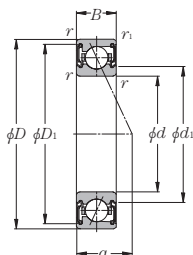
Single row / Tandem		Back-to-back / Face-to-face	
$X_o$	$Y_o$	$X_o$	$Y_o$
0.5	0.38	1	0.76

When  $P_{or} < F_r$  with single-row or tandem arrangement,  $P_{or} = F_r$ .

Load center mm	Mass kg Single-row (approx.)	Reference dimensions mm		Abutment and fillet dimensions						Part number
				mm						
				$d_a$ min	$D_a$ max	$D_b$ max	$r_{as}$ max	$r_{1as}$ max		
a		$d_1$	$D_1$							
8.3	0.018	14.5	23.4	12.5	23.5	24.8	0.3	0.15	<b>7000ADLLB</b>	
8.7	0.022	16.5	25.4	14.5	25.5	26.8	0.3	0.15	<b>7001ADLLB</b>	
10.0	0.032	19.5	28.8	17.5	29.5	30.8	0.3	0.15	<b>7002ADLLB</b>	
11.1	0.040	21.6	32.2	19.5	32.5	33.8	0.3	0.15	<b>7003ADLLB</b>	
13.3	0.070	26.0	38.0	24.5	38.0	39.5	0.6	0.3	<b>7004ADLLB</b>	
14.5	0.083	30.4	43.1	29.5	43.1	44.5	0.6	0.3	<b>7005ADLLB</b>	
16.5	0.11	36.4	50.4	35.5	50.4	50.5	1	0.6	<b>7006ADLLB</b>	
18.4	0.16	41.9	57.2	40.5	57.2	57.5	1	0.6	<b>7007ADLLB</b>	
20.2	0.19	47.9	62.7	45.5	62.7	63.5	1	0.6	<b>7008ADLLB</b>	
22.1	0.24	53.0	70.3	50.5	70.3	70.5	1	0.6	<b>7009ADLLB</b>	
23.3	0.26	58.0	75.3	55.5	75.3	75.5	1	0.6	<b>7010ADLLB</b>	

## ULTAGE Sealed standard angular contact ball bearings (ceramic ball type) 5S-79 LLB series

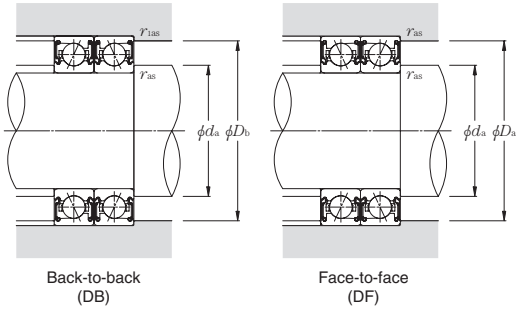
Contact angle 15°  $d$  10~50mm



Part number	Boundary dimensions mm					Basic load ratings				Static axial load capacity		Factor $f_o$	Limiting speed min <sup>-1</sup> grease lubrication
	$d$	$D$	$B$	$r_3$ min <sup>①</sup>	$r_{18}$ min <sup>①</sup>	dynamic kN		static kgf		kN	kgf		
						$C_r$	$C_{or}$	$C_r$	$C_{or}$				
5S-7900CDLLB	10	22	6	0.3	0.15	3.00	1.05	305	107	1.19	121	9.8	89 800
5S-7901CDLLB	12	24	6	0.3	0.15	3.35	1.29	340	131	1.46	149	10.2	79 800
5S-7902CDLLB	15	28	7	0.3	0.15	5.05	1.98	515	202	2.25	230	10.0	66 800
5S-7903CDLLB	17	30	7	0.3	0.15	5.25	2.19	535	223	2.49	254	10.3	61 100
5S-7904CDLLB	20	37	9	0.3	0.15	7.30	3.15	745	325	3.60	365	10.3	50 400
5S-7905CDLLB	25	42	9	0.3	0.15	8.15	4.00	835	405	4.55	465	10.7	42 900
5S-7906CDLLB	30	47	9	0.3	0.15	8.60	4.60	880	470	5.25	535	11.0	37 300
5S-7907CDLLB	35	55	10	0.6	0.3	11.8	6.60	1 200	670	7.55	770	11.0	31 900
5S-7908CDLLB	40	62	12	0.6	0.3	17.6	9.55	1 790	975	10.9	1 110	10.8	28 200
5S-7909CDLLB	45	68	12	0.6	0.3	18.6	10.8	1 890	1 100	12.4	1 260	11.0	24 100
5S-7910CDLLB	50	72	12	0.6	0.3	15.9	10.2	1 620	1 040	11.7	1 190	11.3	22 500

① Minimum allowable value for corner radius dimension  $r$  or  $r_1$ .





### Dynamic equivalent radial load

$$P_r = X F_r + Y F_a$$

$\frac{i \cdot f_0 \cdot F_a}{C_{Or}}$	$e$	Single row / Tandem				Back-to-back / Face-to-face				
		$F_d/F_r \leq e$		$F_d/F_r > e$		$F_d/F_r \leq e$		$F_d/F_r > e$		
		X	Y	X	Y	X	Y	X	Y	
0.178	0.38					1.47		1.65		2.39
0.357	0.4					1.4		1.57		2.28
0.714	0.43					1.3		1.46		2.11
1.07	0.46					1.23		1.38		2
1.43	0.47	1	0	0.44	1.19	1	1.34	0.72	1.93	
2.14	0.5					1.12		1.26		1.82
3.57	0.55					1.02		1.14		1.66
5.35	0.56					1		1.12		1.63
7.14	0.56					1		1.12		1.63

### Static equivalent radial load

$$P_{Or} = X_0 F_r + Y_0 F_a$$

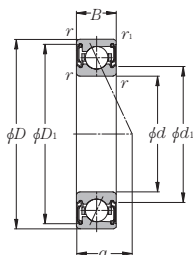
$X_0$	$Y_0$	Back-to-back / Face-to-face	
		$X_0$	$Y_0$
0.5	0.46	1	0.92

When  $P_{Or} < P_r$  with single-row or tandem arrangement,  $P_{Or} = P_r$ .

Load center mm	Mass kg Single-row (approx.)	Reference dimensions mm		Abutment and fillet dimensions					Part number
				mm					
				$d_a$ min	$D_a$ max	$D_b$ max	$r_{as}$ max	$r_{ias}$ max	
$a$		$d_1$	$D_1$						
5.2	0.009	12.9	19.7	12.5	19.7	20.8	0.3	0.15	5S-7900CDLLB
5.4	0.011	15.2	21.7	14.5	21.7	22.8	0.3	0.15	5S-7901CDLLB
6.4	0.015	18.5	26.0	17.5	26.0	26.8	0.3	0.15	5S-7902CDLLB
6.7	0.017	20.2	28.0	19.5	28.0	28.8	0.3	0.15	5S-7903CDLLB
8.4	0.036	23.9	33.9	22.5	34.5	35.8	0.3	0.15	5S-7904CDLLB
9.0	0.042	29.1	38.9	27.5	39.5	40.8	0.3	0.15	5S-7905CDLLB
9.7	0.048	34.6	43.9	32.5	44.5	45.8	0.3	0.15	5S-7906CDLLB
11.1	0.073	40.2	51.2	39.5	51.2	52.5	0.6	0.3	5S-7907CDLLB
12.9	0.099	45.3	58.8	44.5	58.8	59.5	0.6	0.3	5S-7908CDLLB
13.6	0.12	50.8	64.3	49.5	64.3	65.5	0.6	0.3	5S-7909CDLLB
14.2	0.12	55.2	67.5	54.5	67.5	69.5	0.6	0.3	5S-7910CDLLB

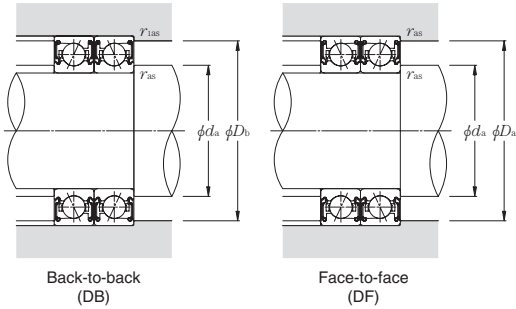
## ULTAGE Sealed standard angular contact ball bearings (ceramic ball type) 5S-79 LLB series

Contact angle 25°  $d$  10~50mm



Part number	Boundary dimensions mm					Basic load ratings				Static axial load capacity		Limiting speed min <sup>-1</sup> grease lubrication
	$d$	$D$	$B$	$r_{3 \text{ min}}$ <sup>①</sup>	$r_{18 \text{ min}}$ <sup>①</sup>	dynamic kN	static kN	dynamic kgf	static kgf	kN	kgf	
5S-7900ADLLB	10	22	6	0.3	0.15	2.88	1.01	294	103	1.52	155	79 700
5S-7901ADLLB	12	24	6	0.3	0.15	3.20	1.23	325	125	1.86	189	70 800
5S-7902ADLLB	15	28	7	0.3	0.15	4.80	1.90	490	193	2.86	292	59 300
5S-7903ADLLB	17	30	7	0.3	0.15	5.00	2.09	510	213	3.15	320	54 300
5S-7904ADLLB	20	37	9	0.3	0.15	6.95	3.00	710	310	4.55	465	44 700
5S-7905ADLLB	25	42	9	0.3	0.15	7.75	3.80	790	385	5.75	585	38 100
5S-7906ADLLB	30	47	9	0.3	0.15	8.15	4.35	830	445	6.60	670	33 100
5S-7907ADLLB	35	55	10	0.6	0.3	11.1	6.25	1 130	635	9.45	965	28 300
5S-7908ADLLB	40	62	12	0.6	0.3	16.7	9.05	1 700	925	13.7	1 400	25 000
5S-7909ADLLB	45	68	12	0.6	0.3	17.6	10.3	1 790	1 050	15.6	1 590	21 400
5S-7910ADLLB	50	72	12	0.6	0.3	15.0	9.60	1 530	980	14.6	1 490	20 000

① Minimum allowable value for corner radius dimension  $r$  or  $r_1$ .



**Dynamic equivalent radial load**  $P_r = X F_r + Y F_a$

e	Single row / Tandem				Back-to-back / Face-to-face			
	$F_a / F_r \leq e$		$F_a / F_r > e$		$F_a / F_r \leq e$		$F_a / F_r > e$	
	X	Y	X	Y	X	Y	X	Y
0.68	1	0	0.41	0.87	1	0.92	0.67	1.41

**Static equivalent radial load**  $P_{or} = X_0 F_r + Y_0 F_a$

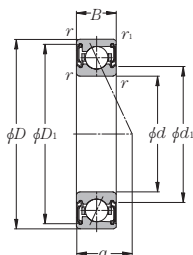
Single row / Tandem		Back-to-back / Face-to-face	
$X_0$	$Y_0$	$X_0$	$Y_0$
0.5	0.38	1	0.76

When  $P_{or} < F_r$  with single-row or tandem arrangement,  $P_{or} = F_r$ .

Load center mm	Mass kg Single-row (approx.)	Reference dimensions mm		Abutment and fillet dimensions					Part number
				mm					
				$d_a$ min	$D_a$ max	$D_b$ max	$r_{as}$ max	$r_{1as}$ max	
6.8	0.009	12.9	19.7	12.5	19.7	20.8	0.3	0.15	5S-7900ADLLB
7.2	0.011	15.2	21.7	14.5	21.7	22.8	0.3	0.15	5S-7901ADLLB
8.6	0.015	18.5	26.0	17.5	26.0	26.8	0.3	0.15	5S-7902ADLLB
9.0	0.017	20.2	28.0	19.5	28.0	28.8	0.3	0.15	5S-7903ADLLB
11.2	0.036	23.9	33.9	22.5	34.5	35.8	0.3	0.15	5S-7904ADLLB
12.4	0.042	29.1	38.9	27.5	39.5	40.8	0.3	0.15	5S-7905ADLLB
13.5	0.048	34.6	43.9	32.5	44.5	45.8	0.3	0.15	5S-7906ADLLB
15.6	0.073	40.2	51.2	39.5	51.2	52.5	0.6	0.3	5S-7907ADLLB
18.0	0.099	45.3	58.8	44.5	58.8	59.5	0.6	0.3	5S-7908ADLLB
19.3	0.12	50.8	64.3	49.5	64.3	65.5	0.6	0.3	5S-7909ADLLB
20.2	0.12	55.2	67.5	54.5	67.5	69.5	0.6	0.3	5S-7910ADLLB

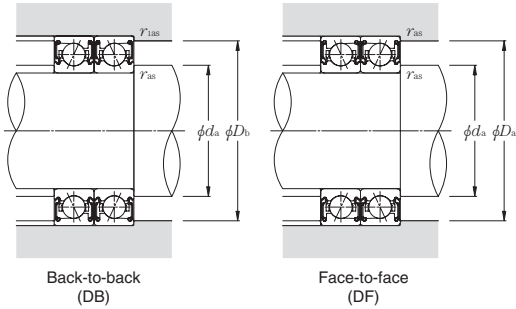
## ULTAGE Sealed standard angular contact ball bearings (ceramic ball type) 5S-70 LLB series

Contact angle 15°  $d$  10~50mm



Part number	Boundary dimensions mm					Basic load ratings				Static axial load capacity		Factor $f_o$	Limiting speed min <sup>-1</sup> grease lubrication
	$d$	$D$	$B$	$r_{3\text{ min}}$ <sup>①</sup>	$r_{18\text{ min}}$ <sup>①</sup>	dynamic kN	static kN	dynamic kgf	static kgf	kN	kgf		
5S-7000CDLLB	10	26	8	0.3	0.15	5.30	1.73	540	176	1.93	197	8.8	80 600
5S-7001CDLLB	12	28	8	0.3	0.15	5.80	2.01	590	205	2.26	231	9.2	72 600
5S-7002CDLLB	15	32	9	0.3	0.15	6.25	2.35	635	239	2.66	271	9.7	61 800
5S-7003CDLLB	17	35	10	0.3	0.15	8.25	3.15	840	320	3.55	360	9.6	55 800
5S-7004CDLLB	20	42	12	0.6	0.3	10.5	4.15	1 070	425	4.70	480	9.7	46 800
5S-7005CDLLB	25	47	12	0.6	0.3	12.3	5.55	1 250	565	6.30	640	10.2	40 300
5S-7006CDLLB	30	55	13	1	0.6	15.1	7.10	1 540	725	8.10	825	10.3	34 100
5S-7007CDLLB	35	62	14	1	0.6	19.1	9.45	1 950	965	10.8	1 100	10.4	29 900
5S-7008CDLLB	40	68	15	1	0.6	20.6	11.0	2 100	1 120	12.6	1 280	10.6	26 900
5S-7009CDLLB	45	75	16	1	0.6	27.7	14.6	2 820	1 490	16.7	1 700	10.4	23 300
5S-7010CDLLB	50	80	16	1	0.6	28.6	15.9	2 910	1 620	18.1	1 850	10.6	21 500

① Minimum allowable value for corner radius dimension  $r$  or  $r_1$ .



### Dynamic equivalent radial load

$$P_r = X F_r + Y F_a$$

$\frac{i \cdot f_0 \cdot F_a}{C_{Or}}$	e	Single row / Tandem				Back-to-back / Face-to-face			
		$F_d/F_r \leq e$		$F_d/F_r > e$		$F_d/F_r \leq e$		$F_d/F_r > e$	
		X	Y	X	Y	X	Y	X	Y
0.178	0.38			1.47		1.65		2.39	
0.357	0.4			1.4		1.57		2.28	
0.714	0.43			1.3		1.46		2.11	
1.07	0.46			1.23		1.38		2	
1.43	0.47	1	0	1.19	1	1.34	0.72	1.93	
2.14	0.5			1.12		1.26		1.82	
3.57	0.55			1.02		1.14		1.66	
5.35	0.56			1		1.12		1.63	
7.14	0.56			1		1.12		1.63	

### Static equivalent radial load

$$P_{Or} = X_0 F_r + Y_0 F_a$$

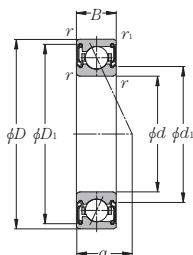
Single row / Tandem		Back-to-back / Face-to-face	
$X_0$	$Y_0$	$X_0$	$Y_0$
0.5	0.46	1	0.92

When  $P_{Or} < P_r$  with single-row or tandem arrangement,  $P_{Or} = P_r$ .

Load center mm	Mass kg Single-row (approx.)	Reference dimensions mm		Abutment and fillet dimensions mm					Part number
		$d_1$	$D_1$	$d_a$ min	$D_a$ max	$D_b$ max	$r_{as}$ max	$r_{ias}$ max	
6.4	0.014	14.5	23.4	12.5	23.5	24.8	0.3	0.15	5S-7000CDLLB
6.7	0.020	16.5	25.4	14.5	25.5	26.8	0.3	0.15	5S-7001CDLLB
7.7	0.029	19.5	28.8	17.5	29.5	30.8	0.3	0.15	5S-7002CDLLB
8.5	0.035	21.6	32.2	19.5	32.5	33.8	0.3	0.15	5S-7003CDLLB
10.2	0.064	26.0	38.0	24.5	38.0	39.5	0.6	0.3	5S-7004CDLLB
10.9	0.075	30.4	43.1	29.5	43.1	44.5	0.6	0.3	5S-7005CDLLB
12.2	0.096	36.4	50.4	35.5	50.4	50.5	1	0.6	5S-7006CDLLB
13.6	0.14	41.9	57.2	40.5	57.2	57.5	1	0.6	5S-7007CDLLB
14.8	0.17	47.9	62.7	45.5	62.7	63.5	1	0.6	5S-7008CDLLB
16.1	0.21	53.0	70.3	50.5	70.3	70.5	1	0.6	5S-7009CDLLB
16.8	0.23	58.0	75.3	55.5	75.3	75.5	1	0.6	5S-7010CDLLB

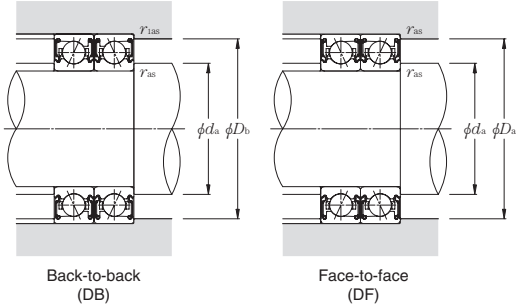
## ULTAGE Sealed standard angular contact ball bearings (ceramic ball type) 5S-70 LLB series

Contact angle 25°  $d$  10~50mm



Part number	Boundary dimensions						Basic load ratings				Static axial load capacity		Limiting speed min <sup>-1</sup> grease lubrication
	mm						dynamic	static	dynamic	static	kN	kgf	
	$d$	$D$	$B$	$r_{3 \text{ min}}$ ①	$r_{18 \text{ min}}$ ①		$C_t$	$C_{or}$	$C_t$	$C_{or}$			
5S-7000ADLLB	10	26	8	0.3	0.15	5.15	1.67	525	170	2.51	256	70 600	
5S-7001ADLLB	12	28	8	0.3	0.15	5.60	1.93	570	197	2.92	297	63 500	
5S-7002ADLLB	15	32	9	0.3	0.15	5.95	2.25	610	229	3.40	345	54 000	
5S-7003ADLLB	17	35	10	0.3	0.15	7.90	3.00	805	305	4.55	465	48 800	
5S-7004ADLLB	20	42	12	0.6	0.3	10.0	4.00	1 020	405	6.00	615	41 000	
5S-7005ADLLB	25	47	12	0.6	0.3	11.7	5.30	1 190	540	8.00	815	35 300	
5S-7006ADLLB	30	55	13	1	0.6	14.4	6.80	1 470	690	10.2	1 040	29 900	
5S-7007ADLLB	35	62	14	1	0.6	18.2	9.00	1 850	920	13.6	1 390	26 200	
5S-7008ADLLB	40	68	15	1	0.6	19.5	10.5	1 990	1 070	15.8	1 620	23 500	
5S-7009ADLLB	45	75	16	1	0.6	26.3	14.0	2 680	1 420	21.1	2 150	20 300	
5S-7010ADLLB	50	80	16	1	0.6	27.1	15.1	2 760	1 540	22.8	2 330	18 800	

① Minimum allowable value for corner radius dimension  $r$  or  $r_1$ .



**Dynamic equivalent radial load**  $P_r = X F_r + Y F_a$

e	Single row / Tandem				Back-to-back / Face-to-face			
	$F_a / F_r \leq e$		$F_a / F_r > e$		$F_a / F_r \leq e$		$F_a / F_r > e$	
	X	Y	X	Y	X	Y	X	Y
0.68	1	0	0.41	0.87	1	0.92	0.67	1.41

**Static equivalent radial load**  $P_{or} = X_0 F_r + Y_0 F_a$

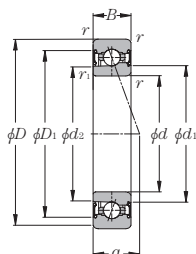
Single row / Tandem		Back-to-back / Face-to-face	
$X_0$	$Y_0$	$X_0$	$Y_0$
0.5	0.38	1	0.76

When  $P_{or} < F_r$  with single-row or tandem arrangement,  $P_{or} = F_r$ .

Load center mm	Mass kg Single-row (approx.)	Reference dimensions mm		Abutment and fillet dimensions mm					Part number
		$d_1$	$D_1$	$d_a$ min	$D_a$ max	$D_b$ max	$r_{as}$ max	$r_{1as}$ max	
8.3	0.014	14.5	23.4	12.5	23.5	24.8	0.3	0.15	5S-7000ADLLB
8.7	0.020	16.5	25.4	14.5	25.5	26.8	0.3	0.15	5S-7001ADLLB
10.0	0.029	19.5	28.8	17.5	29.5	30.8	0.3	0.15	5S-7002ADLLB
11.1	0.035	21.6	32.2	19.5	32.5	33.8	0.3	0.15	5S-7003ADLLB
13.3	0.064	26.0	38.0	24.5	38.0	39.5	0.6	0.3	5S-7004ADLLB
14.5	0.075	30.4	43.1	29.5	43.1	44.5	0.6	0.3	5S-7005ADLLB
16.5	0.096	36.4	50.4	35.5	50.4	50.5	1	0.6	5S-7006ADLLB
18.4	0.14	41.9	57.2	40.5	57.2	57.5	1	0.6	5S-7007ADLLB
20.2	0.17	47.9	62.7	45.5	62.7	63.5	1	0.6	5S-7008ADLLB
22.1	0.21	53.0	70.3	50.5	70.3	70.5	1	0.6	5S-7009ADLLB
23.3	0.23	58.0	75.3	55.5	75.3	75.5	1	0.6	5S-7010ADLLB

## ULTAGE Sealed high-speed angular contact ball bearings (steel ball type) 2LA-BNS9 LLB series

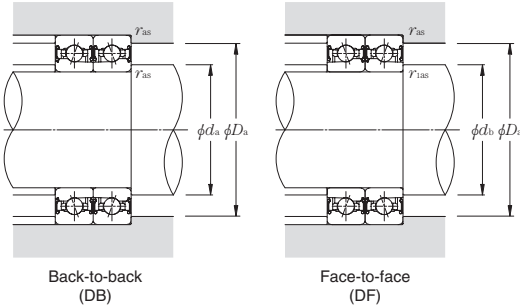
Contact angle 15°  $d$  50~100mm



Part number	Boundary dimensions mm						Basic load ratings				Static axial load capacity		Factor $f_0$	Limiting speed min <sup>-1</sup> grease lubrication
	$d$	$D$	$B$	$r_{18 \text{ min}}$ <sup>①</sup>	$r_{18 \text{ min}}$ <sup>①</sup>		dynamic kN	static kN	dynamic kgf	static kgf	kN	kgf		
2LA-BNS910CLLB	50	72	12	0.6	0.3		8.10	7.30	825	745	10.7	1 090	11.1	21 800
2LA-BNS911CLLB	55	80	13	1	0.6		10.3	9.20	1 050	940	13.5	1 380	11.0	19 700
2LA-BNS912CLLB	60	85	13	1	0.6		10.6	10.0	1 080	1 010	14.6	1 490	11.1	18 300
2LA-BNS913CLLB	65	90	13	1	0.6		10.9	10.7	1 110	1 090	15.7	1 600	11.2	17 200
2LA-BNS914CLLB	70	100	16	1	0.6		13.7	13.5	1 400	1 370	19.8	2 020	11.1	15 600
2LA-BNS915CLLB	75	105	16	1	0.6		14.1	14.4	1 440	1 470	21.2	2 170	11.2	14 800
2LA-BNS916CLLB	80	110	16	1	0.6		14.5	15.4	1 480	1 570	22.6	2 310	11.3	14 000
2LA-BNS917CLLB	85	120	18	1.1	0.6		17.4	18.3	1 770	1 860	26.9	2 740	11.2	13 000
2LA-BNS918CLLB	90	125	18	1.1	0.6		17.9	19.5	1 820	1 980	28.7	2 920	11.3	12 400
2LA-BNS919CLLB	95	130	18	1.1	0.6		18.3	20.6	1 870	2 110	30.5	3 100	11.3	11 800
2LA-BNS920CLLB	100	140	20	1.1	0.6		25.7	28.0	2 620	2 850	41.0	4 200	11.2	11 100

① Minimum allowable value for corner radius dimension  $r$  or  $r_1$ .





### Dynamic equivalent radial load

$$P_r = X F_r + Y F_a$$

$\frac{i \cdot f_0 \cdot F_a}{C_{Or}}$	e	Single row / Tandem				Back-to-back / Face-to-face			
		$F_d/F_r \leq e$		$F_d/F_r > e$		$F_d/F_r \leq e$		$F_d/F_r > e$	
		X	Y	X	Y	X	Y	X	Y
0.178	0.35					1.57	1.76		2.56
0.357	0.36					1.53	1.71		2.48
0.714	0.38					1.46	1.64		2.38
1.07	0.4					1.42	1.59		2.31
1.43	0.41	1	0	0.44	1.38	1	1.55	0.72	2.25
2.14	0.43				1.33	1.49			2.16
3.57	0.44				1.25	1.4			2.03
5.35	0.47				1.18	1.32			1.92
7.14	0.49				1.13	1.26			1.83

### Static equivalent radial load

$$P_{Or} = X_0 F_r + Y_0 F_a$$

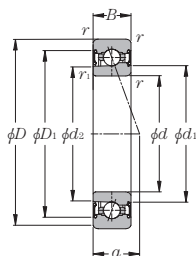
Single row / Tandem		Back-to-back / Face-to-face	
$X_0$	$Y_0$	$X_0$	$Y_0$
0.52	0.54	1.04	1.08

When  $P_{Or} < F_r$  with single-row or tandem arrangement,  $P_{Or} = F_r$ .

Load center mm	Mass kg Single-row (approx.)	Reference dimensions mm			Abutment and fillet dimensions mm					Part number
		$d_1$	$d_2$	$D_1$	$d_a$ min	$d_b$ min	$D_a$ max	$r_{as}$ max	$r_{ias}$ max	
14.2	0.14	56.9	56.0	65.0	54.5	52.5	67.5	0.6	0.3	2LA-BNS910CLLB
15.6	0.19	62.6	61.7	72.1	60.5	59.5	74.5	1	0.6	2LA-BNS911CLLB
16.3	0.21	67.6	66.7	77.1	65.5	64.5	79.5	1	0.6	2LA-BNS912CLLB
16.9	0.22	72.6	71.7	82.1	70.5	69.5	84.5	1	0.6	2LA-BNS913CLLB
19.5	0.38	79.2	78.3	90.2	75.5	74.5	94.5	1	0.6	2LA-BNS914CLLB
20.1	0.39	84.2	83.3	95.2	80.5	79.5	99.5	1	0.6	2LA-BNS915CLLB
20.8	0.41	89.2	88.3	100.2	85.5	84.5	104.5	1	0.6	2LA-BNS916CLLB
22.8	0.59	96.0	95.0	108.6	92	89.5	113	1	0.6	2LA-BNS917CLLB
23.5	0.62	100.9	100.0	113.6	97	94.5	118	1	0.6	2LA-BNS918CLLB
24.2	0.65	105.9	105.0	118.6	102	99.5	123	1	0.6	2LA-BNS919CLLB
26.2	0.87	111.9	110.9	127.3	107	104.5	133	1	0.6	2LA-BNS920CLLB

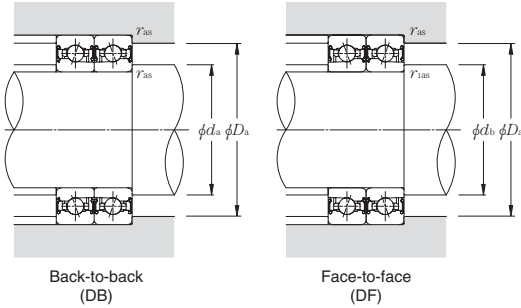
## ULTAGE Sealed high-speed angular contact ball bearings (steel ball type) 2LA-BNS9 LLB series

Contact angle 20°  $d$  50~100mm



Part number	Boundary dimensions						Basic load ratings				Static axial load capacity		Limiting speed min <sup>-1</sup> grease lubrication
	mm						dynamic kN		dynamic kgf		kN	kgf	
	$d$	$D$	$B$	$r_{18 \text{ min}}$ ①	$r_{18 \text{ min}}$ ①		$C_r$	$C_{or}$	$C_r$	$C_{or}$			
2LA-BNS910LLB	50	72	12	0.6	0.3	7.90	7.10	805	725	11.9	1 220	23 100	
2LA-BNS911LLB	55	80	13	1	0.6	10.1	9.00	1 030	915	15.1	1 540	20 800	
2LA-BNS912LLB	60	85	13	1	0.6	10.4	9.70	1 060	990	16.3	1 660	19 400	
2LA-BNS913LLB	65	90	13	1	0.6	10.6	10.4	1 080	1 060	17.5	1 790	18 200	
2LA-BNS914LLB	70	100	16	1	0.6	13.4	13.1	1 360	1 340	22.1	2 250	16 600	
2LA-BNS915LLB	75	105	16	1	0.6	13.7	14.1	1 400	1 430	23.6	2 410	15 600	
2LA-BNS916LLB	80	110	16	1	0.6	14.1	15.0	1 440	1 530	25.2	2 570	14 800	
2LA-BNS917LLB	85	120	18	1.1	0.6	16.9	17.8	1 730	1 820	29.9	3 050	13 700	
2LA-BNS918LLB	90	125	18	1.1	0.6	17.4	19.0	1 770	1 930	32.0	3 250	13 100	
2LA-BNS919LLB	95	130	18	1.1	0.6	17.8	20.1	1 820	2 050	34.0	3 450	12 500	
2LA-BNS920LLB	100	140	20	1.1	0.6	25.1	27.3	2 560	2 780	46.0	4 700	11 700	

① Minimum allowable value for corner radius dimension  $r$  or  $r_1$ .



**Dynamic equivalent radial load**  $P_r = X F_r + Y F_a$

e	Single row / Tandem				Back-to-back / Face-to-face			
	$F_a / F_r \leq e$		$F_a / F_r > e$		$F_a / F_r \leq e$		$F_a / F_r > e$	
	X	Y	X	Y	X	Y	X	Y
0.57	1	0	0.43	1	1	1.09	0.7	1.63

**Static equivalent radial load**  $P_{or} = X_0 F_r + Y_0 F_a$

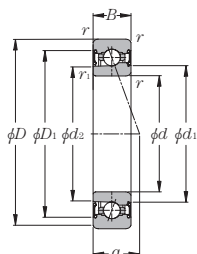
Single row / Tandem		Back-to-back / Face-to-face	
$X_0$	$Y_0$	$X_0$	$Y_0$
0.5	0.42	1	0.84

When  $P_{or} < F_r$  with single-row or tandem arrangement,  $P_{or} = F_r$ .

Load center mm	Mass kg Single-row (approx.)	Reference dimensions mm			Abutment and fillet dimensions mm					Part number
		$d_1$	$d_2$	$D_1$	$d_a$ min	$d_b$ min	$D_a$ max	$r_{as}$ max	$r_{ias}$ max	
17.2	0.14	56.9	56.0	65.0	54.5	52.5	67.5	0.6	0.3	2LA-BNS910LLB
18.9	0.19	62.6	61.7	72.1	60.5	59.5	74.5	1	0.6	2LA-BNS911LLB
19.8	0.21	67.6	66.7	77.1	65.5	64.5	79.5	1	0.6	2LA-BNS912LLB
20.7	0.22	72.6	71.7	82.1	70.5	69.5	84.5	1	0.6	2LA-BNS913LLB
23.6	0.38	79.2	78.3	90.2	75.5	74.5	94.5	1	0.6	2LA-BNS914LLB
24.5	0.39	84.2	83.3	95.2	80.5	79.5	99.5	1	0.6	2LA-BNS915LLB
25.4	0.41	89.2	88.3	100.2	85.5	84.5	104.5	1	0.6	2LA-BNS916LLB
27.8	0.59	96.0	95.0	108.6	92	89.5	113	1	0.6	2LA-BNS917LLB
28.7	0.62	100.9	100.0	113.6	97	94.5	118	1	0.6	2LA-BNS918LLB
29.6	0.65	105.9	105.0	118.6	102	99.5	123	1	0.6	2LA-BNS919LLB
32.0	0.87	111.9	110.9	127.3	107	104.5	133	1	0.6	2LA-BNS920LLB

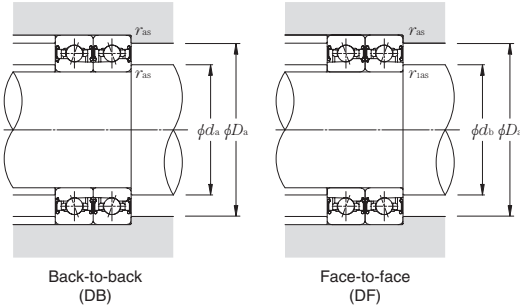
## ULTAGE Sealed high-speed angular contact ball bearings (steel ball type) 2LA-BNS9 LLB series

Contact angle 25°  $d$  50~100mm



Part number	Boundary dimensions mm						Basic load ratings dynamic static dynamic static kN kgf				Static axial load capacity kN kgf		Limiting speed min <sup>-1</sup> grease lubrication
	$d$	$D$	$B$	$r_{18 \text{ min}}$ <sup>①</sup>	$r_{18 \text{ min}}$ <sup>①</sup>	$C_r$	$C_{or}$	$C_r$	$C_{or}$				
2LA-BNS910ADLLB	50	72	12	0.6	0.3	7.60	6.90	775	700	12.4	1 270	20 500	
2LA-BNS911ADLLB	55	80	13	1	0.6	9.75	8.70	990	885	16.8	1 710	18 500	
2LA-BNS912ADLLB	60	85	13	1	0.6	10.0	9.40	1 020	960	18.1	1 850	17 200	
2LA-BNS913ADLLB	65	90	13	1	0.6	10.3	10.1	1 050	1 030	19.5	1 990	16 100	
2LA-BNS914ADLLB	70	100	16	1	0.6	12.9	12.7	1 320	1 300	24.6	2 500	14 700	
2LA-BNS915ADLLB	75	105	16	1	0.6	13.3	13.6	1 350	1 390	26.3	2 680	13 900	
2LA-BNS916ADLLB	80	110	16	1	0.6	13.6	14.5	1 390	1 480	28.0	2 860	13 200	
2LA-BNS917ADLLB	85	120	18	1.1	0.6	16.4	17.2	1 670	1 760	33.5	3 400	12 200	
2LA-BNS918ADLLB	90	125	18	1.1	0.6	16.8	18.4	1 710	1 870	35.5	3 600	11 600	
2LA-BNS919ADLLB	95	130	18	1.1	0.6	17.2	19.5	1 760	1 990	37.5	3 850	11 100	
2LA-BNS920ADLLB	100	140	20	1.1	0.6	24.2	26.4	2 470	2 690	51.0	5 200	10 400	

① Minimum allowable value for corner radius dimension  $r$  or  $r_1$ .



**Dynamic equivalent radial load**  $P_r = X F_r + Y F_a$

e	Single row / Tandem				Back-to-back / Face-to-face			
	$F_a / F_r \leq e$		$F_a / F_r > e$		$F_a / F_r \leq e$		$F_a / F_r > e$	
	X	Y	X	Y	X	Y	X	Y
0.68	1	0	0.41	0.87	1	0.92	0.67	1.41

**Static equivalent radial load**  $P_{or} = X_0 F_r + Y_0 F_a$

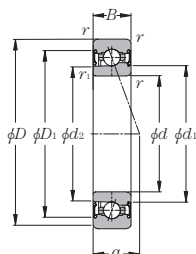
Single row / Tandem		Back-to-back / Face-to-face	
$X_0$	$Y_0$	$X_0$	$Y_0$
0.5	0.38	1	0.76

When  $P_{or} < F_r$  with single-row or tandem arrangement,  $P_{or} = F_r$ .

Load center mm	Mass kg Single-row (approx.)	Reference dimensions mm			Abutment and fillet dimensions mm					Part number
		$d_1$	$d_2$	$D_1$	$d_a$ min	$d_b$ min	$D_a$ max	$r_{as}$ max	$r_{ias}$ max	
20.3	0.14	56.9	56.0	65.0	54.5	52.5	67.5	0.6	0.3	2LA-BNS910ADLLB
22.3	0.19	62.6	61.7	72.1	60.5	59.5	74.5	1	0.6	2LA-BNS911ADLLB
23.5	0.21	67.6	66.7	77.1	65.5	64.5	79.5	1	0.6	2LA-BNS912ADLLB
24.7	0.22	72.6	71.7	82.1	70.5	69.5	84.5	1	0.6	2LA-BNS913ADLLB
27.9	0.38	79.2	78.3	90.2	75.5	74.5	94.5	1	0.6	2LA-BNS914ADLLB
29.1	0.39	84.2	83.3	95.2	80.5	79.5	99.5	1	0.6	2LA-BNS915ADLLB
30.3	0.41	89.2	88.3	100.2	85.5	84.5	104.5	1	0.6	2LA-BNS916ADLLB
33.0	0.59	96.0	95.0	108.6	92	89.5	113	1	0.6	2LA-BNS917ADLLB
34.2	0.62	100.9	100.0	113.6	97	94.5	118	1	0.6	2LA-BNS918ADLLB
35.4	0.65	105.9	105.0	118.6	102	99.5	123	1	0.6	2LA-BNS919ADLLB
38.1	0.87	111.9	110.9	127.3	107	104.5	133	1	0.6	2LA-BNS920ADLLB

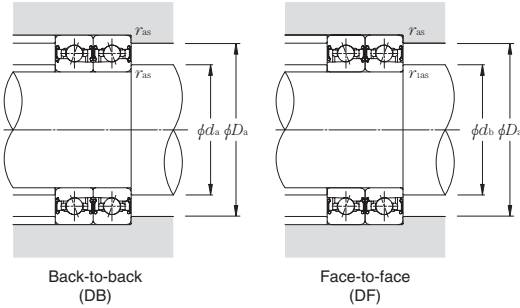
## ULTAGE Sealed high-speed angular contact ball bearings (steel ball type) 2LA-BNS0 LLB series

Contact angle 15°  $d$  45~100mm



Part number	Boundary dimensions mm						Basic load ratings dynamic static dynamic static kN kgf				Static axial load capacity kN kgf		Factor $f_0$	Limiting speed min <sup>-1</sup> grease lubrication
	$d$	$D$	$B$	$r_3$ min <sup>①</sup>	$r_{18}$ min <sup>①</sup>	$C_r$	$C_{or}$	$C_r$	$C_{or}$					
2LA-BNS009CLLB	45	75	16	1	0.6	11.8	9.15	1 210	930	13.4	1 370	10.7	22 200	
2LA-BNS010CLLB	50	80	16	1	0.6	14.7	11.5	1 500	1 170	16.8	1 720	10.7	20 500	
2LA-BNS011CLLB	55	90	18	1.1	0.6	17.3	13.6	1 760	1 380	19.9	2 030	10.6	18 300	
2LA-BNS012CLLB	60	95	18	1.1	0.6	18.1	15.0	1 850	1 530	22.0	2 240	10.7	17 200	
2LA-BNS013CLLB	65	100	18	1.1	0.6	18.4	15.8	1 870	1 610	23.2	2 360	10.8	16 100	
2LA-BNS014CLLB	70	110	20	1.1	0.6	22.4	19.9	2 290	2 030	29.2	2 980	10.8	14 800	
2LA-BNS015CLLB	75	115	20	1.1	0.6	23.9	22.4	2 440	2 290	33.0	3 350	10.9	14 000	
2LA-BNS016CLLB	80	125	22	1.1	0.6	27.4	25.7	2 790	2 620	38.0	3 850	10.9	13 000	
2LA-BNS017CLLB	85	130	22	1.1	0.6	27.7	26.8	2 830	2 740	39.5	4 000	10.9	12 400	
2LA-BNS018CLLB	90	140	24	1.5	1	32.0	31.5	3 300	3 200	46.0	4 700	10.9	11 600	
2LA-BNS019CLLB	95	145	24	1.5	1	32.5	32.5	3 300	3 350	48.0	4 900	11.0	11 100	
2LA-BNS020CLLB	100	150	24	1.5	1	33.5	35.0	3 450	3 600	51.5	5 250	11.0	10 600	

① Minimum allowable value for corner radius dimension  $r$  or  $r_1$ .



Back-to-back  
(DB)

Face-to-face  
(DF)

### Dynamic equivalent radial load

$$P_r = X F_r + Y F_a$$

$i \cdot f_0 \cdot F_a / C_{Or}$	$e$	Single row / Tandem				Back-to-back / Face-to-face			
		$F_d / F_r \leq e$		$F_d / F_r > e$		$F_d / F_r \leq e$		$F_d / F_r > e$	
		X	Y	X	Y	X	Y	X	Y
0.178	0.35					1.57	1.76	2.56	
0.357	0.36					1.53	1.71	2.48	
0.714	0.38					1.46	1.64	2.38	
1.07	0.4					1.42	1.59	2.31	
1.43	0.41	1	0	0.44	1.38	1	1.55	2.25	0.72
2.14	0.43				1.33	1.33	1.49	2.16	
3.57	0.44				1.25	1.25	1.4	2.03	
5.35	0.47				1.18	1.18	1.32	1.92	
7.14	0.49				1.13	1.13	1.26	1.83	

### Static equivalent radial load

$$P_{Or} = X_0 F_r + Y_0 F_a$$

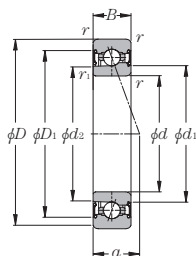
Single row / Tandem		Back-to-back / Face-to-face	
$X_0$	$Y_0$	$X_0$	$Y_0$
0.52	0.54	1.04	1.08

When  $P_{Or} < P_r$  with single-row or tandem arrangement,  $P_{Or} = P_r$ .

Load center mm	Mass kg Single-row (approx.)	Reference dimensions mm			Abutment and fillet dimensions mm					Part number
		$d_1$	$d_2$	$D_1$	$d_a$ min	$d_b$ min	$D_a$ max	$r_{as}$ max	$r_{ias}$ max	
16.1	0.26	54.1	53.3	65.0	50.5	49.5	69.5	1	0.6	2LA-BNS009CLLB
16.8	0.28	58.4	57.5	70.5	55.5	54.5	74.5	1	0.6	2LA-BNS010CLLB
18.8	0.41	65.2	64.1	78.7	62	59.5	83	1	0.6	2LA-BNS011CLLB
19.5	0.44	70.1	69.1	83.5	67	64.5	88	1	0.6	2LA-BNS012CLLB
20.1	0.47	75.2	74.2	88.2	72	69.5	93	1	0.6	2LA-BNS013CLLB
22.2	0.66	81.9	80.8	96.8	77	74.5	103	1	0.6	2LA-BNS014CLLB
22.8	0.69	86.8	85.8	102.2	82	79.5	108	1	0.6	2LA-BNS015CLLB
24.8	0.94	93.7	92.5	110.2	87	84.5	118	1	0.6	2LA-BNS016CLLB
25.5	0.98	98.6	97.5	115.4	92	89.5	123	1	0.6	2LA-BNS017CLLB
27.5	1.29	105.3	104.1	123.2	98.5	95.5	131.5	1.5	1	2LA-BNS018CLLB
28.2	1.34	110.4	109.1	128.1	103.5	100.5	136.5	1.5	1	2LA-BNS019CLLB
28.9	1.40	115.4	114.2	132.7	108.5	105.5	141.5	1.5	1	2LA-BNS020CLLB

## ULTAGE Sealed high-speed angular contact ball bearings (steel ball type) 2LA-BNS0 LLB series

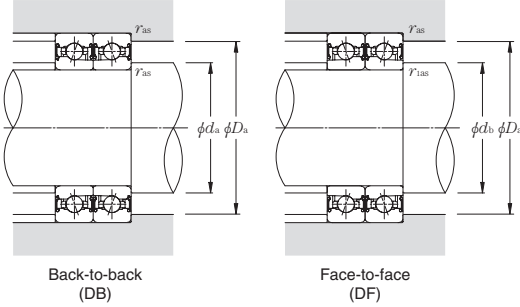
Contact angle 20°  $d$  45~100mm



Part number	Boundary dimensions mm						Basic load ratings dynamic static dynamic static kN kgf				Static axial load capacity kN kgf		Limiting speed min <sup>-1</sup> grease lubrication
	$d$	$D$	$B$	$r_3$ min <sup>①</sup>	$r_{18}$ min <sup>①</sup>	$C_t$	$C_{or}$	$C_t$	$C_{or}$				
2LA-BNS009LLB	45	75	16	1	0.6	11.5	8.95	1 180	910	15.0	1 530	23 500	
2LA-BNS010LLB	50	80	16	1	0.6	14.4	11.2	1 470	1 150	18.8	1 920	21 600	
2LA-BNS011LLB	55	90	18	1.1	0.6	16.8	13.3	1 720	1 350	22.2	2 260	19 400	
2LA-BNS012LLB	60	95	18	1.1	0.6	17.6	14.7	1 800	1 490	24.6	2 500	18 200	
2LA-BNS013LLB	65	100	18	1.1	0.6	17.9	15.4	1 830	1 570	25.9	2 640	17 100	
2LA-BNS014LLB	70	110	20	1.1	0.6	21.9	19.4	2 230	1 980	32.5	3 300	15 600	
2LA-BNS015LLB	75	115	20	1.1	0.6	23.3	21.9	2 380	2 230	36.5	3 750	14 800	
2LA-BNS016LLB	80	125	22	1.1	0.6	26.7	25.1	2 720	2 560	42.0	4 300	13 700	
2LA-BNS017LLB	85	130	22	1.1	0.6	27.0	26.2	2 760	2 670	44.0	4 500	13 100	
2LA-BNS018LLB	90	140	24	1.5	1	31.5	30.5	3 200	3 150	51.5	5 250	12 200	
2LA-BNS019LLB	95	145	24	1.5	1	31.5	32.0	3 250	3 250	53.5	5 450	11 700	
2LA-BNS020LLB	100	150	24	1.5	1	33.0	34.5	3 350	3 500	57.5	5 850	11 300	

① Minimum allowable value for corner radius dimension  $r$  or  $r_1$ .





**Dynamic equivalent radial load**  $P_r = X F_r + Y F_a$

e	Single row / Tandem				Back-to-back / Face-to-face			
	$F_a / F_r \leq e$		$F_a / F_r > e$		$F_a / F_r \leq e$		$F_a / F_r > e$	
	X	Y	X	Y	X	Y	X	Y
0.57	1	0	0.43	1	1	1.09	0.7	1.63

**Static equivalent radial load**  $P_{or} = X_o F_r + Y_o F_a$

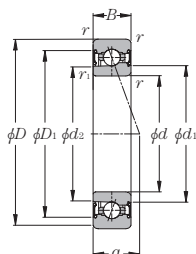
Single row / Tandem		Back-to-back / Face-to-face	
$X_o$	$Y_o$	$X_o$	$Y_o$
0.5	0.42	1	0.84

When  $P_{or} < F_r$  with single-row or tandem arrangement,  $P_{or} = F_r$ .

Load center mm	Mass kg Single-row (approx.)	Reference dimensions mm			Abutment and fillet dimensions mm					Part number
		$d_1$	$d_2$	$D_1$	$d_a$ min	$d_b$ min	$D_a$ max	$r_{as}$ max	$r_{ias}$ max	
19.0	0.26	54.1	53.3	65.0	50.5	49.5	69.5	1	0.6	2LA-BNS009LLB
19.9	0.28	58.4	57.5	70.5	55.5	54.5	74.5	1	0.6	2LA-BNS010LLB
22.3	0.41	65.2	64.2	78.7	62	59.5	83	1	0.6	2LA-BNS011LLB
23.2	0.44	70.1	69.2	83.5	67	64.5	88	1	0.6	2LA-BNS012LLB
24.1	0.47	75.2	74.2	88.2	72	69.5	93	1	0.6	2LA-BNS013LLB
26.5	0.66	81.9	80.8	96.8	77	74.5	103	1	0.6	2LA-BNS014LLB
27.4	0.69	86.8	85.8	102.2	82	79.5	108	1	0.6	2LA-BNS015LLB
29.8	0.94	93.7	92.5	110.2	87	84.5	118	1	0.6	2LA-BNS016LLB
30.7	0.98	98.6	97.5	115.4	92	89.5	123	1	0.6	2LA-BNS017LLB
33.1	1.29	105.3	104.2	123.2	98.5	95.5	131.5	1.5	1	2LA-BNS018LLB
34.0	1.34	110.4	109.2	128.1	103.5	100.5	136.5	1.5	1	2LA-BNS019LLB
34.9	1.40	115.4	114.2	132.7	108.5	105.5	141.5	1.5	1	2LA-BNS020LLB

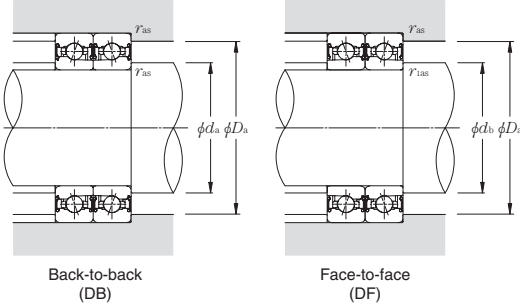
## ULTAGE Sealed high-speed angular contact ball bearings (steel ball type) 2LA-BNS0 LLB series

Contact angle 25°  $d$  45~100mm



Part number	Boundary dimensions						Basic load ratings				Static axial load capacity		Limiting speed min <sup>-1</sup> grease lubrication
	mm						dynamic kN		dynamic kgf		kN	kgf	
	$d$	$D$	$B$	$r_{3 \text{ min}}$ ①	$r_{18 \text{ min}}$ ①	$C_r$	$C_{or}$	$C_r$	$C_{or}$				
2LA-BNS009ADLLB	45	75	16	1	0.6	11.2	8.65	1 140	885	16.7	1 700	20 800	
2LA-BNS010ADLLB	50	80	16	1	0.6	13.9	10.9	1 420	1 110	21.0	2 140	19 200	
2LA-BNS011ADLLB	55	90	18	1.1	0.6	16.3	12.9	1 660	1 310	24.8	2 530	17 200	
2LA-BNS012ADLLB	60	95	18	1.1	0.6	17.1	14.2	1 740	1 450	27.4	2 800	16 100	
2LA-BNS013ADLLB	65	100	18	1.1	0.6	17.3	14.9	1 770	1 520	28.9	2 940	15 200	
2LA-BNS014ADLLB	70	110	20	1.1	0.6	21.2	18.8	2 160	1 920	36.5	3 700	13 900	
2LA-BNS015ADLLB	75	115	20	1.1	0.6	22.5	21.2	2 300	2 160	41.0	4 200	13 200	
2LA-BNS016ADLLB	80	125	22	1.1	0.6	25.8	24.3	2 630	2 480	47.0	4 800	12 200	
2LA-BNS017ADLLB	85	130	22	1.1	0.6	26.1	25.4	2 670	2 590	49.0	5 000	11 600	
2LA-BNS018ADLLB	90	140	24	1.5	1	30.5	29.7	3 100	3 050	57.5	5 850	10 900	
2LA-BNS019ADLLB	95	145	24	1.5	1	30.5	31.0	3 150	3 150	60.0	6 100	10 400	
2LA-BNS020ADLLB	100	150	24	1.5	1	32.0	33.0	3 250	3 400	64.0	6 550	10 000	

① Minimum allowable value for corner radius dimension  $r$  or  $r_1$ .



**Dynamic equivalent radial load**  $P_r = X F_r + Y F_a$

e	Single row / Tandem				Back-to-back / Face-to-face			
	$F_a / F_r \leq e$		$F_a / F_r > e$		$F_a / F_r \leq e$		$F_a / F_r > e$	
	X	Y	X	Y	X	Y	X	Y
0.68	1	0	0.41	0.87	1	0.92	0.67	1.41

**Static equivalent radial load**  $P_{or} = X_0 F_r + Y_0 F_a$

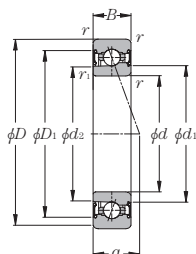
Single row / Tandem		Back-to-back / Face-to-face	
$X_0$	$Y_0$	$X_0$	$Y_0$
0.5	0.38	1	0.76

When  $P_{or} < F_r$  with single-row or tandem arrangement,  $P_{or} = F_r$ .

Load center mm	Mass kg Single-row (approx.)	Reference dimensions mm			Abutment and fillet dimensions mm					Part number
		$d_1$	$d_2$	$D_1$	$d_a$ min	$d_b$ min	$D_a$ max	$r_{as}$ max	$r_{ias}$ max	
22.1	0.26	54.1	53.3	65.0	50.5	49.5	69.5	1	0.6	2LA-BNS009ADLLB
23.3	0.28	58.4	57.6	70.5	55.5	54.5	74.5	1	0.6	2LA-BNS010ADLLB
26.0	0.41	65.2	64.2	78.7	62	59.5	83	1	0.6	2LA-BNS011ADLLB
27.2	0.44	70.1	69.2	83.5	67	64.5	88	1	0.6	2LA-BNS012ADLLB
28.4	0.47	75.2	74.2	88.2	72	69.5	93	1	0.6	2LA-BNS013ADLLB
31.1	0.66	81.9	80.9	96.8	77	74.5	103	1	0.6	2LA-BNS014ADLLB
32.3	0.69	86.8	85.9	102.2	82	79.5	108	1	0.6	2LA-BNS015ADLLB
35.1	0.94	93.7	92.6	110.2	87	84.5	118	1	0.6	2LA-BNS016ADLLB
36.2	0.98	98.6	97.6	115.4	92	89.5	123	1	0.6	2LA-BNS017ADLLB
39.0	1.29	105.3	104.2	123.2	98.5	95.5	131.5	1.5	1	2LA-BNS018ADLLB
40.2	1.34	110.4	109.2	128.1	103.5	100.5	136.5	1.5	1	2LA-BNS019ADLLB
41.3	1.40	115.4	114.2	132.7	108.5	105.5	141.5	1.5	1	2LA-BNS020ADLLB

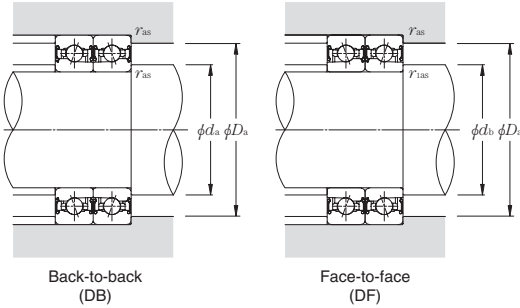
## ULTAGE Sealed high-speed angular contact ball bearings (ceramic ball type) 5S-2LA-BNS9 LLB series

Contact angle 15°  $d$  50~100mm



Part number	Boundary dimensions						Basic load ratings				Static axial load capacity		Factor $f_0$	Limiting speed min <sup>-1</sup> grease lubrication
	mm						dynamic kN		static kgf		kN	kgf		
	$d$	$D$	$B$	$r_{3 \text{ min}}$ <sup>①</sup>	$r_{18 \text{ min}}$ <sup>①</sup>	$C_r$	$C_{or}$	$C_r$	$C_{or}$					
5S-2LA-BNS910CLLB	50	72	12	0.6	0.3	8.10	5.05	825	515	6.80	690	7.7	25 600	
5S-2LA-BNS911CLLB	55	80	13	1	0.6	10.3	6.40	1 050	650	8.55	870	7.6	23 100	
5S-2LA-BNS912CLLB	60	85	13	1	0.6	10.6	6.90	1 080	705	9.25	945	7.7	21 500	
5S-2LA-BNS913CLLB	65	90	13	1	0.6	10.9	7.40	1 110	755	9.95	1 010	7.8	20 100	
5S-2LA-BNS914CLLB	70	100	16	1	0.6	13.7	9.35	1 400	950	12.5	1 280	7.7	18 300	
5S-2LA-BNS915CLLB	75	105	16	1	0.6	14.1	10.0	1 440	1 020	13.4	1 370	7.8	17 300	
5S-2LA-BNS916CLLB	80	110	16	1	0.6	14.5	10.6	1 480	1 090	14.3	1 460	7.8	16 400	
5S-2LA-BNS917CLLB	85	120	18	1.1	0.6	17.4	12.7	1 770	1 290	17.0	1 730	7.8	15 200	
5S-2LA-BNS918CLLB	90	125	18	1.1	0.6	17.9	13.5	1 820	1 370	18.1	1 850	7.8	14 500	
5S-2LA-BNS919CLLB	95	130	18	1.1	0.6	18.3	14.3	1 870	1 460	19.2	1 960	7.8	13 900	
5S-2LA-BNS920CLLB	100	140	20	1.1	0.6	25.7	19.4	2 620	1 980	26.0	2 650	7.7	13 000	

① Minimum allowable value for corner radius dimension  $r$  or  $r_1$ .



### Dynamic equivalent radial load

$$P_r = X F_r + Y F_a$$

$\frac{i \cdot f_0 \cdot F_a}{C_{Or}}$	$e$	Single row / Tandem				Back-to-back / Face-to-face			
		$F_d F_r \leq e$		$F_d F_r > e$		$F_d F_r \leq e$		$F_d F_r > e$	
		X	Y	X	Y	X	Y	X	Y
0.178	0.35					1.57		1.76	2.56
0.357	0.36					1.53		1.71	2.48
0.714	0.38					1.46		1.64	2.38
1.07	0.4					1.42		1.59	2.31
1.43	0.41	1	0	0.44	1.38	1	1.55	0.72	2.25
2.14	0.43				1.33		1.49		2.16
3.57	0.44				1.25		1.4		2.03
5.35	0.47				1.18		1.32		1.92
7.14	0.49				1.13		1.26		1.83

### Static equivalent radial load

$$P_{Or} = X_0 F_r + Y_0 F_a$$

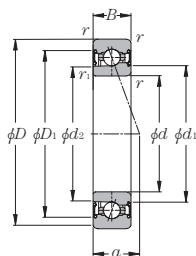
Single row / Tandem		Back-to-back / Face-to-face	
$X_0$	$Y_0$	$X_0$	$Y_0$
0.52	0.54	1.04	1.08

When  $P_{Or} < F_r$  with single-row or tandem arrangement,  $P_{Or} = F_r$ .

Load center mm	Mass kg Single-row (approx.)	Reference dimensions mm			Abutment and fillet dimensions mm					Part number
		$d_1$	$d_2$	$D_1$	$d_a$ min	$d_b$ min	$D_a$ max	$r_{as}$ max	$r_{ias}$ max	
14.2	0.14	56.9	56.0	65.0	54.5	52.5	67.5	0.6	0.3	5S-2LA-BNS910CLLB
15.6	0.18	62.6	61.7	72.1	60.5	59.5	74.5	1	0.6	5S-2LA-BNS911CLLB
16.3	0.20	67.6	66.7	77.1	65.5	64.5	79.5	1	0.6	5S-2LA-BNS912CLLB
16.9	0.21	72.6	71.7	82.1	70.5	69.5	84.5	1	0.6	5S-2LA-BNS913CLLB
19.5	0.36	79.2	78.3	90.2	75.5	74.5	94.5	1	0.6	5S-2LA-BNS914CLLB
20.1	0.37	84.2	83.3	95.2	80.5	79.5	99.5	1	0.6	5S-2LA-BNS915CLLB
20.8	0.39	89.2	88.3	100.2	85.5	84.5	104.5	1	0.6	5S-2LA-BNS916CLLB
22.8	0.57	96.0	95.0	108.6	92	89.5	113	1	0.6	5S-2LA-BNS917CLLB
23.5	0.59	100.9	100.0	113.6	97	94.5	118	1	0.6	5S-2LA-BNS918CLLB
24.2	0.62	105.9	105.0	118.6	102	99.5	123	1	0.6	5S-2LA-BNS919CLLB
26.2	0.82	111.9	110.9	127.3	107	104.5	133	1	0.6	5S-2LA-BNS920CLLB

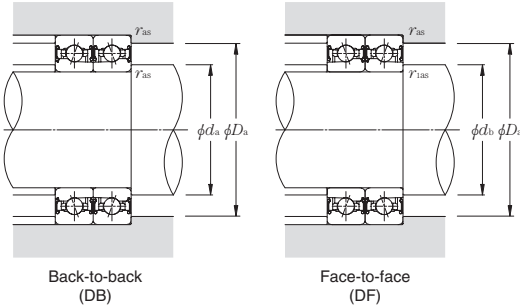
## ULTAGE Sealed high-speed angular contact ball bearings (ceramic ball type) 5S-2LA-BNS9 LLB series

Contact angle 20°  $d$  50~100mm



Part number	Boundary dimensions						Basic load ratings				Static axial load capacity		Limiting speed min <sup>-1</sup> grease lubrication
	mm						dynamic	static	dynamic	static	kN	kgf	
	$d$	$D$	$B$	$r_{18 \text{ min}}^{\text{①}}$	$r_{18 \text{ min}}^{\text{①}}$		kN		kgf				
						$C_r$	$C_{or}$	$C_r$	$C_{or}$				
5S-2LA-BNS910LLB	50	72	12	0.6	0.3	7.90	4.95	805	505	7.75	790	28 200	
5S-2LA-BNS911LLB	55	80	13	1	0.6	10.1	6.25	1 030	635	9.75	995	25 500	
5S-2LA-BNS912LLB	60	85	13	1	0.6	10.4	6.70	1 060	685	10.5	1 080	23 700	
5S-2LA-BNS913LLB	65	90	13	1	0.6	10.6	7.20	1 080	735	11.3	1 160	22 200	
5S-2LA-BNS914LLB	70	100	16	1	0.6	13.4	9.10	1 360	930	14.3	1 460	20 200	
5S-2LA-BNS915LLB	75	105	16	1	0.6	13.7	9.75	1 400	995	15.3	1 560	19 100	
5S-2LA-BNS916LLB	80	110	16	1	0.6	14.1	10.4	1 440	1 060	16.3	1 660	18 100	
5S-2LA-BNS917LLB	85	120	18	1.1	0.6	16.9	12.3	1 730	1 260	19.4	1 980	16 800	
5S-2LA-BNS918LLB	90	125	18	1.1	0.6	17.4	13.1	1 770	1 340	20.6	2 100	16 000	
5S-2LA-BNS919LLB	95	130	18	1.1	0.6	17.8	14.0	1 820	1 420	21.9	2 230	15 300	
5S-2LA-BNS920LLB	100	140	20	1.1	0.6	25.1	18.9	2 560	1 930	29.7	3 050	14 300	

① Minimum allowable value for corner radius dimension  $r$  or  $r_1$ .



**Dynamic equivalent radial load**  $P_r = X F_r + Y F_a$

e	Single row / Tandem				Back-to-back / Face-to-face			
	$F_a / F_r \leq e$		$F_a / F_r > e$		$F_a / F_r \leq e$		$F_a / F_r > e$	
	X	Y	X	Y	X	Y	X	Y
0.57	1	0	0.43	1	1	1.09	0.7	1.63

**Static equivalent radial load**  $P_{or} = X_0 F_r + Y_0 F_a$

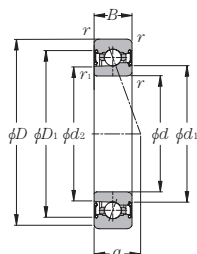
Single row / Tandem		Back-to-back / Face-to-face	
$X_0$	$Y_0$	$X_0$	$Y_0$
0.5	0.42	1	0.84

When  $P_{or} < F_r$  with single-row or tandem arrangement,  $P_{or} = F_r$ .

Load center mm	Mass kg Single-row (approx.)	Reference dimensions mm			Abutment and fillet dimensions mm					Part number
		$d_1$	$d_2$	$D_1$	$d_a$ min	$d_b$ min	$D_a$ max	$r_{as}$ max	$r_{ias}$ max	
17.2	0.14	56.9	56.0	65.0	54.5	52.5	67.5	0.6	0.3	5S-2LA-BNS910LLB
18.9	0.18	62.6	61.7	72.1	60.5	59.5	74.5	1	0.6	5S-2LA-BNS911LLB
19.8	0.20	67.6	66.7	77.1	65.5	64.5	79.5	1	0.6	5S-2LA-BNS912LLB
20.7	0.21	72.6	71.7	82.1	70.5	69.5	84.5	1	0.6	5S-2LA-BNS913LLB
23.6	0.36	79.2	78.3	90.2	75.5	74.5	94.5	1	0.6	5S-2LA-BNS914LLB
24.5	0.37	84.2	83.3	95.2	80.5	79.5	99.5	1	0.6	5S-2LA-BNS915LLB
25.4	0.39	89.2	88.3	100.2	85.5	84.5	104.5	1	0.6	5S-2LA-BNS916LLB
27.8	0.57	96.0	95.0	108.6	92	89.5	113	1	0.6	5S-2LA-BNS917LLB
28.7	0.59	100.9	100.0	113.6	97	94.5	118	1	0.6	5S-2LA-BNS918LLB
29.6	0.62	105.9	105.0	118.6	102	99.5	123	1	0.6	5S-2LA-BNS919LLB
32.0	0.82	111.9	110.9	127.3	107	104.5	133	1	0.6	5S-2LA-BNS920LLB

## ULTAGE Sealed high-speed angular contact ball bearings (ceramic ball type) 5S-2LA-BNS9 LLB series

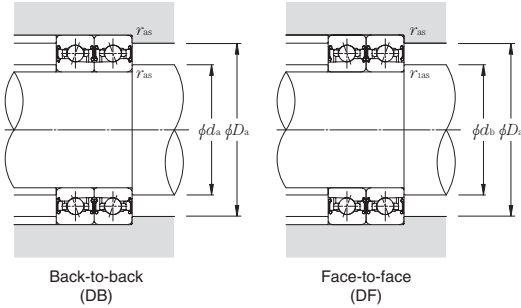
Contact angle 25°  $d$  50~100mm



Part number	Boundary dimensions						Basic load ratings				Static axial load capacity		Limiting speed min <sup>-1</sup> grease lubrication
	mm						dynamic kN		dynamic kgf		kN	kgf	
	$d$	$D$	$B$	$r_{18 \text{ min}}$ <sup>①</sup>	$r_{18 \text{ min}}$ <sup>①</sup>		$C_r$	$C_{or}$	$C_r$	$C_{or}$			
5S-2LA-BNS910ADLLB	50	72	12	0.6	0.3	7.60	4.75	775	485	8.80	895	25 600	
5S-2LA-BNS911ADLLB	55	80	13	1	0.6	9.75	6.05	990	615	11.1	1 130	23 200	
5S-2LA-BNS912ADLLB	60	85	13	1	0.6	10.0	6.50	1 020	665	12.0	1 220	21 600	
5S-2LA-BNS913ADLLB	65	90	13	1	0.6	10.3	7.00	1 050	715	12.9	1 310	20 200	
5S-2LA-BNS914ADLLB	70	100	16	1	0.6	12.9	8.80	1 320	900	16.2	1 650	18 400	
5S-2LA-BNS915ADLLB	75	105	16	1	0.6	13.3	9.45	1 350	960	17.3	1 770	17 400	
5S-2LA-BNS916ADLLB	80	110	16	1	0.6	13.6	10.0	1 390	1 020	18.5	1 890	16 500	
5S-2LA-BNS917ADLLB	85	120	18	1.1	0.6	16.4	11.9	1 670	1 220	22.0	2 240	15 300	
5S-2LA-BNS918ADLLB	90	125	18	1.1	0.6	16.8	12.7	1 710	1 300	23.4	2 390	14 500	
5S-2LA-BNS919ADLLB	95	130	18	1.1	0.6	17.2	13.5	1 760	1 380	24.8	2 530	13 900	
5S-2LA-BNS920ADLLB	100	140	20	1.1	0.6	24.2	18.3	2 470	1 870	33.5	3 450	13 000	

① Minimum allowable value for corner radius dimension  $r$  or  $r_1$ .





**Dynamic equivalent radial load**  $P_r = X F_r + Y F_a$

e	Single row / Tandem				Back-to-back / Face-to-face			
	$F_a / F_r \leq e$		$F_a / F_r > e$		$F_a / F_r \leq e$		$F_a / F_r > e$	
	X	Y	X	Y	X	Y	X	Y
0.68	1	0	0.41	0.87	1	0.92	0.67	1.41

**Static equivalent radial load**  $P_{or} = X_0 F_r + Y_0 F_a$

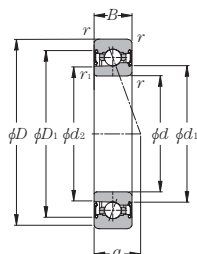
Single row / Tandem		Back-to-back / Face-to-face	
$X_0$	$Y_0$	$X_0$	$Y_0$
0.5	0.38	1	0.76

When  $P_{or} < F_r$  with single-row or tandem arrangement,  $P_{or} = F_r$ .

Load center mm	Mass kg Single-row (approx.)	Reference dimensions mm			Abutment and fillet dimensions mm					Part number
		$d_1$	$d_2$	$D_1$	$d_a$ min	$d_b$ min	$D_a$ max	$r_{as}$ max	$r_{is}$ max	
20.3	0.14	56.9	56.0	65.0	54.5	52.5	67.5	0.6	0.3	5S-2LA-BNS910ADLLB
22.3	0.18	62.6	61.7	72.1	60.5	59.5	74.5	1	0.6	5S-2LA-BNS911ADLLB
23.5	0.20	67.6	66.7	77.1	65.5	64.5	79.5	1	0.6	5S-2LA-BNS912ADLLB
24.7	0.21	72.6	71.7	82.1	70.5	69.5	84.5	1	0.6	5S-2LA-BNS913ADLLB
27.9	0.36	79.2	78.3	90.2	75.5	74.5	94.5	1	0.6	5S-2LA-BNS914ADLLB
29.1	0.37	84.2	83.3	95.2	80.5	79.5	99.5	1	0.6	5S-2LA-BNS915ADLLB
30.3	0.39	89.2	88.3	100.2	85.5	84.5	104.5	1	0.6	5S-2LA-BNS916ADLLB
33.0	0.57	96.0	95.0	108.6	92	89.5	113	1	0.6	5S-2LA-BNS917ADLLB
34.2	0.59	100.9	100.0	113.6	97	94.5	118	1	0.6	5S-2LA-BNS918ADLLB
35.4	0.62	105.9	105.0	118.6	102	99.5	123	1	0.6	5S-2LA-BNS919ADLLB
38.1	0.82	111.9	110.9	127.3	107	104.5	133	1	0.6	5S-2LA-BNS920ADLLB

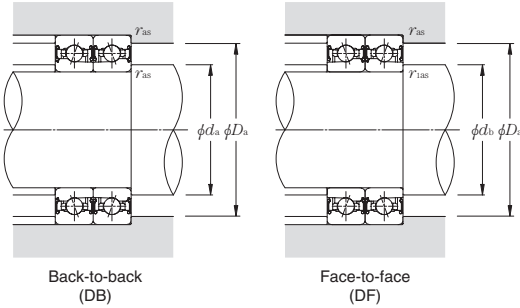
## ULTAGE Sealed high-speed angular contact ball bearings (ceramic ball type) 5S-2LA-BNS0 LLB series

Contact angle 15°  $d$  45~100mm



Part number	Boundary dimensions						Basic load ratings				Static axial load capacity		Factor	Limiting speed min <sup>-1</sup> grease lubrication
	mm						dynamic kN		static kgf		kN	kgf		
	$d$	$D$	$B$	$r_{3 \text{ min}}$ <sup>①</sup>	$r_{18 \text{ min}}$ <sup>①</sup>	$C_r$	$C_{or}$	$C_r$	$C_{or}$					
5S-2LA-BNS009CLLB	45	75	16	1	0.6	11.8	6.20	1 210	645	8.45	860	7.4	26 000	
5S-2LA-BNS010CLLB	50	80	16	1	0.6	14.7	7.50	1 500	815	10.6	1 080	7.4	24 000	
5S-2LA-BNS011CLLB	55	90	18	1.1	0.6	17.3	9.40	1 760	960	12.5	1 280	7.4	21 500	
5S-2LA-BNS012CLLB	60	95	18	1.1	0.6	18.1	10.4	1 850	1 060	13.9	1 420	7.4	20 100	
5S-2LA-BNS013CLLB	65	100	18	1.1	0.6	18.4	10.9	1 870	1 120	14.6	1 490	7.5	18 900	
5S-2LA-BNS014CLLB	70	110	20	1.1	0.6	22.4	13.8	2 290	1 410	18.4	1 880	7.5	17 300	
5S-2LA-BNS015CLLB	75	115	20	1.1	0.6	23.9	15.5	2 440	1 590	20.8	2 120	7.5	16 400	
5S-2LA-BNS016CLLB	80	125	22	1.1	0.6	27.4	17.8	2 790	1 820	23.8	2 430	7.5	15 200	
5S-2LA-BNS017CLLB	85	130	22	1.1	0.6	27.7	18.6	2 830	1 900	24.9	2 540	7.6	14 500	
5S-2LA-BNS018CLLB	90	140	24	1.5	1	32.0	21.8	3 300	2 220	29.2	2 970	7.6	13 600	
5S-2LA-BNS019CLLB	95	145	24	1.5	1	32.5	22.7	3 300	2 310	30.5	3 100	7.6	13 000	
5S-2LA-BNS020CLLB	100	150	24	1.5	1	33.5	24.4	3 450	2 480	32.5	3 350	7.6	12 500	

① Minimum allowable value for corner radius dimension  $r$  or  $r_1$ .



### Dynamic equivalent radial load

$$P_r = X F_r + Y F_a$$

$\frac{i \cdot f_0 \cdot F_a}{C_{Or}}$	e	Single row / Tandem				Back-to-back / Face-to-face			
		$F_d F_r \leq e$		$F_d F_r > e$		$F_d F_r \leq e$		$F_d F_r > e$	
		X	Y	X	Y	X	Y	X	Y
0.178	0.35					1.57	1.76		2.56
0.357	0.36					1.53	1.71		2.48
0.714	0.38					1.46	1.64		2.38
1.07	0.4					1.42	1.59		2.31
1.43	0.41	1	0	0.44	1.38	1	1.55	0.72	2.25
2.14	0.43				1.33	1.49			2.16
3.57	0.44				1.25	1.4			2.03
5.35	0.47				1.18	1.32			1.92
7.14	0.49				1.13	1.26			1.83

### Static equivalent radial load

$$P_{Or} = X_0 F_r + Y_0 F_a$$

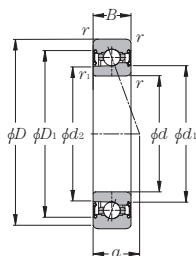
Single row / Tandem		Back-to-back / Face-to-face	
$X_0$	$Y_0$	$X_0$	$Y_0$
0.52	0.54	1.04	1.08

When  $P_{Or} < P_r$  with single-row or tandem arrangement,  $P_{Or} = P_r$ .

Load center mm	Mass kg Single-row (approx.)	Reference dimensions mm			Abutment and fillet dimensions mm					Part number
		$d_1$	$d_2$	$D_1$	$d_a$ min	$d_b$ min	$D_a$ max	$r_{as}$ max	$r_{ias}$ max	
16.1	0.25	54.1	53.3	65.0	50.5	49.5	69.5	1	0.6	5S-2LA-BNS009CLLB
16.8	0.26	58.4	57.5	70.5	55.5	54.5	74.5	1	0.6	5S-2LA-BNS010CLLB
18.8	0.38	65.2	64.1	78.7	62	59.5	83	1	0.6	5S-2LA-BNS011CLLB
19.5	0.41	70.1	69.1	83.5	67	64.5	88	1	0.6	5S-2LA-BNS012CLLB
20.1	0.44	75.2	74.2	88.2	72	69.5	93	1	0.6	5S-2LA-BNS013CLLB
22.2	0.62	81.9	80.8	96.8	77	74.5	103	1	0.6	5S-2LA-BNS014CLLB
22.8	0.65	86.8	85.8	102.2	82	79.5	108	1	0.6	5S-2LA-BNS015CLLB
24.8	0.88	93.7	92.5	110.2	87	84.5	118	1	0.6	5S-2LA-BNS016CLLB
25.5	0.93	98.6	97.5	115.4	92	89.5	123	1	0.6	5S-2LA-BNS017CLLB
27.5	1.22	105.3	104.1	123.2	98.5	95.5	131.5	1.5	1	5S-2LA-BNS018CLLB
28.2	1.27	110.4	109.1	128.1	103.5	100.5	136.5	1.5	1	5S-2LA-BNS019CLLB
28.9	1.32	115.4	114.2	132.7	108.5	105.5	141.5	1.5	1	5S-2LA-BNS020CLLB

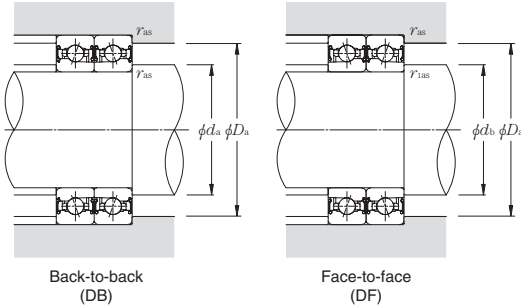
## ULTAGE Sealed high-speed angular contact ball bearings (ceramic ball type) 5S-2LA-BNS0 LLB series

Contact angle 20°  $d$  45~100mm



Part number	Boundary dimensions						Basic load ratings				Static axial load capacity		Limiting speed min <sup>-1</sup> grease lubrication
	mm						dynamic kN		static kgf		kN	kgf	
	$d$	$D$	$B$	$r_3$ min <sup>①</sup>	$r_{18}$ min <sup>①</sup>	$C_r$	$C_{or}$	$C_r$	$C_{or}$				
5S-2LA-BNS009LLB	45	75	16	1	0.6	11.5	6.2	1 180	630	9.70	985	28 700	
5S-2LA-BNS010LLB	50	80	16	1	0.6	14.4	7.8	1 470	795	12.2	1 240	26 500	
5S-2LA-BNS011LLB	55	90	18	1.1	0.6	16.8	9.2	1 720	935	14.4	1 460	23 700	
5S-2LA-BNS012LLB	60	95	18	1.1	0.6	17.6	10.2	1 800	1 040	15.9	1 620	22 200	
5S-2LA-BNS013LLB	65	100	18	1.1	0.6	17.9	10.7	1 830	1 090	16.7	1 710	20 800	
5S-2LA-BNS014LLB	70	110	20	1.1	0.6	21.9	13.5	2 230	1 370	21.1	2 150	19 100	
5S-2LA-BNS015LLB	75	115	20	1.1	0.6	23.3	15.2	2 380	1 550	23.8	2 420	18 100	
5S-2LA-BNS016LLB	80	125	22	1.1	0.6	26.7	17.4	2 720	1 770	27.2	2 780	16 800	
5S-2LA-BNS017LLB	85	130	22	1.1	0.6	27.0	18.1	2 760	1 850	28.4	2 900	16 000	
5S-2LA-BNS018LLB	90	140	24	1.5	1	31.5	21.3	3 200	2 170	33.5	3 400	15 000	
5S-2LA-BNS019LLB	95	145	24	1.5	1	31.5	22.1	3 250	2 260	34.5	3 550	14 300	
5S-2LA-BNS020LLB	100	150	24	1.5	1	33.0	23.8	3 350	2 420	37.5	3 800	13 800	

① Minimum allowable value for corner radius dimension  $r$  or  $r_1$ .



**Dynamic equivalent radial load**  $P_r = X F_r + Y F_a$

e	Single row / Tandem				Back-to-back / Face-to-face			
	$F_a / F_r \leq e$		$F_a / F_r > e$		$F_a / F_r \leq e$		$F_a / F_r > e$	
	X	Y	X	Y	X	Y	X	Y
0.57	1	0	0.43	1	1	1.09	0.7	1.63

**Static equivalent radial load**  $P_{or} = X_0 F_r + Y_0 F_a$

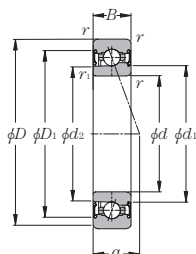
Single row / Tandem		Back-to-back / Face-to-face	
$X_0$	$Y_0$	$X_0$	$Y_0$
0.5	0.42	1	0.84

When  $P_{or} < F_r$  with single-row or tandem arrangement,  $P_{or} = F_r$ .

Load center mm	Mass kg Single-row (approx.)	Reference dimensions mm			Abutment and fillet dimensions mm					Part number
		$d_1$	$d_2$	$D_1$	$d_a$ min	$d_b$ min	$D_a$ max	$r_{as}$ max	$r_{ias}$ max	
19.0	0.25	54.1	53.3	65.0	50.5	49.5	69.5	1	0.6	5S-2LA-BNS009LLB
19.9	0.26	58.4	57.5	70.5	55.5	54.5	74.5	1	0.6	5S-2LA-BNS010LLB
22.3	0.38	65.2	64.2	78.7	62	59.5	83	1	0.6	5S-2LA-BNS011LLB
23.2	0.41	70.1	69.2	83.5	67	64.5	88	1	0.6	5S-2LA-BNS012LLB
24.1	0.44	75.2	74.2	88.2	72	69.5	93	1	0.6	5S-2LA-BNS013LLB
26.5	0.62	81.9	80.8	96.8	77	74.5	103	1	0.6	5S-2LA-BNS014LLB
27.4	0.65	86.8	85.8	102.2	82	79.5	108	1	0.6	5S-2LA-BNS015LLB
29.8	0.88	93.7	92.5	110.2	87	84.5	118	1	0.6	5S-2LA-BNS016LLB
30.7	0.93	98.6	97.5	115.4	92	89.5	123	1	0.6	5S-2LA-BNS017LLB
33.1	1.22	105.3	104.2	123.2	98.5	95.5	131.5	1.5	1	5S-2LA-BNS018LLB
34.0	1.27	110.4	109.2	128.1	103.5	100.5	136.5	1.5	1	5S-2LA-BNS019LLB
34.9	1.32	115.4	114.2	132.7	108.5	105.5	141.5	1.5	1	5S-2LA-BNS020LLB

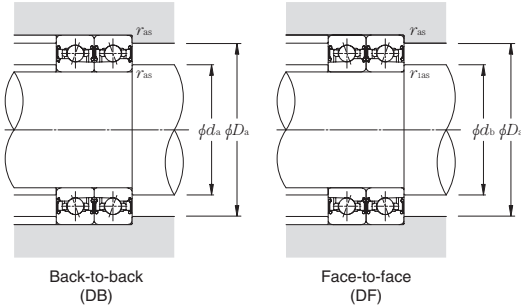
## ULTAGE Sealed high-speed angular contact ball bearings (ceramic ball type) 5S-2LA-BNS0 LLB series

Contact angle 25°  $d$  45~100mm



Part number	Boundary dimensions					Basic load ratings				Static axial load capacity		Limiting speed min <sup>-1</sup> grease lubrication
	mm					dynamic	static	dynamic	static	kN	kgf	
	$d$	$D$	$B$	$r_{3 \text{ min}}$ ①	$r_{18 \text{ min}}$ ①	$C_r$	$C_{or}$	$C_r$	$C_{or}$			
5S-2LA-BNS009ADLLB	45	75	16	1	0.6	11.2	6.00	1 140	610	11.0	1 120	26 100
5S-2LA-BNS010ADLLB	50	80	16	1	0.6	13.9	7.55	1 420	770	13.9	1 410	24 100
5S-2LA-BNS011ADLLB	55	90	18	1.1	0.6	16.3	8.90	1 660	910	16.4	1 670	21 600
5S-2LA-BNS012ADLLB	60	95	18	1.1	0.6	17.1	9.85	1 740	1 000	18.1	1 840	20 200
5S-2LA-BNS013ADLLB	65	100	18	1.1	0.6	17.3	10.4	1 770	1 060	19.0	1 940	19 000
5S-2LA-BNS014ADLLB	70	110	20	1.1	0.6	21.2	13.0	2 160	1 330	24.0	2 440	17 400
5S-2LA-BNS015ADLLB	75	115	20	1.1	0.6	22.5	14.7	2 300	1 500	27.0	2 760	16 500
5S-2LA-BNS016ADLLB	80	125	22	1.1	0.6	25.8	16.9	2 630	1 720	31.0	3 150	15 300
5S-2LA-BNS017ADLLB	85	130	22	1.1	0.6	26.1	17.6	2 670	1 790	32.5	3 300	14 500
5S-2LA-BNS018ADLLB	90	140	24	1.5	1	30.5	20.6	3 100	2 100	38.0	3 850	13 600
5S-2LA-BNS019ADLLB	95	145	24	1.5	1	30.5	21.4	3 150	2 190	39.5	4 000	13 000
5S-2LA-BNS020ADLLB	100	150	24	1.5	1	32.0	23.0	3 250	2 350	42.5	4 300	12 500

① Minimum allowable value for corner radius dimension  $r$  or  $r_1$ .



**Dynamic equivalent radial load**  $P_r = X F_r + Y F_a$

e	Single row / Tandem				Back-to-back / Face-to-face			
	$F_a / F_r \leq e$		$F_a / F_r > e$		$F_a / F_r \leq e$		$F_a / F_r > e$	
	X	Y	X	Y	X	Y	X	Y
0.68	1	0	0.41	0.87	1	0.92	0.67	1.41

**Static equivalent radial load**  $P_{or} = X_0 F_r + Y_0 F_a$

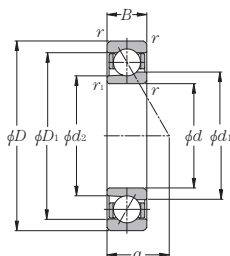
Single row / Tandem		Back-to-back / Face-to-face	
$X_0$	$Y_0$	$X_0$	$Y_0$
0.5	0.38	1	0.76

When  $P_{or} < F_r$  with single-row or tandem arrangement,  $P_{or} = F_r$ .

Load center mm	Mass kg Single-row (approx.)	Reference dimensions mm			Abutment and fillet dimensions mm					Part number
		$d_1$	$d_2$	$D_1$	$d_a$ min	$d_b$ min	$D_a$ max	$r_{as}$ max	$r_{ias}$ max	
22.1	0.25	54.1	53.3	65	50.5	49.5	69.5	1	0.6	5S-2LA-BNS009ADLLB
23.3	0.26	58.4	57.6	70.5	55.5	54.5	74.5	1	0.6	5S-2LA-BNS010ADLLB
26.0	0.38	65.2	64.2	78.7	62	59.5	83	1	0.6	5S-2LA-BNS011ADLLB
27.2	0.41	70.1	69.2	83.5	67	64.5	88	1	0.6	5S-2LA-BNS012ADLLB
28.4	0.44	75.2	74.2	88.2	72	69.5	93	1	0.6	5S-2LA-BNS013ADLLB
31.1	0.62	81.9	80.9	96.8	77	74.5	103	1	0.6	5S-2LA-BNS014ADLLB
32.3	0.65	86.8	85.9	102.2	82	79.5	108	1	0.6	5S-2LA-BNS015ADLLB
35.1	0.88	93.7	92.6	110.2	87	84.5	118	1	0.6	5S-2LA-BNS016ADLLB
36.2	0.93	98.6	97.6	115.4	92	89.5	123	1	0.6	5S-2LA-BNS017ADLLB
39.0	1.22	105.3	104.2	123.2	98.5	95.5	131.5	1.5	1	5S-2LA-BNS018ADLLB
40.2	1.27	110.4	109.2	128.1	103.5	100.5	136.5	1.5	1	5S-2LA-BNS019ADLLB
41.3	1.32	115.4	114.2	132.7	108.5	105.5	141.5	1.5	1	5S-2LA-BNS020ADLLB

## Angular contact ball bearings for motors and lathes (steel ball type) BNT9 series

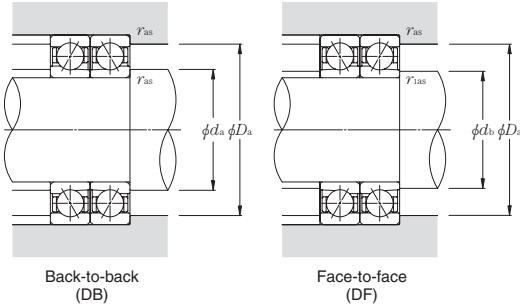
Contact angle 15°  $d$  10~65mm



Part number	Boundary dimensions					Basic load ratings				Static axial load capacity		Factor	Limiting speed		
	mm					dynamic	static	dynamic	static	kN	kgf		$f_0$	grease lubrication	oil lubrication
	$d$	$D$	$B$	$r_3$ min <sup>①</sup>	$r_3$ max <sup>①</sup>	$C_r$	$C_{or}$	$C_r$	$C_{or}$					min <sup>-1</sup>	
BNT900	10	22	6	0.3	0.15	2.30	1.00	235	101	1.43	146	9.3	62 200	125 600	
BNT901	12	24	6	0.3	0.15	2.57	1.22	262	124	1.76	180	9.6	55 300	111 700	
BNT902	15	28	7	0.3	0.15	3.70	1.75	375	179	2.54	259	9.5	46 300	93 500	
BNT903	17	30	7	0.3	0.15	3.90	1.95	395	199	2.82	288	9.7	42 300	85 500	
BNT904	20	37	9	0.3	0.15	5.60	2.99	570	305	4.35	440	9.7	34 900	70 500	
BNT905	25	42	9	0.3	0.15	6.00	3.55	610	360	5.15	525	10.1	29 700	60 000	
BNT906	30	47	9	0.3	0.15	6.35	4.10	650	420	6.00	610	10.4	25 800	52 200	
BNT907	35	55	10	0.6	0.3	10.1	6.30	1 030	645	9.20	940	10.1	21 000	42 400	
BNT908	40	62	12	0.6	0.3	10.7	7.30	1 090	740	10.6	1 080	10.4	18 500	37 500	
BNT909	45	68	12	0.6	0.3	13.2	9.20	1 350	935	13.4	1 370	10.4	16 700	33 800	
BNT910	50	72	12	0.6	0.3	14.0	10.3	1 430	1 060	15.1	1 540	10.5	15 500	31 300	
BNT911	55	80	13	1	0.6	14.6	11.6	1 490	1 180	17.0	1 730	10.7	13 800	27 600	
BNT912	60	85	13	1	0.6	15.3	12.8	1 560	1 300	18.7	1 910	10.8	12 800	25 700	
BNT913	65	90	13	1	0.6	15.5	13.4	1 580	1 370	19.7	2 010	10.9	12 000	24 000	

① Minimum allowable value for corner radius dimension  $r$  or  $r_1$ .





### Dynamic equivalent radial load

$$P_r = X F_r + Y F_a$$

$i \cdot f_0 \cdot F_a / C_{Or}$	$e$	Single row / Tandem				Back-to-back / Face-to-face			
		$F_d / F_r \leq e$		$F_d / F_r > e$		$F_d / F_r \leq e$		$F_d / F_r > e$	
		X	Y	X	Y	X	Y	X	Y
0.178	0.35			1.57		1.76		2.56	
0.357	0.36			1.53		1.71		2.48	
0.714	0.38			1.46		1.64		2.38	
1.07	0.4			1.42		1.59		2.31	
1.43	0.41	1	0	1.38	1	1.55	0.72	2.25	
2.14	0.43			1.33		1.49		2.16	
3.57	0.44			1.25		1.4		2.03	
5.35	0.47			1.18		1.32		1.92	
7.14	0.49			1.13		1.26		1.83	

### Static equivalent radial load

$$P_{Or} = X_0 F_r + Y_0 F_a$$

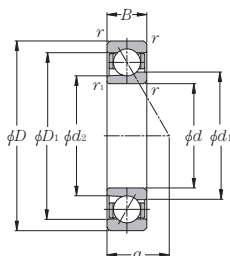
Single row / Tandem		Back-to-back / Face-to-face	
$X_0$	$Y_0$	$X_0$	$Y_0$
0.52	0.54	1.04	1.08

When  $P_{Or} < P_r$  with single-row or tandem arrangement,  $P_{Or} = P_r$ .

Load center mm	Internal free space cm <sup>3</sup> Single-row (approx.)	Mass kg Single-row (approx.)	Reference dimensions mm			Abutment and fillet dimensions mm					Part number
			$d_1$	$d_2$	$D_1$	$d_a$ min	$d_b$ min	$D_a$ max	$r_{as}$ max	$r_{ias}$ max	
5.2	0.3	0.010	14.0	12.7	18.0	12.2	11.2	20	0.3	0.15	BNT900
5.4	0.4	0.011	16.0	14.7	20.0	14.2	13.2	22	0.3	0.15	BNT901
6.4	0.6	0.016	19.0	17.4	24.0	17.2	16.2	26	0.3	0.15	BNT902
6.7	0.8	0.017	21.0	19.4	26.0	19.2	18.2	28	0.3	0.15	BNT903
8.4	1.4	0.037	25.5	23.5	31.4	22.5	21.5	34.5	0.3	0.15	BNT904
9.0	1.7	0.043	30.5	28.5	36.5	27.5	26.5	39.5	0.3	0.15	BNT905
9.7	1.9	0.049	35.5	33.5	41.5	32.5	31.5	44.5	0.3	0.15	BNT906
11.1	2.8	0.073	41.2	38.5	48.8	39.5	37.5	50.5	0.6	0.3	BNT907
12.9	4.5	0.11	47.0	44.4	55.0	44.5	42.5	57.5	0.6	0.3	BNT908
13.6	5.2	0.13	52.1	49.1	60.9	49.5	48	63.5	0.6	0.3	BNT909
14.2	6.2	0.13	56.6	53.6	65.4	54.5	52.5	67.5	0.6	0.3	BNT910
15.6	7.8	0.18	63.2	60.1	71.8	60.5	59.5	74.5	1	0.6	BNT911
16.3	8.3	0.20	68.1	65.1	76.9	65.5	64.5	79.5	1	0.6	BNT912
17.0	8.9	0.21	73.1	70.1	81.9	70.5	69.5	84.5	1	0.6	BNT913

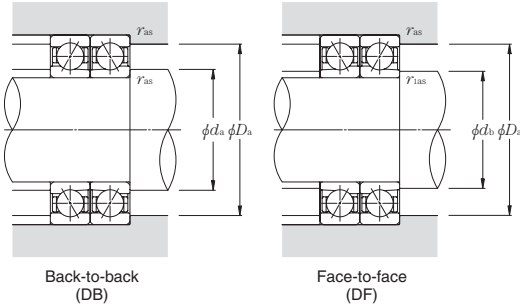
## Angular contact ball bearings for motors and lathes (steel ball type) BNT0 series

Contact angle 15°  $d$  10~70mm



Part number	Boundary dimensions					Basic load ratings				Static axial load capacity		Factor	Limiting speed		
	mm					dynamic	static	dynamic	static	kN	kgf		$f_0$	grease	oil
	$d$	$D$	$B$	$r_s$ min <sup>①</sup>	$r_{1s}$ min <sup>①</sup>	$C_r$	$C_{or}$	$C_r$	$C_{or}$	kN	kgf			min <sup>-1</sup>	lubrication
BNT000	10	26	8	0.3	0.15	3.75	1.45	385	148	2.07	211	8.3	60 300	120 100	
BNT001	12	28	8	0.3	0.15	4.15	1.73	420	176	2.48	253	8.8	52 700	104 900	
BNT002	15	32	9	0.3	0.15	4.75	2.22	485	226	3.20	325	9.2	46 000	91 500	
BNT003	17	35	10	0.3	0.15	5.90	2.70	600	275	3.90	395	9.0	41 500	82 700	
BNT004	20	42	12	0.6	0.3	8.00	3.95	815	405	5.70	580	9.2	34 300	68 300	
BNT005	25	47	12	0.6	0.3	8.95	4.85	910	495	7.05	720	9.6	30 000	59 700	
BNT006	30	55	13	1	0.6	11.6	6.75	1 180	685	9.75	995	9.8	25 100	50 000	
BNT007	35	62	14	1	0.6	14.6	8.95	1 490	910	13.0	1 320	9.8	20 100	40 200	
BNT008	40	68	15	1	0.6	15.7	10.4	1 600	1 060	15.1	1 540	10.0	18 100	36 100	
BNT009	45	75	16	1	0.6	18.6	12.6	1 900	1 290	18.4	1 870	10.1	16 300	32 500	
BNT010	50	80	16	1	0.6	19.9	14.3	2 030	1 460	20.9	2 130	10.2	15 000	30 000	
BNT011	55	90	18	1.1	0.6	26.1	18.7	2 660	1 910	27.3	2 780	10.1	13 200	26 400	
BNT012	60	95	18	1.1	0.6	26.8	20.0	2 730	2 040	29.2	2 980	10.3	12 300	24 700	
BNT013	65	100	18	1.1	0.6	28.4	22.4	2 890	2 290	32.5	3 350	10.4	11 600	23 200	
BNT014	70	110	20	1.1	0.6	36.0	28.1	3 650	2 870	41.0	4 200	10.3	10 600	21 300	

① Minimum allowable value for corner radius dimension  $r$  or  $r_1$ .



### Dynamic equivalent radial load

$$P_r = X F_r + Y F_a$$

$i \cdot f_0 \cdot F_a / C_{Or}$	$e$	Single row / Tandem				Back-to-back / Face-to-face			
		$F_d / F_r \leq e$		$F_d / F_r > e$		$F_d / F_r \leq e$		$F_d / F_r > e$	
		X	Y	X	Y	X	Y	X	Y
0.178	0.35			1.57		1.76		2.56	
0.357	0.36			1.53		1.71		2.48	
0.714	0.38			1.46		1.64		2.38	
1.07	0.4			1.42		1.59		2.31	
1.43	0.41	1	0	1.38	1	1.55	0.72	2.25	2.25
2.14	0.43			1.33		1.49		2.16	
3.57	0.44			1.25		1.4		2.03	
5.35	0.47			1.18		1.32		1.92	
7.14	0.49			1.13		1.26		1.83	

### Static equivalent radial load

$$P_{Or} = X_0 F_r + Y_0 F_a$$

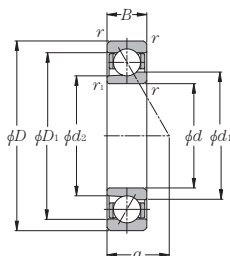
Single row / Tandem		Back-to-back / Face-to-face	
$X_0$	$Y_0$	$X_0$	$Y_0$
0.52	0.54	1.04	1.08

When  $P_{Or} < F_r$  with single-row or tandem arrangement,  $P_{Or} = F_r$ .

Load center mm	Internal free space cm <sup>3</sup> Single-row (approx.)	Mass kg Single-row (approx.)	Reference dimensions mm			Abutment and fillet dimensions mm					Part number
			$d_1$	$d_2$	$D_1$	$d_a$ min	$d_b$ min	$D_a$ max	$r_{as}$ max	$r_{ias}$ max	
6.5	0.9	0.015	14.6	13.0	21.0	12.5	11.2	23.5	0.3	0.15	BNT000
6.8	1.0	0.020	17.4	15.6	23.5	14.5	13.2	25.5	0.3	0.15	BNT001
7.7	1.3	0.029	20.4	18.5	26.5	17.5	16.2	29.5	0.3	0.15	BNT002
8.5	1.8	0.033	22.2	20.2	29.6	19.5	18.2	32.5	0.3	0.15	BNT003
10.3	3.0	0.057	27.4	24.9	35.5	24.5	22.5	37.5	0.6	0.3	BNT004
10.9	3.5	0.067	31.8	29.4	40.6	29.5	27.5	42.5	0.6	0.3	BNT005
12.3	4.3	0.11	38.4	35.5	47.8	35.5	34.5	49.5	1	0.6	BNT006
13.6	6.5	0.15	43.4	40.2	53.8	40.5	39.5	56.5	1	0.6	BNT007
14.8	8.0	0.18	48.8	45.7	59.4	45.5	44.5	62.5	1	0.6	BNT008
16.1	9.6	0.23	54.2	50.9	65.6	50.5	49.5	69.5	1	0.6	BNT009
16.8	11	0.26	59.6	55.9	70.2	55.5	54.5	74.5	1	0.6	BNT010
18.8	16	0.38	66.1	61.8	79.1	62	59.5	83	1	0.6	BNT011
19.5	19	0.40	71.1	66.8	84.1	67	64.5	88	1	0.6	BNT012
20.2	20	0.42	75.2	71.8	89.8	72	69.5	93	1	0.6	BNT013
22.2	27	0.56	82.3	77.7	97.9	77	74.5	103	1	0.6	BNT014

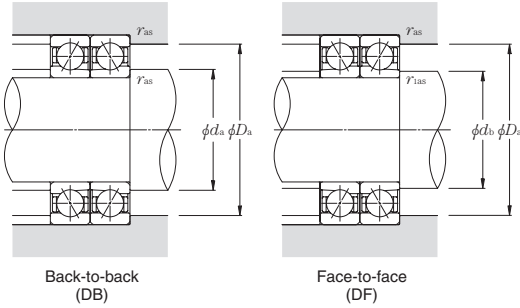
## Angular contact ball bearings for motors and lathes (steel ball type) BNT2 series

Contact angle 15°  $d$  10~80mm



Part number	Boundary dimensions					Basic load ratings				Static axial load capacity		Factor	Limiting speed		
	mm					dynamic	static	dynamic	static	kN	kgf		$f_0$	grease	oil
	$d$	$D$	$B$	$r_3$ min <sup>①</sup>	$r_3$ max <sup>①</sup>	$C_r$	$C_{or}$	$C_r$	$C_{or}$					kN	kgf
BNT200	10	30	9	0.6	0.3	4.15	1.71	420	175	2.46	250	8.7	53 300	106 800	
BNT201	12	32	10	0.6	0.3	5.40	2.28	550	232	3.25	330	8.5	48 400	97 000	
BNT202	15	35	11	0.6	0.3	6.85	2.97	700	300	4.25	430	8.5	42 600	85 400	
BNT203	17	40	12	0.6	0.3	8.55	3.80	870	385	5.40	555	8.5	37 000	74 100	
BNT204	20	47	14	1	0.6	11.2	5.35	1 140	545	7.70	785	8.8	30 900	61 900	
BNT205	25	52	15	1	0.6	12.7	6.70	1 290	685	9.70	990	9.2	27 300	54 700	
BNT206	30	62	16	1	0.6	17.6	9.60	1 800	980	13.9	1 420	9.2	22 900	45 900	
BNT207	35	72	17	1.1	0.6	23.2	13.1	2 370	1 330	18.8	1 920	9.1	18 100	36 000	
BNT208	40	80	18	1.1	0.6	27.8	16.5	2 830	1 680	23.8	2 430	9.3	16 200	32 100	
BNT209	45	85	19	1.1	0.6	31.0	18.9	3 200	1 920	27.3	2 780	9.3	14 900	29 600	
BNT210	50	90	20	1.1	0.6	32.5	20.8	3 350	2 120	30.0	3 050	9.5	13 900	27 500	
BNT211	55	100	21	1.5	1	40.5	26.2	4 150	2 670	38.0	3 850	9.5	12 300	24 400	
BNT212	60	110	22	1.5	1	49.0	32.5	5 000	3 300	47.0	4 800	9.5	11 000	21 800	
BNT213	65	120	23	1.5	1	53.5	36.0	5 450	3 650	52.0	5 300	9.5	10 300	20 400	
BNT214	70	125	24	1.5	1	58.0	39.5	5 900	4 000	57.0	5 800	9.6	9 700	19 400	
BNT215	75	130	25	1.5	1	60.5	43.0	6 200	4 400	62.5	6 350	9.7	9 200	18 300	
BNT216	80	140	26	2	1	71.0	50.5	7 250	5 150	73.5	7 500	9.7	8 600	17 200	

① Minimum allowable value for corner radius dimension  $r$  or  $r_1$ .



### Dynamic equivalent radial load

$$P_r = X F_r + Y F_a$$

$i \cdot f_0 \cdot F_a / C_{Or}$	$e$	Single row / Tandem		Back-to-back / Face-to-face	
		$F_d / F_r \leq e$	$F_d / F_r > e$	$F_d / F_r \leq e$	$F_d / F_r > e$
		X	Y	X	Y
0.178	0.35			1.57	1.76
0.357	0.36			1.53	1.71
0.714	0.38			1.46	1.64
1.07	0.4			1.42	1.59
1.43	0.41	1	0	1.38	1.55
2.14	0.43			1.33	1.49
3.57	0.44			1.25	1.4
5.35	0.47			1.18	1.32
7.14	0.49			1.13	1.26

### Static equivalent radial load

$$P_{Or} = X_0 F_r + Y_0 F_a$$

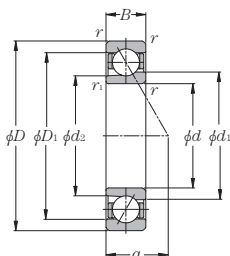
Single row / Tandem		Back-to-back / Face-to-face	
$X_0$	$Y_0$	$X_0$	$Y_0$
0.52	0.54	1.04	1.08

When  $P_{Or} < F_r$  with single-row or tandem arrangement,  $P_{Or} = F_r$ .

Load center mm	Internal free space cm <sup>3</sup> Single-row (approx.)	Mass kg Single-row (approx.)	Reference dimensions mm			Abutment and fillet dimensions mm					Part number
			$d_1$	$d_2$	$D_1$	$d_a$ min	$d_b$ min	$D_a$ max	$r_{as}$ max	$r_{ias}$ max	
7.2	1.1	0.019	17.0	15.0	23.0	14.5	12.5	25.5	0.6	0.3	BNT200
8.0	1.5	0.025	18.4	16.2	26.0	16.5	14.5	27.5	0.6	0.3	BNT201
8.9	2.2	0.035	20.8	18.4	29.4	19.5	17.5	30.5	0.6	0.3	BNT202
9.9	2.9	0.054	24.2	21.4	33.6	21.5	19.5	35.5	0.6	0.3	BNT203
11.7	4.6	0.092	29.4	26.2	39.4	25.5	24.5	41.5	1	0.6	BNT204
12.8	6.1	0.13	33.8	30.7	44.2	30.5	29.5	46.5	1	0.6	BNT205
14.3	8.3	0.20	40.6	36.6	52.6	35.5	34.5	56.5	1	0.6	BNT206
15.8	10	0.29	46.8	42.0	60.6	42	39.5	65	1	0.6	BNT207
17.2	13	0.38	53.0	47.7	67.0	47	44.5	73	1	0.6	BNT208
18.3	16	0.44	57.3	51.9	73.0	52	49.5	78	1	0.6	BNT209
19.5	20	0.46	62.2	56.8	78.0	57	54.5	83	1	0.6	BNT210
21.0	25	0.61	69.0	62.8	86.4	63.5	60.5	91.5	1.5	1	BNT211
22.8	32	0.78	77.0	70.2	96.4	68.5	65.5	101.5	1.5	1	BNT212
24.1	37	1.01	82.5	75.3	102.5	73.5	70.5	111.5	1.5	1	BNT213
25.2	47	1.08	87.0	79.5	108.0	78.5	75.5	116.5	1.5	1	BNT214
26.6	54	1.17	93.0	85.5	114.5	83.5	80.5	121.5	1.5	1	BNT215
27.9	58	1.45	98.1	90.4	122.0	90	85.5	130	2	1	BNT216

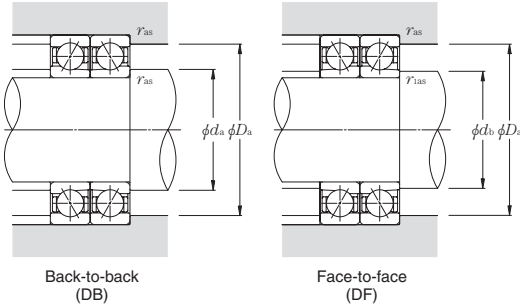
## Angular contact ball bearings for motors and lathes (ceramic ball type) 5S-BNT9 series

Contact angle 15°  $d$  10~65mm



Part number	Boundary dimensions						Basic load ratings				Static axial load capacity		Factor $f_0$	Limiting speed $\text{min}^{-1}$	
	mm						dynamic	static	dynamic	static	kN	kgf		grease lubrication	oil lubrication
	$d$	$D$	$B$	$r_3 \text{ min}^{\text{①}}$	$r_3 \text{ min}^{\text{①}}$		$C_r$	$C_{or}$	$C_r$	$C_{or}$					
5S-BNT900	10	22	6	0.3	0.15		2.30	0.69	235	70	0.905	92	6.4	72 500	145 600
5S-BNT901	12	24	6	0.3	0.15		2.57	0.84	262	86	1.11	113	6.7	64 400	129 400
5S-BNT902	15	28	7	0.3	0.15		3.70	1.22	375	124	1.60	163	6.6	54 000	108 400
5S-BNT903	17	30	7	0.3	0.15		3.90	1.35	395	138	1.78	182	6.7	49 400	99 100
5S-BNT904	20	37	9	0.3	0.15		5.60	2.07	570	211	2.74	279	6.8	40 700	81 800
5S-BNT905	25	42	9	0.3	0.15		6.00	2.46	610	251	3.25	330	7.0	34 600	69 600
5S-BNT906	30	47	9	0.3	0.15		6.35	2.84	650	290	3.80	385	7.2	30 100	60 500
5S-BNT907	35	55	10	0.6	0.3		10.1	4.40	1 030	445	5.80	590	7.0	24 400	49 300
5S-BNT908	40	62	12	0.6	0.3		10.7	5.05	1 090	515	6.70	685	7.2	21 600	43 500
5S-BNT909	45	68	12	0.6	0.3		13.2	6.35	1 350	650	8.45	865	7.2	19 500	39 300
5S-BNT910	50	72	12	0.6	0.3		14.0	7.15	1 430	730	9.55	975	7.3	18 000	36 400
5S-BNT911	55	80	13	1	0.6		14.6	8.00	1 490	820	10.7	1 090	7.4	16 000	32 000
5S-BNT912	60	85	13	1	0.6		15.3	8.85	1 560	900	11.8	1 200	7.5	14 900	29 800
5S-BNT913	65	90	13	1	0.6		15.5	9.30	1 580	945	12.4	1 270	7.5	13 900	27 900

① Minimum allowable value for corner radius dimension  $r$  or  $r_1$ .



### Dynamic equivalent radial load

$$P_r = X F_r + Y F_a$$

$i \cdot f_0 \cdot F_a / C_{Or}$	$e$	Single row / Tandem				Back-to-back / Face-to-face			
		$F_d / F_r \leq e$		$F_d / F_r > e$		$F_d / F_r \leq e$		$F_d / F_r > e$	
		X	Y	X	Y	X	Y	X	Y
0.178	0.35			1.57		1.76		2.56	
0.357	0.36			1.53		1.71		2.48	
0.714	0.38			1.46		1.64		2.38	
1.07	0.4			1.42		1.59		2.31	
1.43	0.41	1	0	1.38	1	1.55	0.72	2.25	
2.14	0.43			1.33		1.49		2.16	
3.57	0.44			1.25		1.4		2.03	
5.35	0.47			1.18		1.32		1.92	
7.14	0.49			1.13		1.26		1.83	

### Static equivalent radial load

$$P_{Or} = X_0 F_r + Y_0 F_a$$

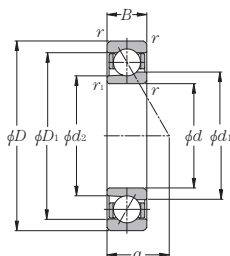
Single row / Tandem		Back-to-back / Face-to-face	
$X_0$	$Y_0$	$X_0$	$Y_0$
0.52	0.54	1.04	1.08

When  $P_{Or} < P_r$  with single-row or tandem arrangement,  $P_{Or} = P_r$ .

Load center mm	Internal free space cm <sup>3</sup> Single-row (approx.)	Mass kg Single-row (approx.)	Reference dimensions mm			Abutment and fillet dimensions mm					Part number
			$d_1$	$d_2$	$D_1$	$d_a$ min	$d_b$ min	$D_a$ max	$r_{as}$ max	$r_{ias}$ max	
5.2	0.3	0.009	14.0	12.7	18.0	12.2	11.2	20	0.3	0.15	5S-BNT900
5.4	0.4	0.010	16.0	14.7	20.0	14.2	13.2	22	0.3	0.15	5S-BNT901
6.4	0.6	0.014	19.0	17.4	24.0	17.2	16.2	26	0.3	0.15	5S-BNT902
6.7	0.8	0.015	21.0	19.4	26.0	19.2	18.2	28	0.3	0.15	5S-BNT903
8.4	1.4	0.033	25.5	23.5	31.4	22.5	21.5	34.5	0.3	0.15	5S-BNT904
9.0	1.7	0.039	30.5	28.5	36.5	27.5	26.5	39.5	0.3	0.15	5S-BNT905
9.7	1.9	0.044	35.5	33.5	41.5	32.5	31.5	44.5	0.3	0.15	5S-BNT906
11.1	2.8	0.063	41.2	38.5	48.8	39.5	37.5	50.5	0.6	0.3	5S-BNT907
12.9	4.5	0.100	47.0	44.4	55.0	44.5	42.5	57.5	0.6	0.3	5S-BNT908
13.6	5.2	0.110	52.1	49.1	60.9	49.5	48	63.5	0.6	0.3	5S-BNT909
14.2	6.2	0.110	56.6	53.6	65.4	54.5	52.5	67.5	0.6	0.3	5S-BNT910
15.6	7.8	0.160	63.2	60.1	71.8	60.5	59.5	74.5	1	0.6	5S-BNT911
16.3	8.3	0.170	68.1	65.1	76.9	65.5	64.5	79.5	1	0.6	5S-BNT912
17.0	8.9	0.190	73.1	70.1	81.9	70.5	69.5	84.5	1	0.6	5S-BNT913

## Angular contact ball bearings for motors and lathes (ceramic ball type) 5S-BNT0 series

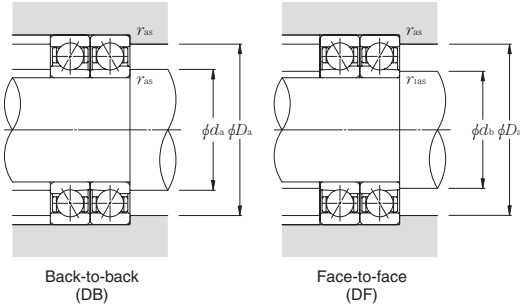
Contact angle 15°  $d$  10~70mm



Part number	Boundary dimensions					Basic load ratings				Static axial load capacity		Factor	Limiting speed		
	mm					dynamic		static		kN	kgf		$f_0$	grease	oil
	$d$	$D$	$B$	$r_1$ min <sup>①</sup>	$r_2$ min <sup>①</sup>	$C_r$	$C_{or}$	$C_r$	$C_{or}$					kN	kgf
5S-BNT000	10	26	8	0.3	0.15	3.75	1.01	385	103	1.31	133	5.7	70 100	140 200	
5S-BNT001	12	28	8	0.3	0.15	4.15	1.20	420	122	1.57	160	6.1	61 200	122 400	
5S-BNT002	15	32	9	0.3	0.15	4.75	1.54	485	157	2.02	206	6.4	53 400	106 800	
5S-BNT003	17	35	10	0.3	0.15	5.90	1.87	600	191	2.45	250	6.3	48 300	96 500	
5S-BNT004	20	42	12	0.6	0.3	8.00	2.74	815	279	3.60	365	6.4	39 800	79 700	
5S-BNT005	25	47	12	0.6	0.3	8.95	3.35	910	345	4.45	455	6.7	34 900	69 700	
5S-BNT006	30	55	13	1	0.6	11.6	4.65	1 180	475	6.15	630	6.8	29 200	58 400	
5S-BNT007	35	62	14	1	0.6	14.6	6.20	1 490	630	8.20	835	6.8	23 500	46 900	
5S-BNT008	40	68	15	1	0.6	15.7	7.20	1 600	735	9.55	975	7.0	21 100	42 100	
5S-BNT009	45	75	16	1	0.6	18.6	8.75	1 900	890	11.6	1 180	7.0	19 000	37 900	
5S-BNT010	50	80	16	1	0.6	19.9	9.90	2 030	1 010	13.2	1 340	7.1	17 500	35 000	
5S-BNT011	55	90	18	1.1	0.6	26.1	13.0	2 660	1 320	17.2	1 760	7.0	15 500	31 000	
5S-BNT012	60	95	18	1.1	0.6	26.8	13.9	2 730	1 420	18.4	1 880	7.1	14 500	29 000	
5S-BNT013	65	100	18	1.1	0.6	28.4	15.5	2 890	1 580	20.7	2 110	7.2	13 600	27 300	
5S-BNT014	70	110	20	1.1	0.6	36.0	19.5	3 650	1 990	25.9	2 640	7.1	12 500	25 000	

① Minimum allowable value for corner radius dimension  $r$  or  $r_1$ .





### Dynamic equivalent radial load

$$P_r = X F_r + Y F_a$$

$i \cdot f_0 \cdot F_a / C_{Or}$	$e$	Single row / Tandem				Back-to-back / Face-to-face			
		$F_d / F_r \leq e$		$F_d / F_r > e$		$F_d / F_r \leq e$		$F_d / F_r > e$	
		X	Y	X	Y	X	Y	X	Y
0.178	0.35			1.57		1.76		2.56	
0.357	0.36			1.53		1.71		2.48	
0.714	0.38			1.46		1.64		2.38	
1.07	0.4			1.42		1.59		2.31	
1.43	0.41	1	0	1.38	1	1.55	0.72	2.25	2.25
2.14	0.43			1.33		1.49		2.16	
3.57	0.44			1.25		1.4		2.03	
5.35	0.47			1.18		1.32		1.92	
7.14	0.49			1.13		1.26		1.83	

### Static equivalent radial load

$$P_{Or} = X_0 F_r + Y_0 F_a$$

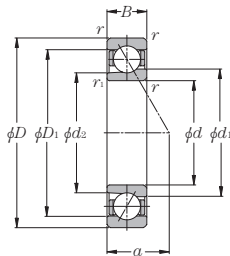
Single row / Tandem		Back-to-back / Face-to-face	
$X_0$	$Y_0$	$X_0$	$Y_0$
0.52	0.54	1.04	1.08

When  $P_{Or} < F_r$  with single-row or tandem arrangement,  $P_{Or} = F_r$ .

Load center mm	Internal free space cm <sup>3</sup> Single-row (approx.)	Mass kg Single-row (approx.)	Reference dimensions mm			Abutment and fillet dimensions mm					Part number
			$d_1$	$d_2$	$D_1$	$d_a$ min	$d_b$ min	$D_a$ max	$r_{as}$ max	$r_{ias}$ max	
6.5	0.9	0.013	14.6	13.0	21.0	12.5	11.2	23.5	0.3	0.15	5S-BNT000
6.8	1.0	0.018	17.4	15.6	23.5	14.5	13.2	25.5	0.3	0.15	5S-BNT001
7.7	1.3	0.026	20.4	18.5	26.5	17.5	16.2	29.5	0.3	0.15	5S-BNT002
8.5	1.8	0.029	22.2	20.2	29.6	19.5	18.2	32.5	0.3	0.15	5S-BNT003
10.3	3.0	0.050	27.4	24.9	35.5	24.5	22.5	37.5	0.6	0.3	5S-BNT004
10.9	3.5	0.060	31.8	29.4	40.6	29.5	27.5	42.5	0.6	0.3	5S-BNT005
12.3	4.3	0.10	38.4	35.5	47.8	35.5	34.5	49.5	1	0.6	5S-BNT006
13.6	6.5	0.13	43.4	40.2	53.8	40.5	39.5	56.5	1	0.6	5S-BNT007
14.8	8.0	0.16	48.8	45.7	59.4	45.5	44.5	62.5	1	0.6	5S-BNT008
16.1	9.6	0.21	54.2	50.9	65.6	50.5	49.5	69.5	1	0.6	5S-BNT009
16.8	11	0.24	59.6	55.9	70.2	55.5	54.5	74.5	1	0.6	5S-BNT010
18.8	16	0.35	66.1	61.8	79.1	62	59.5	83	1	0.6	5S-BNT011
19.5	19	0.36	71.1	66.8	84.1	67	64.5	88	1	0.6	5S-BNT012
20.2	20	0.37	75.2	71.8	89.8	72	69.5	93	1	0.6	5S-BNT013
22.2	27	0.50	82.3	77.7	97.9	77	74.5	103	1	0.6	5S-BNT014

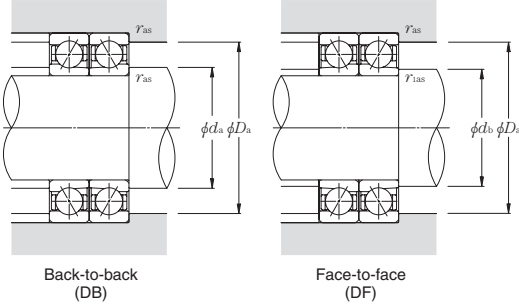
## Angular contact ball bearings for motors and lathes (ceramic ball type) 5S-BNT2 series

Contact angle 15°  $d$  10~80mm



Part number	Boundary dimensions					Basic load ratings				Static axial load capacity		Factor	Limiting speed		
	mm					dynamic	static	dynamic	static	kN	kgf		$f_0$	grease	oil
	$d$	$D$	$B$	$r_3$ min <sup>①</sup>	$r_3$ max <sup>①</sup>	$C_r$	$C_{or}$	$C_r$	$C_{or}$					lubrication	lubrication
5S-BNT200	10	30	9	0.6	0.3	4.15	1.19	420	121	1.55	158	6.0	63 000	126 000	
5S-BNT201	12	32	10	0.6	0.3	5.40	1.58	550	161	2.05	209	5.9	57 300	114 500	
5S-BNT202	15	35	11	0.6	0.3	6.85	2.05	700	210	2.67	272	5.9	50 400	100 800	
5S-BNT203	17	40	12	0.6	0.3	8.55	2.63	870	268	3.40	350	5.9	43 800	87 500	
5S-BNT204	20	47	14	1	0.6	11.2	3.70	1 140	380	4.85	495	6.1	36 500	73 000	
5S-BNT205	25	52	15	1	0.6	12.7	4.65	1 290	475	6.10	625	6.4	32 300	64 600	
5S-BNT206	30	62	16	1	0.6	17.6	6.70	1 800	680	8.80	895	6.4	27 100	54 200	
5S-BNT207	35	72	17	1.1	0.6	23.2	9.05	2 370	925	11.9	1 210	6.3	21 300	42 500	
5S-BNT208	40	80	18	1.1	0.6	27.8	11.4	2 830	1 170	15.0	1 530	6.4	19 000	37 900	
5S-BNT209	45	85	19	1.1	0.6	31.0	13.1	3 200	1 330	17.2	1 750	6.5	17 500	35 000	
5S-BNT210	50	90	20	1.1	0.6	32.5	14.4	3 350	1 470	19.0	1 940	6.6	16 300	32 500	
5S-BNT211	55	100	21	1.5	1	40.5	18.1	4 150	1 850	23.9	2 440	6.6	14 500	28 900	
5S-BNT212	60	110	22	1.5	1	49.0	22.4	5 000	2 290	29.5	3 000	6.6	12 900	25 900	
5S-BNT213	65	120	23	1.5	1	53.5	24.9	5 450	2 530	33.0	3 350	6.6	12 100	24 200	
5S-BNT214	70	125	24	1.5	1	58.0	27.3	5 900	2 790	36.0	3 650	6.6	11 500	23 000	
5S-BNT215	75	130	25	1.5	1	60.5	29.8	6 200	3 050	39.5	4 000	6.7	10 800	21 600	
5S-BNT216	80	140	26	2	1	71.0	35.0	7 250	3 600	46.5	4 750	6.7	10 200	20 400	

① Minimum allowable value for corner radius dimension  $r$  or  $r_1$ .



### Dynamic equivalent radial load

$$P_r = X F_r + Y F_a$$

$i \cdot f_0 \cdot F_a / C_{Or}$	$e$	Single row / Tandem		Back-to-back / Face-to-face	
		$F_d / F_r \leq e$	$F_d / F_r > e$	$F_d / F_r \leq e$	$F_d / F_r > e$
		X	Y	X	Y
0.178	0.35			1.57	1.76
0.357	0.36			1.53	1.71
0.714	0.38			1.46	1.64
1.07	0.4			1.42	1.59
1.43	0.41	1	0	1.38	1.55
2.14	0.43			1.33	1.49
3.57	0.44			1.25	1.4
5.35	0.47			1.18	1.32
7.14	0.49			1.13	1.26

### Static equivalent radial load

$$P_{Or} = X_0 F_r + Y_0 F_a$$

Single row / Tandem		Back-to-back / Face-to-face	
$X_0$	$Y_0$	$X_0$	$Y_0$
0.52	0.54	1.04	1.08

When  $P_{Or} < F_r$  with single-row or tandem arrangement,  $P_{Or} = F_r$ .

Load center mm	Internal free space cm <sup>3</sup> Single-row (approx.)	Mass kg Single-row (approx.)	Reference dimensions mm			Abutment and fillet dimensions mm					Part number
			$d_1$	$d_2$	$D_1$	$d_a$ min	$d_b$ min	$D_a$ max	$r_{as}$ max	$r_{ias}$ max	
7.2	1.1	0.017	17.0	15.0	23.0	14.5	12.5	25.5	0.6	0.3	5S-BNT200
8.0	1.5	0.021	18.4	16.2	26.0	16.5	14.5	27.5	0.6	0.3	5S-BNT201
8.9	2.2	0.030	20.8	18.4	29.4	19.5	17.5	30.5	0.6	0.3	5S-BNT202
9.9	2.9	0.046	24.2	21.4	33.6	21.5	19.5	35.5	0.6	0.3	5S-BNT203
11.7	4.6	0.080	29.4	26.2	39.4	25.5	24.5	41.5	1	0.6	5S-BNT204
12.8	6.1	0.11	33.8	30.7	44.2	30.5	29.5	46.5	1	0.6	5S-BNT205
14.3	8.3	0.18	40.6	36.6	52.6	35.5	34.5	56.5	1	0.6	5S-BNT206
15.8	10	0.25	46.8	42.0	60.6	42	39.5	65	1	0.6	5S-BNT207
17.2	13	0.33	53.0	47.7	67.0	47	44.5	73	1	0.6	5S-BNT208
18.3	16	0.37	57.3	51.9	73.0	52	49.5	78	1	0.6	5S-BNT209
19.5	20	0.39	62.2	56.8	78.0	57	54.5	83	1	0.6	5S-BNT210
21.0	25	0.52	69.0	62.8	86.4	63.5	60.5	91.5	1.5	1	5S-BNT211
22.8	32	0.65	77.0	70.2	96.4	68.5	65.5	101.5	1.5	1	5S-BNT212
24.1	37	0.86	82.5	75.3	102.5	73.5	70.5	111.5	1.5	1	5S-BNT213
25.2	47	0.91	87.0	79.5	108.0	78.5	75.5	116.5	1.5	1	5S-BNT214
26.6	54	0.98	93.0	85.5	114.5	83.5	80.5	121.5	1.5	1	5S-BNT215
27.9	58	1.21	98.1	90.4	122.0	90	85.5	130	2	1	5S-BNT216





## Main Spindle Bearings

### 10. Cylindrical Roller Bearings CONTENTS

<b>10. Cylindrical roller bearings</b> .....	210~237
① Double-row cylindrical roller bearings .....	210
② Single-row cylindrical roller bearings .....	210
③ Bearing designations .....	211
④ Accuracy of tapered bore .....	211
⑤ Accuracy of cylindrical roller bearings .....	212
⑥ Radial internal clearance of cylindrical roller bearings .....	214
⑦ Recommended fit of high-precision cylindrical roller bearings .....	216
⑧ Recommended lubrication specifications .....	217
⑨ Ultra high speed double row cylindrical roller bearings NN30HSRT6 type .....	218
⑩ Ultra high-speed single row cylindrical roller bearings N10HSRT6 type .....	220
⑪ Eco-friendly air-oil lubricated ultra high speed single row cylindrical roller bearings N10HSLT6 type .....	222
⑫ Dimension tables for cylindrical roller bearings Double-row cylindrical roller bearings .....	224
High speed single-row cylindrical roller bearings .....	230
Ultra high-speed single row cylindrical roller bearings .....	234
Eco-friendly ultra high-speed single row cylindrical roller bearings .....	236
⑬ Taper gage and internal clearance adjustment gage for NTN precision cylindrical roller bearings .....	238
⑭ Dimension tables for taper gage .....	238
⑮ Dimension table for mounted internal clearance adjustment gage .....	239

## 10. Cylindrical Roller Bearings

In a cylindrical roller bearing, the rollers and raceways are in line contact. Consequently this type of bearing can support a larger radial load than a point-contact ball bearing. Also, its design is suitable for high-speed operation.

A cylindrical roller bearing used for the main spindle of a machine tool can have either a double- or single-row configuration, and certain variants have a tapered bore so the radial internal clearance can be adjusted.

### ① Double-row cylindrical roller bearings

Double-row cylindrical roller bearings are available in two types, NN and NNU, and two series, 30 and 49. The rollers in the NN type bearing are guided by the ribs of the inner ring. The rollers in the NNU type bearing are guided by the ribs of the outer ring. Bearings are available with either a tapered bore (which allows adjustment of radial internal clearance of bearing) or a standard cylindrical bore.

The bearings come in two types, standard type and high-speed HS type. Standard cage is machined brass.

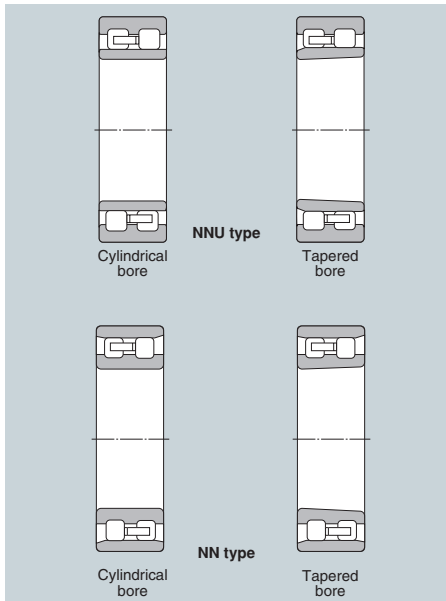


Fig. 10.1

### ② Single-row cylindrical roller bearings

Single-row cylindrical roller bearings are available in two types, high-speed N10HS type and ultra high-speed N10HSRT6 type. The N10HS type bearings have high-strength machined brass cages, while the N10HSR type bearings have special molded resin cages, which can be used for both grease lubrication and air-oil lubrication. The eco-friendly N10HSLT6 type is a variation from the high-speed N10HSRT6 type bearing and can be used with air-oil lubrication only.

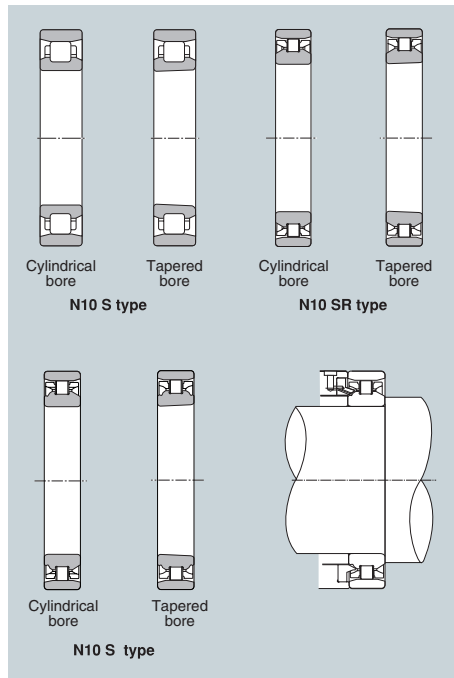
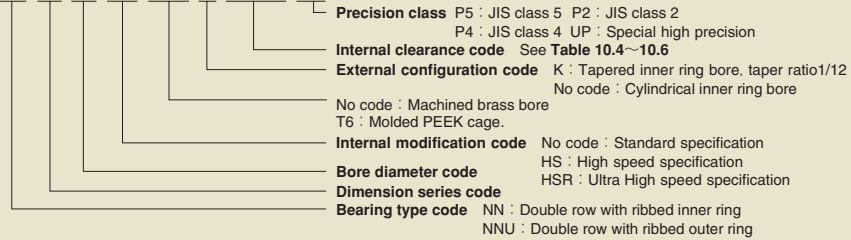


Fig. 10.2

### ③ Bearing designations

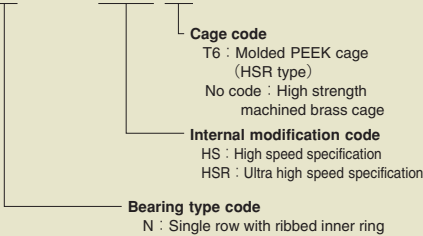
#### NN49, 30, NNU49 type

#### NN 30 20 HS RT6 K C0NA P4



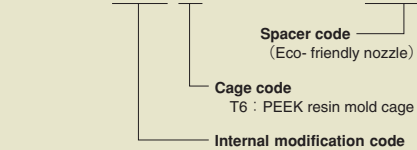
#### N10HS, N10HSR type

#### N 10 20 HSR T6 K C0NA P4



#### N10HSL type

#### N 10 20 HSL T6 K C0NA P4 +TKZ



### ④ Accuracy of tapered bore

NTN specifies the accuracies of tapered bores conforming with JIS Classes 4 and 2 as shown below. Poor accuracies of the tapered bore lead to misalignment of the inner ring, causing poor performance, premature seizure and flaking. Use of a taper gauge is recommended for higher accuracy of the main spindle. Refer to "6 Handling of Bearings, ③ Tapered bore cylindrical roller bearing and main spindle taper angle" in the Technical Data section for more information on taper angle.

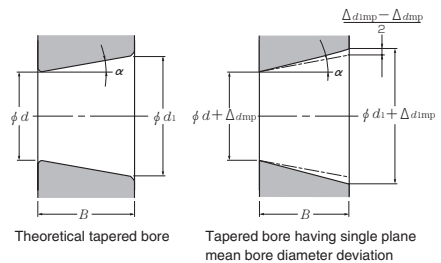


Table 10.1 Tolerance of taper-bored bearings

Unit:  $\mu\text{m}$

d mm		$\Delta d_{tmp}$				$\Delta d_{tmp} - \Delta d_{tmp}$ (approx.)				$V_{dp}$	
over	incl.	Class 4	Class 2	Class 4	Class 2	Class 4	Class 2	Class 4	Class 2	max	
18	30	+10	0	+6	0	+4	0	+3	0	2.5	1.5
30	50	+12	0	+7	0	+5	0	+3.5	0	2.5	1.5
50	80	+15	0	+8	0	+6	0	+4	0	3	2
80	120	+20	0	+10	0	+7	0	+5	0	4	2.5
120	180	+25	0	+12	0	+8	0	+6	0	5	3.5
180	250	+29	0	+14	0	+9	0	+7	0	7	4.5
250	315	+32	0	—	—	+10	0	—	—	8	—
315	400	+36	0	—	—	+12	0	—	—	9	—
400	500	+40	0	—	—	+14	0	—	—	10	—

Note: NTN specification

Tolerance of 1/12 taper angle  $4'46''18.8''^{+24}{}_{0}$

$$\alpha = 2'23''9.4''$$

$$d_1 = d + \frac{1}{12} B$$

$V_{dp}$  : Single radial plane bore diameter variation

$\Delta d_{mp}$  : Single plane mean bore diameter deviation  
(at theoretical small end on tapered bore)

$\Delta d_{tmp}$  : Single plane mean bore diameter deviation  
(at theoretical large end on tapered bore)

B : Nominal inner ring width

Fig. 10.3

⑤ Accuracy of cylindrical roller bearings

Table 10.2 Inner rings

Nominal bore diameter $d$		Deviation of mean bore diameter in a single plane $d_{mp}$						Variation of bore diameter in a single plane $V_{dsp}$						Variation of mean bore diameter $V_{dmp}$			Inner ring radial runout $K_{ia}$		
mm over incl.		Class 5 high low		Class 4 ① high low		Class 2 ① high low		Diameter series 9 Class 5 Class 4 Class 2 max			Diameter series 0 Class 5 Class 4 Class 2 max			Class 5 Class 4 Class 2 max			Class 5 Class 4 Class 2 max		
18	30	0	-6	0	-5	0	-2.5	6	5	2.5	5	4	2.5	3	2.5	1.5	4	3	2.5
30	50	0	-8	0	-6	0	-2.5	8	6	2.5	6	5	2.5	4	3	1.5	5	4	2.5
50	80	0	-9	0	-7	0	-4	9	7	4	7	5	4	5	3.5	2	5	4	2.5
80	120	0	-10	0	-8	0	-5	10	8	5	8	6	5	5	4	2.5	6	5	2.5
120	150	0	-13	0	-10	0	-7	13	10	7	10	8	7	7	5	3.5	8	6	2.5
150	180	0	-13	0	-10	0	-7	13	10	7	10	8	7	7	5	3.5	8	6	5
180	250	0	-15	0	-12	0	-8	15	12	8	12	9	8	8	6	4	10	8	5
250	315	0	-18	-	-	-	-	18	-	-	14	-	-	9	-	-	13	-	-
315	400	0	-23	-	-	-	-	23	-	-	18	-	-	12	-	-	15	-	-
400	500	-	-	-	-	-	-	-	-	-	-	-	-	-	-	-	-	-	-

① The tolerance of bore diameter deviation  $d_s$  applicable to classes 4 and 2 is the same as the tolerance of single plane mean bore diameter deviation  $d_{mp}$ .

Table 10.3 Outer rings

Nominal bore diameter $D$		Deviation of mean outside diameter in a single plane $D_{mp}$						Variation of outside diameter in a single plane $V_{Dsp}$						Variation of mean outside diameter $V_{Dmp}$			Outer ring radial runout $K_{ea}$		
mm over incl.		Class 5 high low		Class 4 ② high low		Class 2 ② high low		Diameter series 9 Class 5 Class 4 Class 2 max			Diameter series 0 Class 5 Class 4 Class 2 max			Class 5 Class 4 Class 2 max			Class 5 Class 4 Class 2 max		
30	50	0	-7	0	-6	0	-4	7	6	4	5	5	4	4	3	2	7	5	2.5
50	80	0	-9	0	-7	0	-4	9	7	4	7	5	4	5	3.5	2	8	5	4
80	120	0	-10	0	-8	0	-5	10	8	5	8	6	5	5	4	2.5	10	6	5
120	150	0	-11	0	-9	0	-5	11	9	5	8	7	5	6	5	2.5	11	7	5
150	180	0	-13	0	-10	0	-7	13	10	7	10	8	7	7	5	3.5	13	8	5
180	250	0	-15	0	-11	0	-8	15	11	8	11	8	8	8	6	4	15	10	7
250	315	0	-18	0	-13	0	-8	18	13	8	14	10	8	9	7	4	18	11	7
315	400	0	-20	0	-15	0	-10	20	15	10	15	11	10	10	8	5	20	13	8
400	500	0	-23	-	-	-	-	23	-	-	17	-	-	12	-	-	23	-	-
500	630	0	-28	-	-	-	-	28	-	-	21	-	-	14	-	-	25	-	-
630	800	0	-35	-	-	-	-	35	-	-	26	-	-	18	-	-	30	-	-

② The tolerance of outside diameter deviation  $D_s$  applicable to classes 4 and 2 is the same as the tolerance of mean single plane outside diameter deviation  $D_{mp}$ .



Unit:  $\mu\text{m}$

Perpendicularity of inner ring face with respect to the bore $S_d$			Width deviation $B_s$ Single bearing				Width variation $VB_s$		
Class 5	Class 4	Class 2	Class 5	Class 4	Class 2	Class 5	Class 4	Class 2	
max			high	low	high	low	max		
8	4	1.5	0	-120	0	-120	5	2.5	1.5
8	4	1.5	0	-120	0	-120	5	3	1.5
8	5	1.5	0	-150	0	-150	6	4	1.5
9	5	2.5	0	-200	0	-200	7	4	2.5
10	6	2.5	0	-250	0	-250	8	5	2.5
10	6	4	0	-250	0	-300	8	5	4
11	7	5	0	-300	0	-350	10	6	5
13	—	—	0	-350	—	—	13	—	—
15	—	—	0	-400	—	—	15	—	—
—	—	—	—	—	—	—	—	—	—

Unit:  $\mu\text{m}$

Perpendicularity of outer ring outside surface with respect to the face $S_D$			Width deviation $C_s$		Width variation $VC_s$		
Class 5	Class 4	Class 2	All classes		Class 5	Class 4	Class 2
max					max		
8	4	1.5	Identical to $B_s$ relative to $d$ on the same bearing.		5	2.5	1.5
8	4	1.5			6	3	1.5
9	5	2.5			8	4	2.5
10	5	2.5			8	5	2.5
10	5	2.5			8	5	2.5
11	7	4			10	7	4
13	8	5			11	7	5
13	10	7			13	8	7
15	—	—			15	—	—
18	—	—			18	—	—
20	—	—	20	—	—		

## ⑥ Radial internal clearance of cylindrical roller bearings

### ■ Non-interchangeable radial internal clearance

Two types of radial internal clearance are available: non-interchangeable radial internal clearance for which the combination of outer ring and inner ring cannot be changed; and interchangeable radial internal clearance that allows for different outer ring and inner ring combinations. The clearances listed are common to both double-row and the single-row cylindrical roller

bearings. For machine components including high-precision machine tool main spindle, bearings with non-interchangeable radial internal clearance and a small clearance range are used. If a double-row tapered bore bearing is used and the desired mounted internal clearance is close to zero, use of clearance in the range between C9NA and C1NA is recommended. Cylindrical bore bearings with non-interchangeable radial internal clearance are also available. For details, contact NTN Engineering.

**Table 10.4 Cylindrical bore bearings**

Unit:  $\mu\text{m}$

Nominal bore diameter $d$ mm		Cylindrical bore bearing					
		C1NA		C2NA		NA ①	
over	incl.	min	max	min	max	min	max
24	30	5	10	10	25	25	35
30	40	5	12	12	25	25	40
40	50	5	15	15	30	30	45
50	65	5	15	15	35	35	50
65	80	10	20	20	40	40	60
80	100	10	25	25	45	45	70
100	120	10	25	25	50	50	80
120	140	15	30	30	60	60	90
140	160	15	35	35	65	65	100
160	180	15	35	35	75	75	110
180	200	20	40	40	80	80	120
200	225	20	45	45	90	90	135
225	250	25	50	50	100	100	150
250	280	25	55	55	110	110	165
280	315	30	60	60	120	120	180
315	355	30	65	65	135	135	200
355	400	35	75	75	150	150	225
400	450	45	85	85	170	170	255
450	500	50	95	95	190	190	285

① The code for normal internal clearance is "NA". Ex: N1006HSNA

**Table 10.5 Tapered bore bearings**

Unit:  $\mu\text{m}$

Nominal bore diameter $d$ mm		Tapered bore bearing									
		C9NA ②		C0NA ②		C1NA ②		C2NA		NA ①	
over	incl.	min	max	min	max	min	max	min	max	min	max
24	30	5	10	10	20	10	25	25	35	40	50
30	40	5	12	10	20	12	25	25	40	45	55
40	50	5	15	10	20	15	30	30	45	50	65
50	65	5	15	10	20	15	35	35	50	55	75
65	80	10	20	15	30	20	40	40	60	70	90
80	100	10	25	20	35	25	45	45	70	80	105
100	120	10	25	20	35	25	50	50	80	95	120
120	140	15	30	25	40	30	60	60	90	105	135
140	160	15	35	30	45	35	65	65	100	115	150
160	180	15	35	30	45	35	75	75	110	125	165
180	200	20	40	30	50	40	80	80	120	140	180
200	225	20	45	35	55	45	90	90	135	155	200
225	250	25	50	40	65	50	100	100	150	170	215
250	280	25	55	40	65	55	110	110	165	185	240
280	315	30	60	45	75	60	120	120	180	205	265
315	355	30	65	45	75	65	135	135	200	225	295
355	400	35	75	50	90	75	150	150	225	255	330
400	450	45	85	60	100	85	170	170	255	285	370
450	500	50	95	70	115	95	190	190	285	315	410

① The code for normal internal clearance is "NA". Ex: N1006HSKNA

② Internal clearances C9NA, C0NA and C1NA apply to bearings of JIS class 5 or higher.

■ Interchangeable radial internal clearance (cylindrical bore)

Table 10.6

Unit:  $\mu\text{m}$

Nominal bore diameter $d$ mm		C2		CN (Normal)		C3	
over	incl.	min	max	min	max	min	max
24	30	0	25	20	45	35	60
30	40	5	30	25	50	45	70
40	50	5	35	30	60	50	80
50	65	10	40	40	70	60	90
65	80	10	45	40	75	65	100
80	100	15	50	50	85	75	110
100	120	15	55	50	90	85	125
120	140	15	60	60	105	100	145
140	160	20	70	70	120	115	165
160	180	25	75	75	125	120	170
180	200	35	90	90	145	140	195
200	225	45	105	105	165	160	220
225	250	45	110	110	175	170	235
250	280	55	125	125	195	190	260
280	315	55	130	130	205	200	275
315	355	65	145	145	225	225	305
355	400	100	190	190	280	280	370
400	450	110	210	210	310	310	410
450	500	110	220	220	330	330	440

■ Adjustment of clearance in tapered bore bearings

Mounted internal clearance of a tapered bore bearing can be adjusted by controlling the drive-up of the tapered bore onto the shaft. Two types of adjusting methods are available: repeated adjustment of spacer width and adjustment with using a mounted internal clearance gauge. The clearance gauge is convenient for mass-production. Refer to "6. Handling of Bearings, ⑦ Clearance adjustment for cylindrical roller bearing, measurement with mounted internal clearance gauge" in the Technical Data section.

⑦ Recommended fit of high-precision cylindrical roller bearings

In order to maintain the high precision of the bearing at  $d_{m11}$  values less than  $0.75 \times 10^6$  the fits listed in **Tables 10.7 and 10.8** are recommended ( $d_{m11}$ : pitch circle diameter across rolling elements [mm] multiplied by speed [ $\text{min}^{-1}$ ]).

When the  $d_{m11}$  value is larger than  $0.75 \times 10^6$  ( $d_{m11}$  value  $\geq 0.75 \times 10^6$ ), consult NTN Engineering about the recommended fit. Expansion of the inner ring due to centrifugal force must be considered when determining shaft fit.

**Table 10.7 Fit with shaft**

Unit:  $\mu\text{m}$

Nominal bore diameter $d$ mm		Fit between inner ring and shaft
over	incl.	
18	30	0~ 4T
30	50	0~ 5T
50	80	1T~ 6T
80	120	1T~ 6T
120	180	2T~ 8T
180	250	2T~ 8T
250	315	3T~10T
315	400	4T~11T

Note 1: Target the median value.

T: Tight (Interference) fit

Not applicable to tapered bore bearings

**Table 10.8 Fit with housing**

Unit:  $\mu\text{m}$

Nominal bore diameter $D$ mm		Fit between outer ring and housing
over	incl.	
30	50	0~3T
50	80	0~4T
80	120	0~4T
120	150	0~5T
150	180	0~5T
180	250	0~6T
250	315	0~7T
315	400	0~8T
400	500	0~9T

Note 1: Target the median value.

T: Tight (Interference) fit

■ Fit of tapered bore bearings

When fitting a tapered bore bearing onto a shaft, carefully and thoroughly adjust the fit of the tapered bore to the shaft to maintain high precision of the bearing.

For details of taper angle adjustment refer to "6. Handling of Bearings, ⑧ Cylindrical roller bearing and main spindle taper angle" in the Technical Data section.

## ⑧ Recommended lubrication specifications

Cylindrical roller bearings are usually used with grease lubrication or air-oil lubrication. Recommended lubrication specifications are described below.

### ■ Grease lubrication

#### ● Recommended brand of grease

Refer to "7. Lubrication of Bearings, ① Grease lubrication" in the Technical Data section.

#### ● Recommended grease fill

10% of the internal free space shown in the dimension tables

#### ● Recommended grease packing method

Refer to "6. Handling of Bearings, ① Cleaning and filling with grease" in the Technical Data section.

### ■ Air-oil lubrication

#### ● Recommended location of nozzle

Refer to "7. Lubrication of Bearings, ② Air-oil lubrication" in the Technical Data section.

#### ● Recommended specifications of nozzle

Nozzle bore diameter.: From 1 to 1.5 mm  
Number of nozzles: One nozzle for each bearing,  
depth of nozzle bore should be four to six times the  
nozzle diameter.

#### ● Recommended specifications of air-oil

Oil type: Spindle oil  
Viscosity grade: ISO VG from 10 to 32 (32 is

Table. 10.9 Air and oil amount

Bearing type	$d_{min}$ value ( $\times 10^3$ )		Oil amount per shot $\text{cm}^3$	Lubrication interval min	Oil consumption $\text{cm}^3/\text{h}$	Recommended air consumption * $\text{N} \ell / \text{min}$
	Over	Incl.				
NN30	~ 1.0		0.02	8	0.15	30~40
NN30HS	1.0 ~ 1.5			5	0.24	
N10HS	1.5 ~ 2.3			5	0.24	
N10HSRT6						
NN30HST6	~ 1.7			15	0.08	
NN30HSRT6						
N10HSL	~ 2.3			10	0.12	20~40

\*  $\text{N} \ell / \text{min}$  (Normal liter/minute) ...  $\text{N} \ell$  means the volume of air at 0°C and 1 atmosphere.

9 **ULTAGE** Ultra high speed double row cylindrical roller bearings NN30HSRT6 type

NN30HSRT6 ultra high speed double row cylindrical roller bearings have higher operating speeds with the same level of rigidity and capacity as the conventional series.

**Features**

1. Optimized internal design to realize high speed and low temperature rise.
2. Molded PEEK cage is used for high speed under grease & air-oil lubrication and grease life.

**Bearing design**

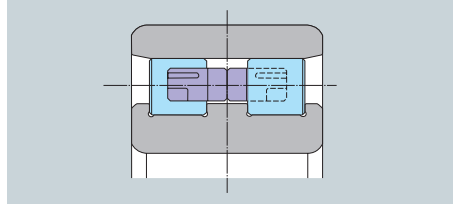
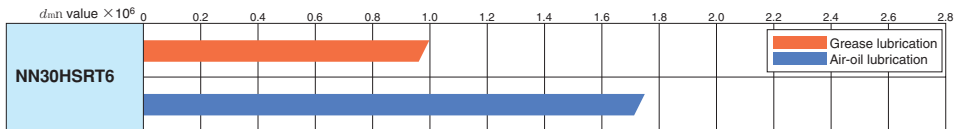


Fig. 10.4 NN30HSRT6 type

**Permissible speed range**



(Notes) Permissible speed of each bearing ( $d_{min}$  value) varies depending on the specifications of the machine for which the bearing is used (motor drive system, cooling system, and construction around the bearing). Consider the optimal choice referring to the above guideline and contact NTN.

**Cage design**

Cage is made of PEEK which is very light and strong. (Photo 10.1)

By using a proven cage design made of PEEK material, less deformation of the cage is seen due to centrifugal force. As a result, the high speed operation of the bearing is improved. The grease life of the bearing is improved by including a pocket for grease in the cage.



Photo 10.1 PEEK cage

**High speed test**

$d_{m11}$  value of  $1.0 \times 10^6$  under grease lubrication and  $1.75 \times 10^6$  under air-oil lubrication are realized by the optimized internal design. (Fig 10.5, 10.6)

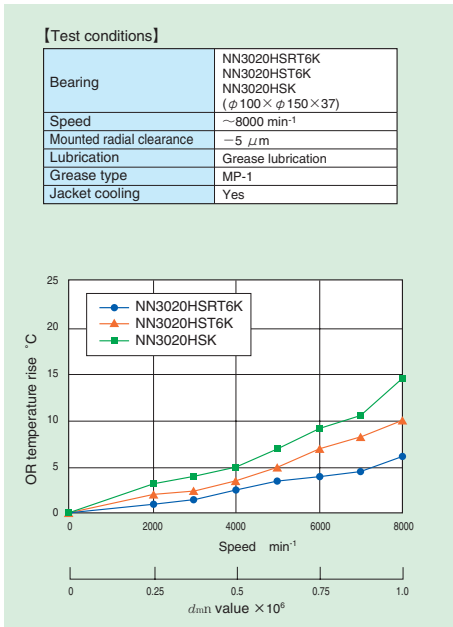


Fig. 10.5 Comparison of temperature rise (grease)

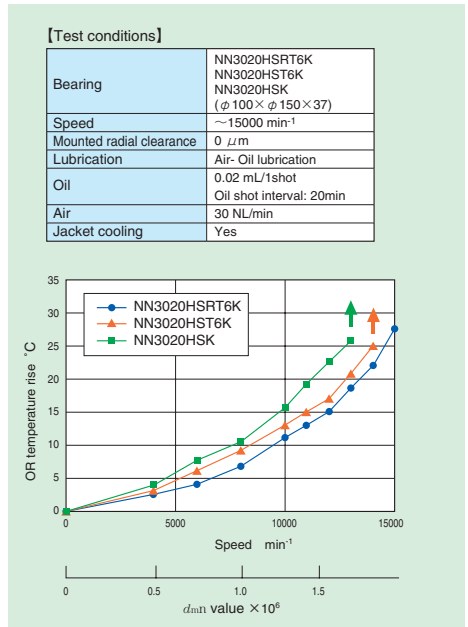


Fig. 10.6 Comparison of temperature rise (air- oil)

**Grease life**

Over 13800 hours continuous operation under grease lubrication is realized by the improved cage design at  $d_{m11}$  value of  $1.0 \times 10^6$ . (Fig. 10.7)

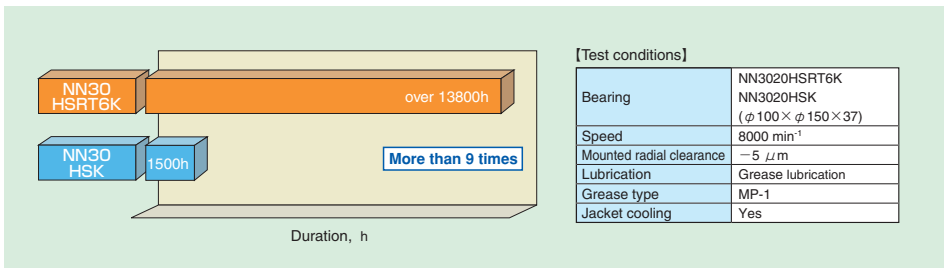


Fig. 10.7 Comparison of grease life

10 **ULTAGE** Ultra high-speed single row cylindrical roller bearings N10HSRT6 type

N10HSRT6 type cylindrical roller bearings have been designed for high-speed operation.

**Features**

1. Optimized internal design allows high speed operation and limits temperature increase.
2. Special resin cage is suitable for high-speed operation.

**Bearing specification**

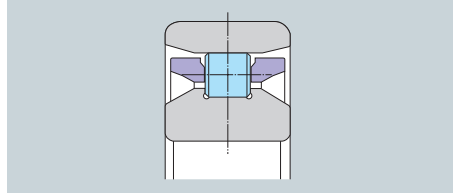
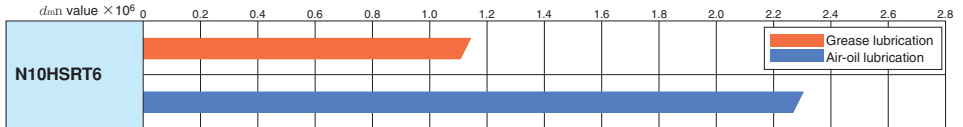


Fig. 10.8 N10HSRT6 type

**Permissible speed range**



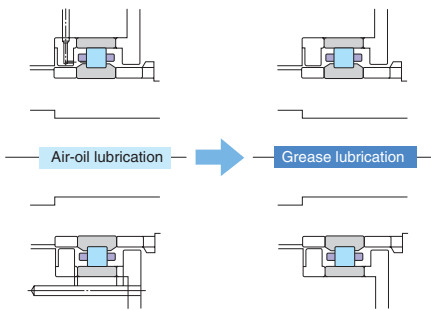
(Notes) Permissible speed of each bearing ( $d_{mdn}$  value) varies depending on the specifications of the machine for which the bearing is used (motor drive system, cooling system, and construction around the bearing). Consider the optimal choice referring to the above guideline and contact NTN.

**Simplified main spindle configuration / adoption of simplified lubrication system**

Due to an optimized internal structure, the N10HSR type bearings can reliably run at a higher speed with grease lubrication. The grease lubrication system greatly contributes to reduction in pollution of the surrounding environments by virtually eliminating oil mist (Fig. 10.9).

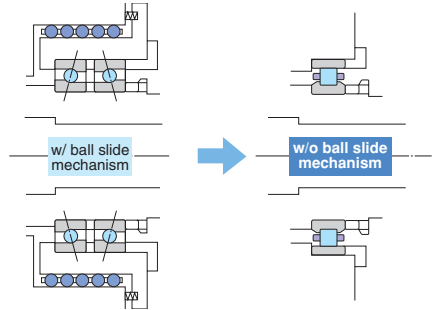
**Simplified main spindle configuration / simplified main spindle rear structure**

N10HSR (N10HSL) type high-speed cylindrical roller bearings can replace angular contact ball bearings on the rear side of the main spindle. This arrangement decreases the number of bearing rows (two rows to one row) and eliminates the ball slide mechanism, greatly contributing to simplification of the rear structure (Fig. 10.10).



Capable of replacing air-oil lubricated bearings up to  $d_{mdn}$  value of  $1.15 \times 10^6$ .

Fig. 10.9 Modification of lubrication system



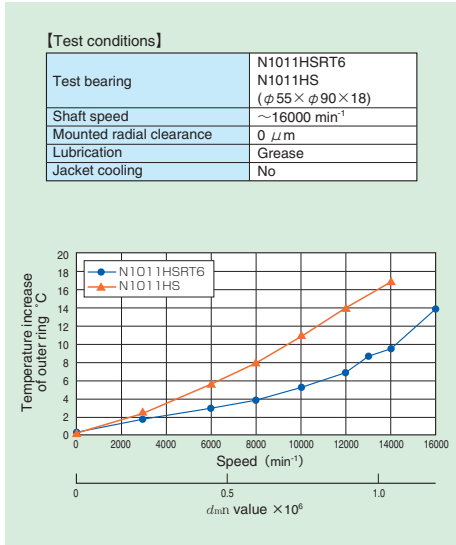
Capable of replacing angular contact ball bearings up to  $d_{mdn}$  value of  $2.3 \times 10^6$  [air-oil lubrication] or  $1.15 \times 10^6$  [grease lubrication].

Fig. 10.10 Simplified main spindle rear structure

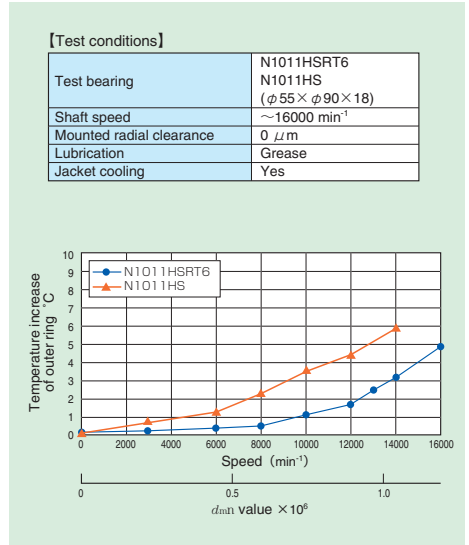


**High-speed operation test with grease lubrication**

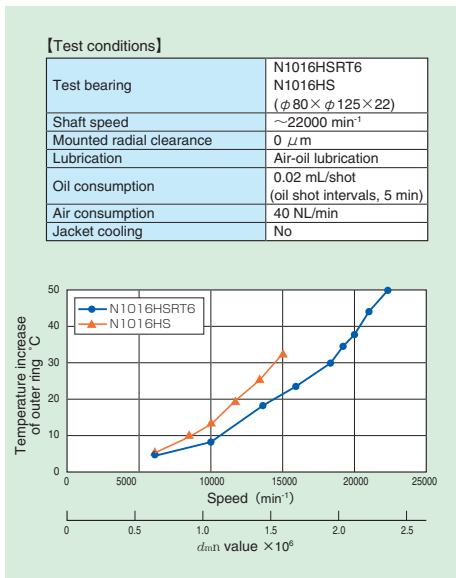
Due to an optimized internal design, the N10HSR type is capable of high-speed operation with  $d_{min}$  value of  $1.15 \times 10^6$  [grease lubrication] or  $2.3 \times 10^6$  [air-oil lubrication] (Figs. 10.11, 10.12, 10.13, 10.14).



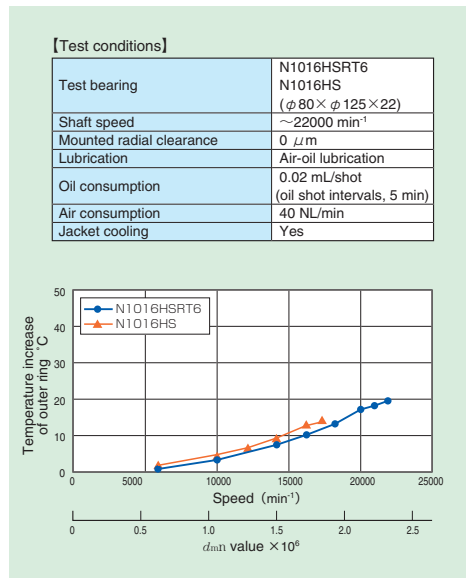
**Fig. 10.11 High-speed test results (grease lubrication without outer case cooling)**



**Fig. 10.12 High-speed test results (grease lubrication with outer case cooling)**



**Fig. 10.13 High-speed test results (air-oil lubrication without jacket cooling)**



**Fig. 10.14 High-speed test results (air-oil lubrication with jacket cooling)**

11 **ULTAGE** Eco-friendly air-oil lubricated cylindrical roller bearings N10HSLT6 type

The eco-friendly air-oil lubricated N10HSLT6 type was developed by applying NTN's unique eco-conscious technology to the proven N10HSRT6 type bearing design. The N10HSLT6 type boasts limited emission of oil mist and reduced air and oil consumption. This improves operating environments, saves energy while allowing higher-speed machining operation.

**Features**

- Optimized internal design allows high speed operation and limits temperature increase.
- Adoption of the eco-friendly nozzle design has led to:
  - Lower noise level (up to 7 dBA)
  - 50% reduction in air consumption
  - 50% reduction in oil consumption.

**Bearing specification**

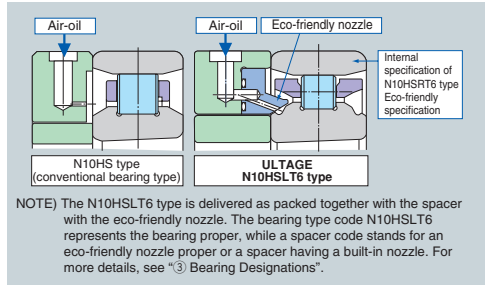
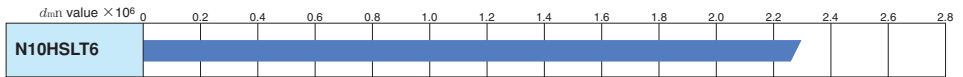


Fig. 10.15 N10HSLT6 type

**Permissible speed range**



Notes) Permissible speed of each bearing ( $d_{mn}$  value) varies depending on the specifications of the machine for which the bearing is used (motor drive system, cooling system, and construction around the bearing). Consider the optimal choice referring to the above guideline and contact NTN.

**High-speed running test**

Even with decreased air consumption and oil consumption, the N10HSL type bearings can reliably operate at high speed of  $d_{mn}$   $2.3 \times 10^6$  (Fig. 10.16, 10.17).

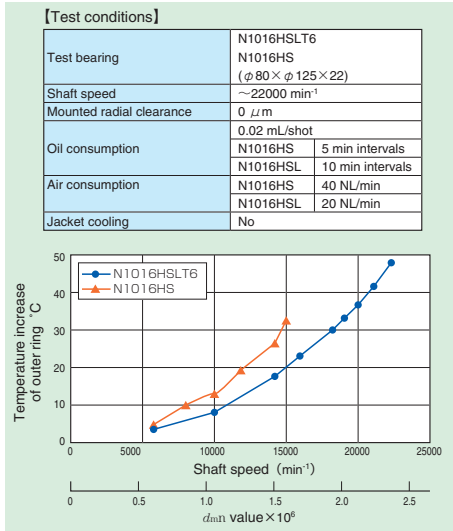


Fig. 10.16 High-speed test results (without Jacket cooling)

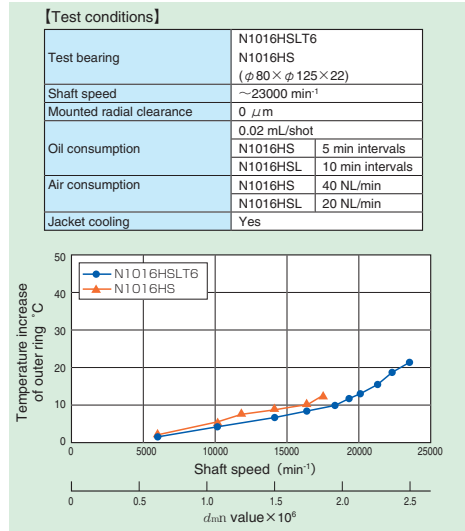


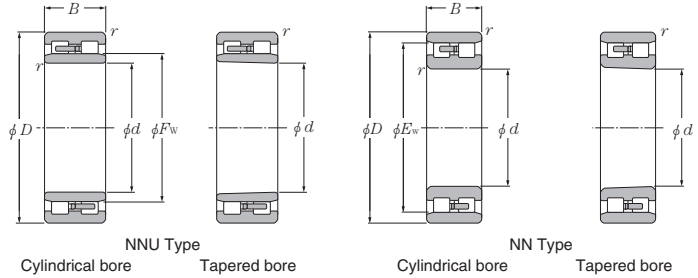
Fig. 10.17 High-speed test results (with Jacket cooling)



## 12 Dimension tables for double row cylindrical roller bearings

### ULTAGE Double row cylindrical roller bearings

d 25~95mm

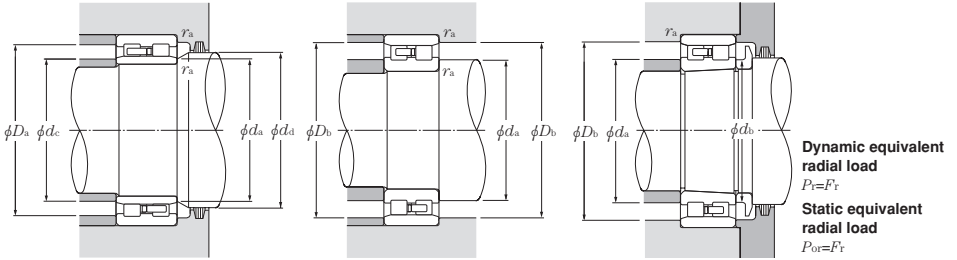


Part number				Boundary dimensions				Basic load ratings				Limiting speeds	
NNU Type		NN Type		mm				kN		kgf		min <sup>-1</sup>	
cylindrical bore	tapered bore <sup>①</sup>	cylindrical bore	tapered bore <sup>①</sup>	d	D	B	r <sub>8 min</sub> <sup>②</sup>	C <sub>r</sub>	C <sub>or</sub>	C <sub>r</sub>	C <sub>or</sub>	grease lubrication	oil lubrication
—	—	NN3005	NN3005K	25	47	16	0.6	25.8	30.0	2 630	3 050	19 300	23 400
—	—	NN3005HS	NN3005HSK	25	47	16	0.6	25.8	30.0	2 630	3 050	22 600	31 100
—	—	NN3006	NN3006K	30	55	19	1	31.0	37.0	3 150	3 800	16 300	19 800
—	—	NN3006HS	NN3006HSK	30	55	19	1	31.0	37.0	3 150	3 800	19 100	26 300
—	—	NN3007	NN3007K	35	62	20	1	38.0	47.5	3 850	4 850	14 300	17 300
—	—	NN3007HS	NN3007HSK	35	62	20	1	38.0	47.5	3 850	4 850	16 700	23 100
—	—	NN3008	NN3008K	40	68	21	1	43.5	55.5	4 400	5 650	12 800	15 600
—	—	NN3008HS	NN3008HSK	40	68	21	1	43.5	55.5	4 400	5 650	15 000	20 700
—	—	NN3009	NN3009K	45	75	23	1	52.0	68.5	5 300	7 000	11 600	14 000
—	—	NN3009HS	NN3009HSK	45	75	23	1	52.0	68.5	5 300	7 000	13 600	18 700
—	—	NN3010	NN3010K	50	80	23	1	53.0	72.5	5 400	7 400	10 700	13 000
—	—	NN3010HS	NN3010HSK	50	80	23	1	53.0	72.5	5 400	7 400	12 500	17 300
—	—	NN3011	NN3011K	55	90	26	1.1	69.5	96.5	7 050	9 850	9 600	11 600
—	—	NN3011HS	NN3011HSK	55	90	26	1.1	69.5	96.5	7 050	9 850	11 200	15 500
—	—	NN3012	NN3012K	60	95	26	1.1	71.0	102	7 250	10 400	9 000	10 900
—	—	NN3012HS	NN3012HSK	60	95	26	1.1	71.0	102	7 250	10 400	10 500	14 500
—	—	NN3013	NN3013K	65	100	26	1.1	75.0	111	7 650	11 400	8 400	10 200
—	—	NN3013HST6	NN3013HST6K	65	100	26	1.1	72.5	107	7 400	10 900	9 900	13 600
—	—	NN3013HSRT6	NN3013HSRT6K	65	100	26	1.1	72.5	107	7 400	10 900	12 100	21 200
—	—	NN3014	NN3014K	70	110	30	1.1	94.5	143	9 650	14 600	7 700	9 300
—	—	NN3014HST6	NN3014HST6K	70	110	30	1.1	92.0	137	9 350	14 000	9 000	12 400
—	—	NN3014HSRT6	NN3014HSRT6K	70	110	30	1.1	92.0	137	9 350	14 000	11 000	19 300
—	—	NN3015	NN3015K	75	115	30	1.1	96.5	149	9 850	15 200	7 300	8 900
—	—	NN3015HST6	NN3015HST6K	75	115	30	1.1	96.5	149	9 850	15 200	8 500	11 800
—	—	NN3015HSRT6	NN3015HSRT6K	75	115	30	1.1	96.5	149	9 850	15 200	10 400	18 300
—	—	NN3016	NN3016K	80	125	34	1.1	116	179	11 800	18 200	6 800	8 300
—	—	NN3016HST6	NN3016HST6K	80	125	34	1.1	112	172	11 500	17 500	8 000	11 000
—	—	NN3016HSRT6	NN3016HSRT6K	80	125	34	1.1	112	172	11 500	17 500	9 700	17 100
—	—	NN3017	NN3017K	85	130	34	1.1	122	194	12 400	19 800	6 500	7 900
—	—	NN3017HST6	NN3017HST6K	85	130	34	1.1	118	187	12 100	19 100	7 600	10 500
—	—	NN3017HSRT6	NN3017HSRT6K	85	130	34	1.1	118	187	12 100	19 100	9 300	16 300
—	—	NN3018	NN3018K	90	140	37	1.5	143	228	14 600	23 200	6 000	7 300
—	—	NN3018HST6	NN3018HST6K	90	140	37	1.5	143	228	14 600	23 200	7 100	9 700
—	—	NN3018HSRT6	NN3018HSRT6K	90	140	37	1.5	143	228	14 600	23 200	8 600	15 200
—	—	NN3019	NN3019K	95	145	37	1.5	146	238	14 900	24 200	5 800	7 000

① A bearing number with suffix K indicates a tapered-bore bearing (taper ratio 1/12).

② Minimum allowable value for corner radius dimension r.

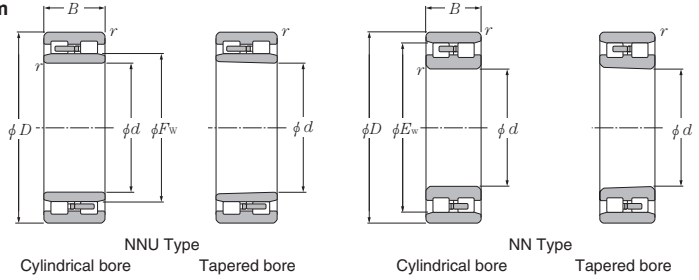
A part number containing a suffix T6 means an ULTAGE Series.



Dimensions		Abutment and fillet dimensions							Mass				Internal free space	
mm		mm							kg (approx.)				cm <sup>3</sup>	
$F_w$	$E_w$	$d_a$ min	$d_b$ min	$d_c$ max	$d_d$ min	$D_a$ max	$D_b$ max	$r_{as}$ max	cylindrical bore	tapered bore	NN Type cylindrical bore	NN Type tapered bore	NN Type	
—	41.3	29	30	—	—	—	43	42	0.6	—	—	0.124	0.121	3.72
—	41.3	29	30	—	—	—	43	42	0.6	—	—	0.124	0.121	3.72
—	48.5	35	36.5	—	—	—	50	49	1	—	—	0.199	0.193	6.38
—	48.5	35	36.5	—	—	—	50	49	1	—	—	0.199	0.193	6.38
—	55	40	41.5	—	—	—	57	56	1	—	—	0.242	0.235	8.09
—	55	40	41.5	—	—	—	57	56	1	—	—	0.242	0.235	8.09
—	61	45	47	—	—	—	63	62	1	—	—	0.312	0.303	9.68
—	61	45	47	—	—	—	63	62	1	—	—	0.312	0.303	9.68
—	67.5	50	52	—	—	—	70	69	1	—	—	0.405	0.393	13.3
—	67.5	50	52	—	—	—	70	69	1	—	—	0.405	0.393	13.3
—	72.5	55	57	—	—	—	75	74	1	—	—	0.433	0.419	14.6
—	72.5	55	57	—	—	—	75	74	1	—	—	0.433	0.419	14.6
—	81	61.5	63.5	—	—	—	83.5	82	1	—	—	0.651	0.631	20.5
—	81	61.5	63.5	—	—	—	83.5	82	1	—	—	0.651	0.631	20.5
—	86.1	66.5	68.5	—	—	—	88.5	87	1	—	—	0.704	0.683	21.1
—	86.1	66.5	68.5	—	—	—	88.5	87	1	—	—	0.704	0.683	21.1
—	91	71.5	73.5	—	—	—	93.5	92	1	—	—	0.76	0.74	22.2
—	91	71.5	73.5	—	—	—	93.5	92	1	—	—	0.69	0.66	21.4
—	91	71.5	73.5	—	—	—	93.5	92	1	—	—	0.69	0.66	21.4
—	100	76.5	79	—	—	—	103.5	101	1	—	—	1.04	1.01	33.0
—	100	76.5	79	—	—	—	103.5	101	1	—	—	0.99	0.96	30.4
—	100	76.5	79	—	—	—	103.5	101	1	—	—	0.99	0.96	30.4
—	105	81.5	84	—	—	—	108.5	106	1	—	—	1.14	1.11	35.0
—	105	81.5	84	—	—	—	108.5	106	1	—	—	1.05	1.02	31.2
—	105	81.5	84	—	—	—	108.5	106	1	—	—	1.05	1.02	31.2
—	113	86.5	89.5	—	—	—	118.5	114	1	—	—	1.52	1.47	45.0
—	113	86.5	89.5	—	—	—	118.5	114	1	—	—	1.43	1.38	43.0
—	113	86.5	89.5	—	—	—	118.5	114	1	—	—	1.43	1.38	43.0
—	118	91.5	84.5	—	—	—	123.5	119	1	—	—	1.61	1.56	48.8
—	118	91.5	84.5	—	—	—	123.5	119	1	—	—	1.51	1.46	44.4
—	118	91.5	84.5	—	—	—	123.5	119	1	—	—	1.51	1.46	44.4
—	127	98	101	—	—	—	132	129	1.5	—	—	2.07	2.01	64.1
—	127	98	101	—	—	—	132	129	1.5	—	—	1.97	1.91	57.6
—	127	98	101	—	—	—	132	129	1.5	—	—	1.97	1.91	57.6
—	132	103	106	—	—	—	137	134	1.5	—	—	2.17	2.10	67.0

## ULTAGE Double row cylindrical roller bearings

$d$  100~190mm

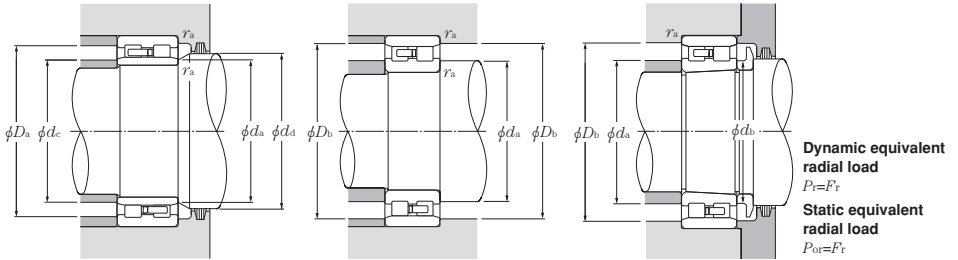


Part number				Boundary dimensions				Basic load ratings				Limiting speeds	
NNU Type		NN Type		mm				kN		kgf		min <sup>-1</sup>	
cylindrical bore	tapered bore <sup>①</sup>	cylindrical bore	tapered bore <sup>①</sup>	$d$	$D$	$B$	$r$ $r_8$ min <sup>②</sup>	$C_r$	$C_{or}$	$C_r$	$C_{or}$	grease lubrication	oil lubrication
NNU4920	NNU4920K	NN4920	NN4920K	100	140	40	1.1	131	260	13 300	26 500	6 000	7 200
—	—	NN3020	NN3020K	100	150	37	1.5	153	256	15 600	26 100	5 600	6 700
—	—	NN3020HST6	NN3020HST6K	100	150	37	1.5	149	247	15 200	25 200	6 500	9 000
—	—	NN3020HSRT6	NN3020HSRT6K	100	150	37	1.5	149	247	15 200	25 200	8 000	14 000
NNU4921	NNU4921K	NN4921	NN4921K	105	145	40	1.1	133	268	13 500	27 400	5 700	6 900
—	—	NN3021	NN3021K	105	160	41	2	198	320	20 200	33 000	5 300	6 400
—	—	NN3021HST6	NN3021HST6K	105	160	41	2	198	320	20 200	33 000	6 200	8 500
—	—	NN3021HSRT6	NN3021HSRT6K	105	160	41	2	198	320	20 200	33 000	7 100	11 300
NNU4922	NNU4922K	NN4922	NN4922K	110	150	40	1.1	137	284	14 000	28 900	5 500	6 600
—	—	NN3022	NN3022K	110	170	45	2	229	375	23 300	38 000	5 000	6 000
—	—	NN3022HST6	NN3022HST6K	110	170	45	2	229	375	23 300	38 000	5 800	8 000
—	—	NN3022HSRT6	NN3022HSRT6K	110	170	45	2	229	375	23 300	38 000	6 700	10 600
NNU4924	NNU4924K	NN4924	NN4924K	120	165	45	1.1	183	360	18 700	37 000	5 000	6 000
—	—	NN3024	NN3024K	120	180	46	2	233	390	23 700	40 000	4 600	5 600
—	—	NN3024HST6	NN3024HST6K	120	180	46	2	226	380	23 100	38 500	5 400	7 500
—	—	NN3024HSRT6	NN3024HSRT6K	120	180	46	2	226	380	23 100	38 500	6 200	9 900
NNU4926	NNU4926K	NN4926	NN4926K	130	180	50	1.5	220	440	22 400	45 000	4 600	5 500
—	—	NN3026	NN3026K	130	200	52	2	284	475	29 000	48 500	4 200	5 100
—	—	NN3026HST6	NN3026HST6K	130	200	52	2	284	475	29 000	48 500	4 900	6 800
—	—	NN3026HSRT6	NN3026HSRT6K	130	200	52	2	284	475	29 000	48 500	5 700	9 000
NNU4928	NNU4928K	NN4928	NN4928K	140	190	50	1.5	227	470	23 100	48 000	4 300	5 200
—	—	NN3028	NN3028K	140	210	53	2	298	515	30 500	52 500	4 000	4 800
—	—	NN3028HST6	NN3028HST6K	140	210	53	2	298	515	30 500	52 500	4 700	6 400
NNU4930	NNU4930K	NN4930	NN4930K	150	210	60	2	345	690	35 000	70 500	3 900	4 800
—	—	NN3030	NN3030K	150	225	56	2.1	335	585	34 000	60 000	3 700	4 500
—	—	NN3030HS	NN3030HSK	150	225	56	2.1	335	585	34 000	60 000	4 300	6 000
NNU4932	NNU4932K	NN4932	NN4932K	160	220	60	2	355	740	36 500	75 500	3 700	4 500
—	—	NN3032	NN3032K	160	240	60	2.1	375	660	38 000	67 500	3 500	4 200
—	—	NN3032HS	NN3032HSK	160	240	60	2.1	375	660	38 000	67 500	4 100	5 600
NNU4934	NNU4934K	NN4934	NN4934K	170	230	60	2	360	765	37 000	78 000	3 600	4 300
—	—	NN3034	NN3034K	170	260	67	2.1	440	775	45 000	79 000	3 200	3 900
NNU4936	NNU4936K	NN4936	NN4936K	180	250	69	2	460	965	46 500	98 500	3 200	3 800
—	—	NN3036	NN3036K	180	280	74	2.1	565	995	57 500	102 000	3 000	3 600
NNU4938	NNU4938K	NN4938	NN4938K	190	260	69	2	475	1 030	48 500	105 000	3 000	3 600
—	—	NN3038	NN3038K	190	290	75	2.1	580	1 040	59 000	106 000	2 800	3 300

① A bearing number with suffix K indicates a tapered-bore bearing (taper ratio 1/12).

② Minimum allowable value for corner radius dimension  $r$ .

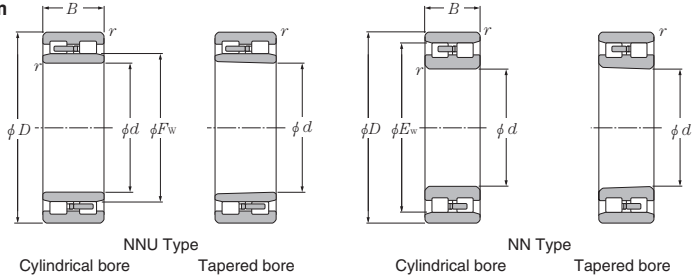
A part number containing a suffix T6 means an ULTAGE Series



Dimensions		Abutment and fillet dimensions							Mass kg (approx.)				Internal free space	
mm		mm							NNU Type		NN Type		cm <sup>3</sup>	
<i>F<sub>w</sub></i>	<i>E<sub>w</sub></i>	<i>d<sub>a</sub></i> min	<i>d<sub>b</sub></i> min	<i>d<sub>c</sub></i> max	<i>d<sub>d</sub></i> min	<i>D<sub>a</sub></i> max	<i>D<sub>b</sub></i> max	<i>r<sub>as</sub></i> max	cylindrical bore	tapered bore	cylindrical bore	tapered bore	NN Type	
113	129	106.5	110	111	115	133.5	133.5	131	1	1.83	1.75	1.75	1.67	49.8
—	137	108	111	—	—	—	142	139	1.5	—	—	2.26	2.19	67.5
—	137	108	111	—	—	—	142	139	1.5	—	—	2.14	2.07	61.6
—	137	108	111	—	—	—	142	139	1.5	—	—	2.14	2.07	61.6
118	134	111.5	115	116	120	138.5	138.5	136	1	1.91	1.82	1.82	1.73	50.2
—	146	114	117	—	—	—	151	148	2	—	—	2.89	2.80	91.9
—	146	114	117	—	—	—	151	148	2	—	—	2.75	2.66	82.7
—	146	114	117	—	—	—	151	148	2	—	—	2.75	2.66	82.7
123	139	116.5	120	121	125	143.5	143.5	141	1	1.99	1.90	1.90	1.81	53.9
—	155	119	123	—	—	—	161	157	2	—	—	3.69	3.56	115
—	155	119	123	—	—	—	161	157	2	—	—	3.50	3.37	103
—	155	119	123	—	—	—	161	157	2	—	—	3.50	3.37	103
134.5	154.5	126.5	130	133	137	158.5	158.5	156.5	1	2.75	2.62	2.63	2.51	82.5
—	165	129	133	—	—	—	171	167	2	—	—	3.98	3.83	130
—	165	129	133	—	—	—	171	167	2	—	—	3.76	3.61	117
—	165	129	133	—	—	—	171	167	2	—	—	3.76	3.61	117
146	168	138	142	144	148	172	172	170	1.5	3.69	3.52	3.52	3.35	112
—	182	139	143	—	—	—	191	183	2	—	—	5.92	5.71	182
—	182	139	143	—	—	—	191	183	2	—	—	5.55	5.34	164
—	182	139	143	—	—	—	191	183	2	—	—	5.55	5.34	164
156	178	148	152	154	158	182	182	180	1.5	3.94	3.76	3.76	3.58	117
—	192	149	153	—	—	—	201	194	2	—	—	6.44	6.21	199
—	192	149	153	—	—	—	201	194	2	—	—	6.11	5.91	176
168.5	196.5	159	164	166	171	201	201	198.5	2	6.18	5.90	5.90	5.62	192
—	206	161	166	—	—	—	214	208	2	—	—	7.81	7.53	237
—	206	161	166	—	—	—	214	208	2	—	—	7.81	7.53	237
178.5	206.5	169	174	176	182	211	211	208.5	2	6.53	6.23	6.24	5.94	199
—	219	171	176	—	—	—	229	221	2	—	—	8.92	8.59	287
—	219	171	176	—	—	—	229	221	2	—	—	8.92	8.59	287
188.5	216.5	179	184	186	192	221	221	218.5	2	6.87	6.55	6.56	6.24	212
—	236	181	187	—	—	—	249	238	2	—	—	12.6	12.2	379
202	234	189	195	199	205	241	241	236	2	9.90	9.46	9.45	9.01	299
—	255	191	197	—	—	—	269	257	2	—	—	16.6	16.0	478
212	244	199	205	209	215	251	251	246	2	10.4	9.94	9.93	9.47	303
—	265	201	207	—	—	—	279	267	2	—	—	18.0	17.4	504

## Double row cylindrical roller bearings

d 200~500mm

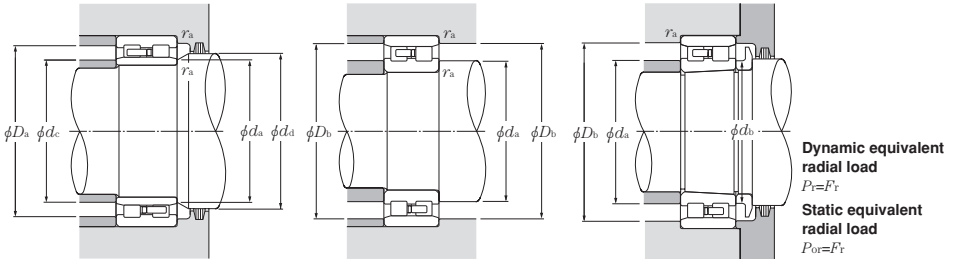


Part number				Boundary dimensions				Basic load ratings				Limiting speeds	
NNU Type		NN Type		mm				kN		kgf		min <sup>-1</sup>	
cylindrical bore	tapered bore <sup>①</sup>	cylindrical bore	tapered bore <sup>①</sup>	d	D	B	r <sub>s</sub> min <sup>②</sup>	C <sub>r</sub>	C <sub>or</sub>	C <sub>r</sub>	C <sub>or</sub>	grease lubrication	oil lubrication
NNU4940	NNU4940K	NN4940	NN4940K	200	280	80	2.1	555	1 180	56 500	120 000	2 900	3 500
—	—	NN3040	NN3040K	200	310	82	2.1	655	1 170	66 500	119 000	2 600	3 100
NNU4944	NNU4944K	NN4944	NN4944K	220	300	80	2.1	585	1 300	59 500	132 000	2 600	3 100
—	—	NN3044	NN3044K	220	340	90	3	815	1 480	83 000	151 000	2 300	2 800
NNU4948	NNU4948K	NN4948	NN4948K	240	320	80	2.1	610	1 410	62 500	144 000	2 300	2 800
—	—	NN3048	NN3048K	240	360	92	3	855	1 600	87 000	163 000	2 200	2 600
NNU4952	NNU4952K	NN4952	NN4952K	260	360	100	2.1	900	2 070	92 000	211 000	2 200	2 600
—	—	NN3052	NN3052K	260	400	104	4	1 060	1 990	108 000	203 000	2 100	2 500
NNU4956	NNU4956K	NN4956	NN4956K	280	380	100	2.1	925	2 200	94 500	224 000	1 900	2 300
—	—	NN3056	NN3056K	280	420	106	4	1 080	2 080	110 000	212 000	1 800	2 100
NNU4960	NNU4960K	NN4960	NN4960K	300	420	118	3	1 200	2 800	122 000	285 000	1 800	2 100
—	—	NN3060	NN3060K	300	460	118	4	1 330	2 560	135 000	261 000	1 600	2 000
NNU4964	NNU4964K	NN4964	NN4964K	320	440	118	3	1 240	2 970	126 000	305 000	1 600	2 000
—	—	NN3064	NN3064K	320	480	121	4	1 350	2 670	138 000	272 000	1 500	1 800
NNU4968	NNU4968K	—	—	340	460	118	3	1 270	3 150	130 000	320 000	1 500	1 800
—	—	NN3068	NN3068K	340	520	133	5	1 620	3 200	165 000	325 000	1 500	1 800
NNU4972	NNU4972K	—	—	360	480	118	3	1 290	3 250	131 000	330 000	1 500	1 800
—	—	NN3072	NN3072K	360	540	134	5	1 650	3 300	169 000	340 000	1 400	1 600
NNU4976	NNU4976K	—	—	380	520	140	4	1 630	4 050	167 000	415 000	1 400	1 600
—	—	NN3076	NN3076K	380	560	135	5	1 690	3 450	172 000	355 000	1 300	1 500
NNU4980	NNU4980K	—	—	400	540	140	4	1 690	4 300	172 000	435 000	1 300	1 500
—	—	NN3080	NN3080K	400	600	148	5	2 040	4 150	208 000	420 000	1 200	1 400
NNU4984	NNU4984K	—	—	420	560	140	4	1 740	4 500	177 000	460 000	1 200	1 500
—	—	NN3084	NN3084K	420	620	150	5	2 080	4 300	212 000	440 000	1 100	1 400
NNU4988	NNU4988K	—	—	440	600	160	4	2 150	5 550	219 000	565 000	1 100	1 400
—	—	NN3088	NN3088K	440	650	157	6	2 420	5 100	247 000	520 000	1 100	1 300
NNU4992	NNU4992K	—	—	460	620	160	4	2 220	5 850	226 000	595 000	1 100	1 300
—	—	NN3092	NN3092K	460	680	163	6	2 550	5 350	260 000	545 000	1 000	1 200
NNU4996	NNU4996K	—	—	480	650	170	5	2 280	5 900	233 000	600 000	1 000	1 200
NNU49/500	NNU49/500K	—	—	500	670	170	5	2 360	6 200	240 000	635 000	1 000	1 200

① A bearing number with suffix K indicates a tapered-bore bearing (taper ratio 1/12).

② Minimum allowable value for corner radius dimension r.

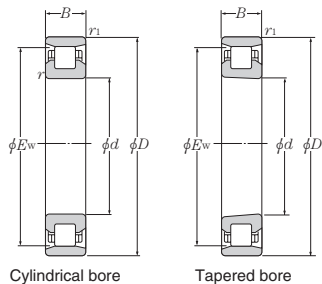




Dimensions		Abutment and fillet dimensions								Mass kg (approx.)				Internal free space
mm		mm								NNU Type		NN Type		cm <sup>3</sup>
$F_w$	$E_w$	$d_a$ min	$d_b$ min	$d_c$ max	$d_d$ min	$D_a$ max	$D_b$ max	$r_{as}$ max	cylindrical bore	tapered bore	cylindrical bore	tapered bore	NN Type	
225	261	211	218	222	228	269	269	264	2	14.7	14.0	14.0	13.3	437
—	282	211	218	—	—	—	299	285	2	—	—	21.6	20.8	649
245	281	231	238	242	248	289	289	284	2	15.9	15.2	15.2	14.5	485
—	310	233	240	—	—	—	327	313	2.5	—	—	29.3	28.2	877
265	301	251	258	262	269	309	309	304	2	17.2	16.4	16.4	15.6	518
—	330	253	261	—	—	—	347	333	2.5	—	—	32.8	31.6	973
292	336	271	279	288	296	349	349	339	2	29.6	28.3	28.3	27.0	850
—	364	276	285	—	—	—	384	367	3	—	—	47.4	45.8	1 370
312	356	291	299	308	316	369	369	359	2	31.6	30.2	30.2	28.8	897
—	384	296	305	—	—	—	404	387	3	—	—	51.1	49.3	1 500
339	391	313	323	335	343	407	407	394	2.5	48.6	46.4	46.4	44.2	1 360
—	418	316	326	—	—	—	444	421	3	—	—	70.8	68.6	2 000
359	411	333	343	355	363	427	427	414	2.5	51.4	49.1	49.0	46.7	1 450
—	438	336	346	—	—	—	464	441	3	—	—	76.2	73.5	2 200
379	—	353	363	375	383	447	—	—	2.5	54.2	51.7	—	—	—
—	473	360	371	—	—	—	500	477	4	—	—	102	98.5	2 950
398	—	373	383	394	402	467	—	—	2.5	57.0	54.4	—	—	—
—	493	380	391	—	—	—	520	497	4	—	—	107	103	3 600
425	—	396	408	420	430	504	—	—	3	84.5	80.6	—	—	—
—	512	400	411	—	—	—	540	516	4	—	—	113	109	3 340
445	—	416	428	440	450	524	—	—	3	88.2	84.1	—	—	—
—	547	420	432	—	—	—	580	551	4	—	—	146	141	4 230
465	—	436	448	460	470	544	—	—	3	92.0	87.7	—	—	—
—	567	440	452	—	—	—	600	571	4	—	—	154	148	4 520
492	—	456	469	487	497	584	—	—	3	127	121	—	—	—
—	596	464	477	—	—	—	626	601	5	—	—	178	172	5 000
512	—	476	489	507	517	604	—	—	3	132	126	—	—	—
—	622	484	498	—	—	—	656	627	5	—	—	202	195	6 030
534	—	500	514	531	541	630	—	—	4	156	149	—	—	—
556	—	520	534	551	561	650	—	—	4	162	155	—	—	—

## High speed single row cylindrical roller bearings

$d$  30~80mm

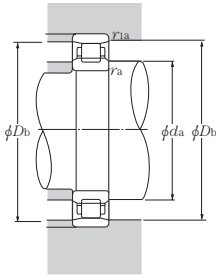


Part number ❶		Boundary dimensions						Basic load ratings				Limiting speeds	
cylindrical bore	tapered bore	$d$	$D$	$B$	$r_{1s} \text{ min}^{\text{❷}}$	$r_{1s} \text{ min}^{\text{❷}}$	$E_w$	dynamic	static	dynamic	static	min <sup>-1</sup>	
								kN		kgf		grease lubrication	oil lubrication
								$C_r$	$C_{or}$	$C_r$	$C_{or}$		
N1006HS	N1006HSK	30	55	13	1	0.6	48.5	17.2	17.6	1 750	1 790	20 500	32 100
N1007HS	N1007HSK	35	62	14	1	0.6	55	21.2	22.5	2 160	2 300	18 000	28 200
N1008HS	N1008HSK	40	68	15	1	0.6	61	24.3	26.3	2 480	2 680	16 100	25 300
N1009HS	N1009HSK	45	75	16	1	0.6	67.5	29.1	32.5	2 970	3 350	14 500	22 800
N1010HS	N1010HSK	50	80	16	1	0.6	72.5	29.9	34.5	3 050	3 550	13 400	21 100
N1011HS	N1011HSK	55	90	18	1.1	1	81	39.0	46.0	4 000	4 700	12 100	18 900
N1012HS	N1012HSK	60	95	18	1.1	1	86.1	40.0	48.5	4 100	4 950	11 300	17 700
N1013HS	N1013HSK	65	100	18	1.1	1	91	42.5	53.5	4 300	5 450	10 600	16 600
N1014HS	N1014HSK	70	110	20	1.1	1	100	52.0	65.5	5 300	6 700	9 700	15 200
N1015HS	N1015HSK	75	115	20	1.1	1	105	53.0	69.0	5 400	7 050	9 200	14 400
N1016HS	N1016HSK	80	125	22	1.1	1	113	63.5	82.0	6 450	8 400	8 500	13 400

❶ A bearing number with suffix K indicates a tapered-bore bearing (taper ratio 1/12).

❷ Minimum allowable value for chamfer dimension  $r$  or  $r_1$ .

❸ N10HS differs from standard N10 in internal construction.



**Dynamic equivalent radial load**

$$P_r = F_r$$

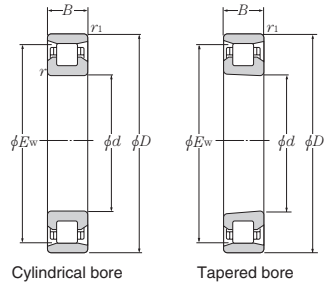
**Static equivalent radial load**

$$P_{0r} = F_r$$

Abutment and fillet dimensions mm					Mass cylindrical bore kg (approx.)	Internal free space cm <sup>3</sup>	Part number	
<i>d</i> <sub>a</sub> min	<i>D</i> <sub>b</sub> max	<i>r</i> <sub>as</sub> min	<i>r</i> <sub>1as</sub> max	cylindrical bore			tapered bore	
35	50	49	1	0.6	0.143	4.33	N1006HS	N1006HSK
40	57	56	1	0.6	0.190	5.06	N1007HS	N1007HSK
45	63	62	1	0.6	0.235	7.10	N1008HS	N1008HSK
50	70	69	1	0.6	0.298	8.85	N1009HS	N1009HSK
55	75	74	1	0.6	0.323	10.8	N1010HS	N1010HSK
61.5	83.5	82	1	1	0.473	15.0	N1011HS	N1011HSK
66.5	88.5	87	1	1	0.505	15.3	N1012HS	N1012HSK
71.5	93.5	92	1	1	0.538	19.0	N1013HS	N1013HSK
76.5	103.5	101	1	1	0.745	22.0	N1014HS	N1014HSK
81.5	108.5	106	1	1	0.787	26.5	N1015HS	N1015HSK
86.5	118.5	114	1	1	1.05	31.1	N1016HS	N1016HSK

## High speed single row cylindrical roller bearings

$d$  85~160mm

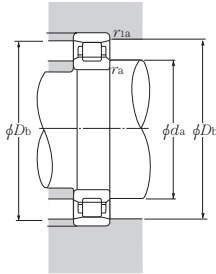


Part number ① ③		Boundary dimensions						Basic load ratings				Limiting speeds	
cylindrical bore	tapered bore	$d$	$D$	$B$	$r_{1s} \text{ min} \text{ ②}$	$r_{1s} \text{ min} \text{ ②}$	$E_w$	dynamic		static		min <sup>-1</sup>	
								$C_r$	$C_{or}$	$C_r$	$C_{or}$	grease lubrication	oil lubrication
N1017HS	N1017HSK	85	130	22	1.1	1	118	65.0	86.0	6 650	8 800	8 100	12 800
N1018HS	N1018HSK	90	140	24	1.5	1.1	127	78.5	105	8 000	10 700	7 600	11 900
N1019HS	N1019HSK	95	145	24	1.5	1.1	132	80.5	110	8 200	11 200	7 300	11 400
N1020HS	N1020HSK	100	150	24	1.5	1.1	137	82.0	115	8 400	11 700	7 000	11 000
N1021HS	N1021HSK	105	160	26	2	1.1	146	109	149	11 100	15 200	6 600	10 400
N1022HS	N1022HSK	110	170	28	2	1.1	155	126	173	12 800	17 700	6 200	9 800
N1024HS	N1024HSK	120	180	28	2	1.1	165	128	182	13 100	18 500	5 800	9 100
N1026HS	N1026HSK	130	200	33	2	1.1	182	156	220	15 900	22 400	5 300	8 300
N1028HS	N1028HSK	140	210	33	2	1.1	192	164	240	16 800	24 400	5 000	7 800
N1030HS	N1030HSK	150	225	35	2.1	1.5	206	185	273	18 800	27 800	4 700	7 300
N1032HS	N1032HSK	160	240	38	2.1	1.5	219	206	305	21 000	31 500	4 400	6 900

① A bearing number with suffix K indicates a tapered-bore bearing (taper ratio 1/12).

② Minimum allowable value for chamfer dimension  $r$  or  $r_1$ .

③ N10HS differs from standard N10 in internal construction.

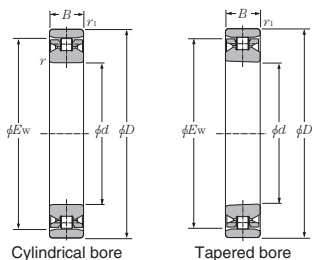


**Dynamic equivalent radial load**  
 $P_r = F_r$   
**Static equivalent radial load**  
 $P_{0r} = F_r$

Abutment and fillet dimensions mm					Mass cylindrical bore kg (approx.)	Internal free space cm <sup>3</sup>	Part number	
$d_a$ min	$D_b$ max	$d_a$ min	$r_{1as}$ max	$r_{1as}$ max			cylindrical bore	tapered bore
91.5	123.5	119	1	1	1.10	33.4	N1017HS	N1017HSK
98	132	129	1.5	1	1.43	40.0	N1018HS	N1018HSK
103	137	134	1.5	1	1.50	46.5	N1019HS	N1019HSK
108	142	139	1.5	1	1.55	53.5	N1020HS	N1020HSK
114	151	148	2	1	1.96	56.2	N1021HS	N1021HSK
119	161	157	2	1	2.44	68.8	N1022HS	N1022HSK
129	171	167	2	1	2.61	87.5	N1024HS	N1024HSK
139	191	183	2	1	3.95	118	N1026HS	N1026HSK
149	201	194	2	1	4.19	130	N1028HS	N1028HSK
161	214	208	2	1.5	5.10	151	N1030HS	N1030HSK
171	229	221	2	1.5	6.30	172	N1032HS	N1032HSK

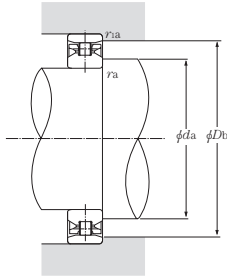
## ULTAGE Ultra high-speed single row cylindrical roller bearings

$d$  45~100mm



Part number ① ②		Boundary dimensions						Basic load ratings				Limiting speeds	
cylindrical bore	tapered bore	$d$	$D$	$B$	$r_1$ min ③	$r_{1s}$ min ③	$E_w$	dynamic kN		dynamic kgf		min <sup>-1</sup>	
								$C_r$	$C_{or}$	$C_r$	$C_{or}$	grease lubrication	oil lubrication
N1009HSRT6	N1009HSRT6K	45	75	16	1	0.6	67.5	21	22.5	2 150	2 290	18 900	37 500
N1011HSRT6	N1011HSRT6K	55	90	18	1.1	1	81	24.1	28.7	2 460	2 930	15 400	30 900
N1012HSRT6	N1012HSRT6K	60	95	18	1.1	1	86.1	23.8	28.9	2 430	2 950	14 400	28 900
N1013HSRT6	N1013HSRT6K	65	100	18	1.1	1	91	25.3	32	2 580	3 250	13 600	27 200
N1014HSRT6	N1014HSRT6K	70	110	20	1.1	1	100	29.2	37.5	2 980	3 850	12 400	24 700
N1016HSRT6	N1016HSRT6K	80	125	22	1.1	1	113	38	50	3 900	5 100	11 000	21 900
N1018HSRT6	N1018HSRT6K	90	140	24	1.5	1.1	127	48	64.5	4 900	6 550	9 700	19 500
N1020HSRT6	N1020HSRT6K	100	150	24	1.5	1.1	137	50.5	70.5	5 150	7 200	9 000	18 000

① Minimum allowable value for chamfer dimension  $r$  or  $r_1$ .

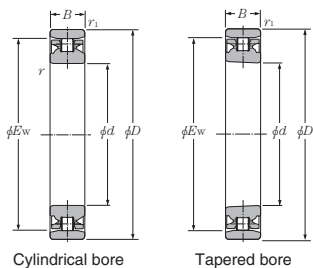


**Dynamic equivalent radial load**  
 $P_r = F_r$   
**Static equivalent radial load**  
 $P_{0r} = F_r$

Abutment and fillet dimensions mm					Internal free space cm <sup>3</sup>	Part number	
$d_a$ min	$D_b$ max	$r_{1as}$ min	$r_{2as}$ max	$r_{1as}$ max		cylindrical bore	tapered bore
50	70	69	1	0.6	9.2	N1009HSRT6	N1009HSRT6K
61.5	83.5	82	1	1	15.7	N1011HSRT6	N1011HSRT6K
66.5	88.5	87	1	1	17.0	N1012HSRT6	N1012HSRT6K
71.5	93.5	92	1	1	17.9	N1013HSRT6	N1013HSRT6K
76.5	103.5	101	1	1	23.3	N1014HSRT6	N1014HSRT6K
86.5	118.5	114	1	1	31.6	N1016HSRT6	N1016HSRT6K
98	132	129	1.5	1	41.1	N1018HSRT6	N1018HSRT6K
108	142	139	1.5	1	45.1	N1020HSRT6	N1020HSRT6K

## ULTAGE Eco-friendly ultra high-speed single row cylindrical roller bearings Air-oil lubrication only

d 55~100mm

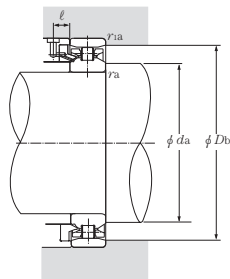


Part number		Boundary dimensions						Basic load ratings				Limiting speeds min <sup>-1</sup> grease lubrication
cylindrical bore	tapered bore	d	D	B	r <sub>s</sub> min <sup>①</sup>	r <sub>is</sub> min <sup>①</sup>	Ew	dynamic kN	static kN	dynamic kgf	static kgf	
								C <sub>r</sub>	C <sub>or</sub>	C <sub>r</sub>	C <sub>or</sub>	
N1011HSLT6	N1011HSLT6K	55	90	18	1.1	1	81	24.1	28.7	2 460	2 930	30 900
N1012HSLT6	N1012HSLT6K	60	95	18	1.1	1	86.1	23.8	28.9	2 430	2 950	28 900
N1013HSLT6	N1013HSLT6K	65	100	18	1.1	1	91	25.3	32	2 580	3 250	27 200
N1014HSLT6	N1014HSLT6K	70	110	20	1.1	1	100	29.2	37.5	2 980	3 850	24 700
N1016HSLT6	N1016HSLT6K	80	125	22	1.1	1	113	38	50	3 900	5 100	21 900
N1018HSLT6	N1018HSLT6K	90	140	24	1.5	1.1	127	48	64.5	4 900	6 550	19 500
N1020HSLT6	N1020HSLT6K	100	150	24	1.5	1.1	137	50.5	70.5	5 150	7 200	18 000

① Minimum allowable value for chamfer dimension  $r$  or  $r_1$ .

② For the details of spacer dimensions, please contact NTN Engineering.





Dynamic equivalent  
radial load  
 $P_r = F_r$   
Static equivalent  
radial load  
 $P_{0r} = F_r$

Abutment and fillet dimensions mm						Part number	
$d_a$ min	$D_b$ max	min	$r_{as}$ max	$r_{as}$ max	$l$ <sup>②</sup> min	cylindrical bore	tapered bore
61.5	83.5	82	1	1	8.5	N1011HSLT6	N1011HSLT6K
66.5	88.5	87	1	1	8.5	N1012HSLT6	N1012HSLT6K
71.5	93.5	92	1	1	8.5	N1013HSLT6	N1013HSLT6K
76.5	103.5	101	1	1	10	N1014HSLT6	N1014HSLT6K
86.5	118.5	114	1	1	10	N1016HSLT6	N1016HSLT6K
98	132	129	1.5	1	10	N1018HSLT6	N1018HSLT6K
108	142	139	1.5	1	10	N1020HSLT6	N1020HSLT6K

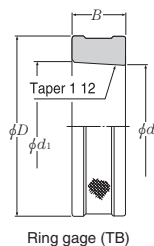
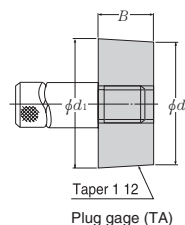
## 13 Taper gage and internal clearance adjustment gage for NTN precision cylindrical roller bearings

As the need increases for machine tools of higher speed and precision, a higher degree of precision is required of machine tool bearings. For a precision bearing to exhibit its full performance, it must be installed correctly. In particular, when a tapered bore bearing is used, the corresponding taper on the shaft must be finished to a high degree of precision. NTN recommends the ring gage for the tapered shaft be finished to the same precision as for bearings. Note that the contact area between tapered faces should be 80% or greater.

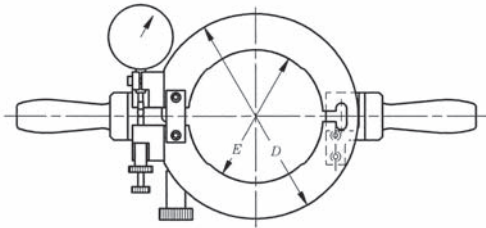
NTN also offers a plug gage that permits verification of the precision of the ring gage. Remember that the radial internal clearance of a cylindrical roller bearing needs to be correctly adjusted. Too large a radial clearance can diminish the precision of the main spindle, while too small a radial clearance can lead to abnormal heat generation and premature flaking of the bearing. To ensure adequate internal clearance, use a mounted internal clearance adjustment gage.

## 14 Dimension table for taper gage

Part number		Applicable bearing	Boundary dimensions				Mass	
Plug gage	Ring gage		mm				kg	type
			$d$	$d_1$	$D$	$B$	type	TA
TANN3006K	TBNN3006K	N1006HS NN3006K	30	31.583	70	19	0.5	0.2
TANN3007K	TBNN3007K	N1007HS NN3007K	35	36.667	75	20	0.6	0.3
TANN3008K	TBNN3008K	N1008HS NN3008K	40	41.750	80	21	0.7	0.3
TANN3009K	TBNN3009K	N1009HS NN3009K	45	46.917	85	23	0.7	0.4
TANN3010K	TBNN3010K	N1010HS NN3010K	50	51.917	90	23	0.8	0.5
TANN3011K	TBNN3011K	N1011HS NN3011K	55	57.167	95	26	0.9	0.7
TANN3012K	TBNN3012K	N1012HS NN3012K	60	62.167	100	26	1.0	0.8
TANN3013K	TBNN3013K	N1013HS NN3013K	65	67.167	105	26	1.1	0.9
TANN3014K	TBNN3014K	N1014HS NN3014K	70	72.500	110	30	1.3	1.3
TANN3015K	TBNN3015K	N1015HS NN3015K	75	77.500	115	30	1.4	1.4
TANN3016K	TBNN3016K	N1016HS NN3016K	80	82.833	125	34	1.9	1.7
TANN3017K	TBNN3017K	N1017HS NN3017K	85	87.833	130	34	2.0	1.9
TANN3018K	TBNN3018K	N1018HS NN3018K	90	93.083	140	37	2.6	2.4
TANN3019K	TBNN3019K	N1019HS NN3019K	95	98.083	145	37	2.7	2.6
TANN3020K	TBNN3020K	N1020HS NN3020K	100	103.083	150	37	2.8	2.8
TANN3021K	TBNN3021K	N1021HS NN3021K	105	108.417	160	41	3.6	3.5
TANN3022K	TBNN3022K	N1022HS NN3022K	110	113.750	165	45	4.1	4.0
TANN3024K	TBNN3024K	N1024HS NN3024K	120	123.833	170	46	4.1	4.7
TANN3026K	TBNN3026K	N1026HS NN3026K	130	134.333	180	52	4.8	6.4
TANN3028K	TBNN3028K	N1028HS NN3028K	140	144.417	190	53	5.2	7.4
TANN3030K	TBNN3030K	N1030HS NN3030K	150	154.667	210	56	7.2	8.4
TANN3032K	TBNN3032K	N1032HS NN3032K	160	165.000	220	60	8.1	10



15 Dimension table for mounted internal clearance adjustment gage



Part number	Applicable bearing	Boundary dimensions mm		
		<i>E</i>	<i>D</i>	width <i>B</i>
SBNN3007-2	N1007HSK NN3007K	55	101	23
SBNN3008-2	N1008HSK NN3008K	61	107	23
SBNN3009-2	N1009HSK NN3009K	67.5	114	23
SBNN3010-2	N1010HSK NN3010K	72.5	120	23
SBNN3011-2	N1011HSK NN3011K	81	131	25
SBNN3012-2	N1012HSK NN3012K	86.1	138	25
SBNN3013-2	N1013HSK NN3013K	91	145	25
SBNN3014-2	N1014HSK NN3014K	100	156	28
SBNN3015-2	N1015HSK NN3015K	105	161	28
SBNN3016-2	N1016HSK NN3016K	113	175	30
SBNN3017-2	N1017HSK NN3017K	118	185	30
SBNN3018-2	N1018HSK NN3018K	127	195	33
SBNN3019-2	N1019HSK NN3019K	132	204	33
SBNN3020-2	N1020HSK NN3020K	137	210	33
SBNN3021-2	N1021HSK NN3021K	146	220	36
SBNN3022-2	N1022HSK NN3022K	155	235	40
SBNN3024-2	N1024HSK NN3024K	165	250	40
SBNN3026-2	N1026HSK NN3026K	182	275	45
SBNN3028-2	N1028HSK NN3028K	192	285	45
SBNN3030-2	N1030HSK NN3030K	206	305	50
SBNN3032-2	N1032HSK NN3032K	219	320	50





## Main Spindle Bearings

### 11. Angular Contact Ball Bearings for Axial Loads CONTENTS

<b>11. Angular Contact Ball Bearings for Axial Loads</b> .....	242~265
① <b>Features and types</b> .....	242
② <b>Standard cage types</b> .....	243
③ <b>Bearing designations</b> .....	243
④ <b>Accuracy of double-direction angular contact thrust ball bearings</b> .....	244
⑤ <b>Accuracy of high-speed duplex angular contact ball bearings for axial loads</b> .....	245
⑥ <b>Basic preload</b> .....	246
⑦ <b>Shaft and housing fits</b> .....	247
⑧ <b>Recommended lubrication specifications</b> .....	247
⑨ <b>Angular contact ball bearings for axial loads HTA U type</b> .....	248
⑩ <b>Dimension tables</b>	
<b>Double-direction angular contact thrust ball bearings</b> .....	250
<b>Angular contact ball bearings for axial loads</b> .....	254

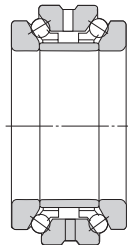
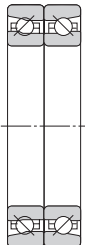
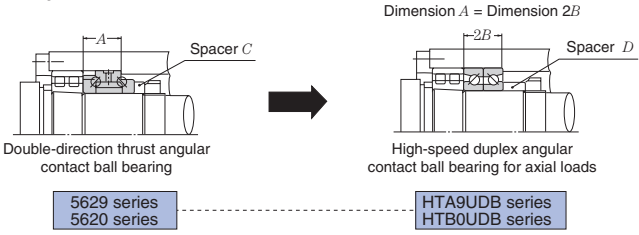
# 11. Angular Contact Ball Bearings for Axial Loads

## ① Features and types

NTN provides a range of thrust bearings for the main spindles. This includes 5629 and 5620 series for high axial rigidity (contact angle 60°) and HTA U(A) series high-speed duplex angular contact ball bearings for axial loads with optimized internal design (contact angle

40°, 30°). These bearings are used in conjunction with NN30, NN49, or NNU49 series double-row cylindrical roller bearings (matched bearings must have the same bore and outside diameter).

**Table 11.1 Types of angular contact ball bearings for axial loads**

	5629 and 5620 series	HTA0U (A)..DB, HTA9U (A)..DB series
Bearing type		
Initial contact angle	60°	40°, 30°
Cage material	High-strength machined brass cage	Molded resin, machined phenolic, high-strength machined copper alloy cage
Features	These series can withstand axial loads in both directions. Due to a larger contact angle, rigidity in axial directions is enhanced. The structure of these bearings limits them to grease-lubricated vertical shaft applications.	These duplex angular contact ball bearing series have similar design to the double-row thrust angular contact ball bearing series, but are different in terms of their widths (see the diagrams below). Since their contact angles are lower at 40° and 30°, the series boast high-speed capability. However, their axial rigidity is less than double-row thrust angular contact ball bearings with 60° contact angle.
Interchangeability	<p>A double-direction thrust angular contact ball bearing can be readily interchanged with a duplex angular contact ball bearing simply by replacing spacer C with spacer D; the dimensions of the shaft and housing remain unchanged.</p>  <p style="text-align: center;">Dimension A = Dimension 2B</p> <div style="display: flex; justify-content: space-around;"> <div style="border: 1px solid black; padding: 2px;">5629 series 5620 series</div> <div style="border: 1px solid black; padding: 2px;">HTA9UDB series HTB0UDB series</div> </div>	

## ② Standard cage types

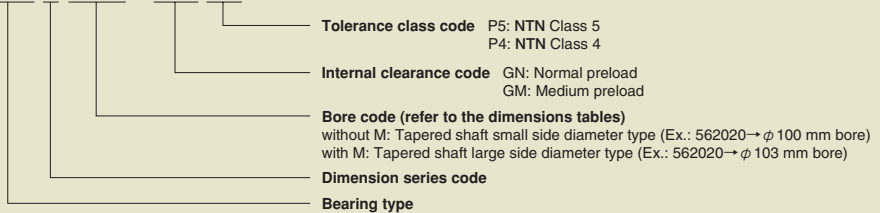
Table 11.2 Standard cage of angular contact ball bearing for axial loads

Bearing series	Machined phenol cage	Machined brass cage
5629	—	562920~562964
5620	—	562005~562064
HTA9U (A)	HTA920U~HTA938U	HTA940U~HTA964U
HTA0U (A)	HTA010U~HTA038U	HTA040U~HTA064U

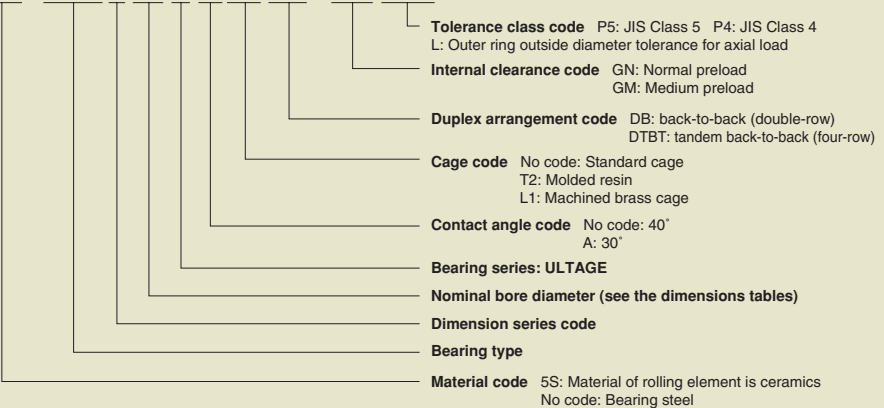
Notes: Cage types may be subjected to change without notice. For details, contact NTN Engineering.

## ③ Bearing designations

### 562 0 20M / GN P4



### 5S - HTA 0 20 U A T2 DB / GN P4L



④ Accuracy of double-direction angular contact thrust ball bearings

Table 11.3 Inner rings

Unit:  $\mu\text{m}$

Nominal bore diameter $d$		Single plane mean bore diameter deviation or bore diameter deviation $d_s$				Perpendicularity of inner ring face with respect to the bore $S_d$		Axial runout $S_{la}$		Width variation $VB_s$		Bearing height deviation $T_s$	
mm		Class 5		Class 4		Class 5	Class 4	Class 5	Class 4	Class 5	Class 4	Class 5	Class 4
over	incl.	high	low	high	low	max		max		max		high	low
18	30	0	-6	0	-5	8	4	5	3	5	2.5	0	-300
30	50	0	-8	0	-6	8	4	5	3	5	3	0	-400
50	80	0	-9	0	-7	8	5	6	5	6	4	0	-500
80	120	0	-10	0	-8	9	5	6	5	7	4	0	-600
120	180	0	-13	0	-10	10	6	8	6	8	5	0	-700
180	250	0	-15	0	-12	11	7	8	6	10	6	0	-800
250	315	0	-18	0	-15	13	8	10	8	13	7	0	-900
315	400	0	-23	0	-18	15	9	13	10	15	9	0	-1000

Table 11.4 Outer rings

Unit:  $\mu\text{m}$

Nominal bore diameter $D$		Single plane mean outside diameter deviation or outside diameter deviation $D_s$		Perpendicularity of outer ring outside surface with respect to the face $S_D$		Axial runout $S_{ea}$		Width variation $VC_s$		
mm		Class 5	Class 4	Class 5	Class 4	Class 5	Class 4	Class 5	Class 4	
over	incl.	high	low	max		max		max		
30	50	-30	-40	8	4	Identical to $\Delta S_{la}$ relative to $d$ of the same bearing.		5	2.5	
50	80	-40	-50	8	4				6	3
80	120	-50	-60	9	5				8	4
120	150	-60	-75	10	5				8	5
150	180	-60	-75	10	5				8	5
180	250	-75	-90	11	7				10	7
250	315	-90	-105	13	8			11	7	
315	400	-110	-125	13	10			13	8	
400	500	-120	-140	15	13			15	10	



⑤ Accuracy of high-speed duplex angular contact ball bearings for axial loads

Table 11.5 Inner rings

Unit:  $\mu\text{m}$

Nominal bore diameter $d$ mm over incl.		Single plane mean bore diameter deviation $d_{mp}$ Class 5 high Class 4 <sup>①</sup> high low high low				Single radial plane bore diameter variation $V_{dsp}$				Mean bore diameter deviation $V_{dmp}$		Perpendicularity of inner ring face with respect to the bore $S_d$		Axial runout $S_{la}$					
						Diameter series 9		Diameter series 0		Class 5 max	Class 4 max	Class 5 max	Class 4 max	Class 5 max	Class 4 max	Class 5 max	Class 4 max	Class 5 max	Class 4 max
						Class 5	Class 4	Class 5	Class 4										
18	30	0	-6	0	-5	6	5	5	4	3	2.5	8	4	5	3				
30	50	0	-8	0	-6	8	6	6	5	4	3	8	4	5	3				
50	80	0	-9	0	-7	9	7	7	5	5	3.5	8	5	6	5				
80	120	0	-10	0	-8	10	8	8	6	5	4	9	5	6	5				
120	150	0	-13	0	-10	13	10	10	8	7	5	10	6	8	6				
150	180	0	-13	0	-10	13	10	10	8	7	5	10	6	8	6				
180	250	0	-15	0	-12	15	12	12	9	8	6	11	7	8	6				
250	315	0	-18	0	-14	18	14	14	11	9	8	13	8	10	8				
315	400	0	-23	0	-16	23	17	18	12	12	9	15	10	13	10				

Unit:  $\mu\text{m}$

① The tolerance of bore diameter deviation  $d_s$  is the same as the tolerance of single plane mean bore diameter deviation  $d_{mp}$ .

Overall width variation of assembled bearing $B_s$ Class 5 high Class 4 low		Width variation $VB_s$		Nominal bore diameter $d$ mm over incl.	
		Class 5 max	Class 4 max		
0	-240	5	2.5	18	30
0	-240	5	3	30	50
0	-300	6	4	50	80
0	-400	7	4	80	120
0	-500	8	5	120	150
0	-500	8	5	150	180
0	-600	10	6	180	250
0	-700	13	8	250	315
0	-800	15	10	315	400

Table 11.6 Outer rings

Unit:  $\mu\text{m}$

Nominal bore diameter $D$ mm over incl.		Single plane mean outside diameter deviation $D_{mp}$ and outside diameter deviation $D_s$ Class 5L or Class 4L <sup>②</sup> high low Class 5 high low Class 4 <sup>②</sup> high low						Axial runout $S_{ea}$		Overall width variation of assembled bearing $C_s$ Identical to $B_s$ relative to $d$ on the same bearing. All classes	Width variation $VC_s$	
		Class 5 All classes		Class 4 All classes		Class 5 max	Class 4 max	Class 5 max	Class 4 max			
		Class 5	Class 4	Class 5	Class 4							
30	50	-25	-36	0	-7	0	-6	8	5	5	2.5	
50	80	-30	-43	0	-9	0	-7	10	5	6	3	
80	120	-36	-51	0	-10	0	-8	11	6	8	4	
120	150	-43	-61	0	-11	0	-9	13	7	8	5	
150	180	-43	-61	0	-13	0	-10	14	8	8	5	
180	250	-50	-70	0	-15	0	-11	15	10	10	7	
250	315	-56	-79	0	-18	0	-13	18	10	11	7	
315	400	-62	-87	0	-20	0	-15	20	13	13	8	
400	500	-68	-95	0	-23	-	-	23	15	15	10	

② The tolerance of outside diameter deviation  $D_s$  to be applied to the Class 4 and Class 2 is same as the tolerance of the mean outside diameter deviation  $d_{mp}$ . Note that the Class 4 is applicable to diameter series 0 and 2, and the Class 2 is applicable to all the diameter series. Note: This standard is the NTN standard.

⑥ Basic preload

The initial internal clearance or initial preload must be selected with consideration of the lubricating method, maximum speed, and required axial rigidity. Although usage with normal preload (GN) within the allowable speed range is possible for both grease lubrication and

air-oil lubrication, ask NTN Engineering to recommend the appropriate preload if axial rigidity is required and you want to inhibit temperature rise of the main spindle. The standard preloads are summarized in **Table 11.7**.

Table 11.7 Basic preload

Unit : N [kgf]

Bore number	5629		5620		HTA9UDB		HTA9UADB		HTA0UDB		HTA0UADB		Bore number
	Normal GN	Medium GM	Normal GN	Medium GM	Normal GN	Medium GM	Normal GN	Medium GM	Normal GN	Medium GM	Normal GN	Medium GM	
05			294 [30]	685 [70]									05
06													06
07			490 [50]	785 [80]									07
08													08
09													09
10													10
11			980 [100]	1 670 [170]					685 [70]	1 270 [130]	490 [50]	885 [90]	11
12													12
13													13
14									980 [100]	1 570 [160]	590 [60]	1 470 [150]	14
15										1 960 [200]			15
16			1 470 [150]	2 450 [250]									16
17													17
18											885 [90]	1 960 [200]	18
19									1 470 [150]	2 450 [250]			19
20	1 470 [150]	2 450 [250]			980 [100]	1 670 [170]	685 [70]	1 270 [130]					20
21													21
22									1 960 [200]	3 450 [350]	980 [100]	2 450 [250]	22
24								885 [90]	1 770 [180]				24
26			1 960 [200]	3 250 [330]	1 270 [130]	2 450 [250]	980 [100]	1 960 [200]	2 940 [300]	5 400 [550]	1 470 [150]	3 450 [350]	26
28	1 960 [200]	2 940 [300]											28
30					1 960 [200]	3 450 [350]	1 270 [130]	2 450 [250]					30
32									3 900 [400]	7 350 [750]	2 450 [250]	4 900 [500]	32
34													34
36					3 450 [350]	5 900 [600]	1 770 [180]	3 450 [350]	4 900 [500]	9 300 [950]			36
38	2 450 [250]	3 900 [400]	2 450 [250]	3 900 [400]							3 450 [350]	6 850 [700]	38
40							2 450 [250]	4 900 [500]					40
44	2 940 [300]	4 400 [450]			3 900 [400]	6 850 [700]				6 850 [700]	12 700 [1 300]		44
48			2 940 [300]	4 400 [450]							3 900 [400]	7 850 [800]	48
52					4 900 [500]	8 850 [900]				8 850 [900]	15 700 [1 600]		52
56	3 900 [400]	5 900 [600]											56
60			3 900 [400]	5 900 [600]	5 900 [600]	11 800 [1 200]					5 900 [600]	11 800 [1 200]	60
64	4 900 [500]	7 350 [750]											64

## 7 Shaft and housing fits

Fits given in Table 11.8 are recommended for angular contact ball bearings for axial loads. To maintain high accuracy, provision of interference between the shaft and the bore of inner ring is essential. The fit of the housing and bearing should be same as that for cylindrical roller bearings, since an angular contact ball bearing is normally used together with a cylindrical roller bearing.

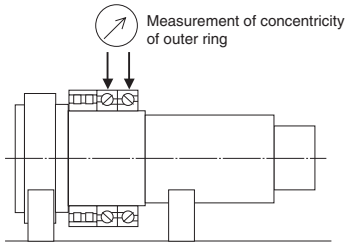


Fig. 11.1 Concentricity

### Checking concentricity of outside diameter of outer ring after bearing

Controlling concentricity of outer ring assembly is necessary for reduction of axial runout of the main spindle. Measure and control the concentricity of outer ring shown in Fig. 11.1 and "6. Handling of Bearings, ② Mounting" in the Technical Data section.

Table 11.8 Fit to shaft Unit:  $\mu\text{m}$

Nominal bore diameter $d$ mm		Fit of inner ring to shaft
over	incl.	
2.5	10	0~2T
10	18	0~2T
18	30	0~2.5T
30	50	0~3T
50	80	0~3.5T
80	120	0~4T
120	180	0~5T
180	250	0~6T

Note 1: Target the median value.

2: For high-speed applications where  $d_{min}$  value exceeds  $0.75 \times 10^6$ , the fit should be increased. For such an arrangement, consult NTN Engineering.

T: Tight (Interference) fit

## 8 Recommended lubrication specifications

Angular contact ball bearings for axial loads are usually used with grease lubrication or air-oil lubrication. Recommended specifications of the lubrication methods are described below.

### Grease lubrication

#### Recommended brand of grease

Refer to "7. Lubrication of Bearings, ① Grease lubrication" in the Technical Data section.

#### Recommended grease filling amount

$d_{min}$  value  $\leq 0.65 \times 10^6$

15% of the capacity shown in the dimensions tables

$d_{min}$  value  $> 0.65 \times 10^6$

12% of the capacity shown in the dimensions tables

#### Recommended grease filling method

Refer to "6. Handling of Bearings, ① Cleaning and filling with grease" in the Technical Data section.

Notes: High-strength machined brass cages are used for 5629/5620 series. Thus, if they are used for grease-lubricated vertical shafts, the cage on one side may hang onto the rolling elements, possibly causing seizure. Use of the HTA series with resin cages or oil lubrication (including feeding of lubricating oil) is recommended.

### Air-oil lubrication

#### Recommended location of nozzle

Refer to "7. Lubrication of Bearings ② Recommended location of nozzle for air-oil lubrication" in the Technical Data section.

#### Recommended specifications of nozzle

Nozzle bore diameter : From 1 to 1.5 mm

Number of nozzles: One nozzle for each bearing, depth of nozzle bore should be four to six times of nozzle bore diameter.

#### Recommended specifications of air-oil

Oil type: Spindle oil

Viscosity grade: ISO VG from 10 to 32 (32 is preferable)

Table 11.9 Air and oil amount

Bearing types	$d_{min}$ value ( $\times 10^6$ )		Oil amount per shot mL	Lubrication intervals min	Oil consumption mL/h	Recommended air consumption * NL/min
	Over	Incl.				
HTA9 (A)	~ 1.0		0.03	8	0.23	20~40
HTA0 (A)	1.0 ~ 1.2			5	0.36	
5S-HTA0 (A)						

\* NL/min (Normal liter/minute) ... NL means the volume of air at 0°C and 1 atmosphere.

9 **ULTAGE** Angular contact ball bearings for axial loads HTA U type

HTA U type angular contact ball bearing has a higher limiting speed with the same rigidity and loading capability as the conventional HTA series.

**Features**

1. Optimized internal design to minimize the temperature rise especially at high speed range.
2. Improved molded nylon cage pocket design where the ball contacts to have improved lubrication performance under grease or air-oil lubrication.

**Bearings design**

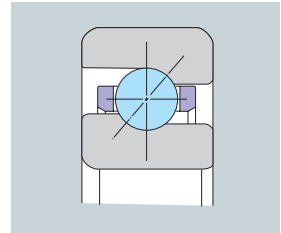
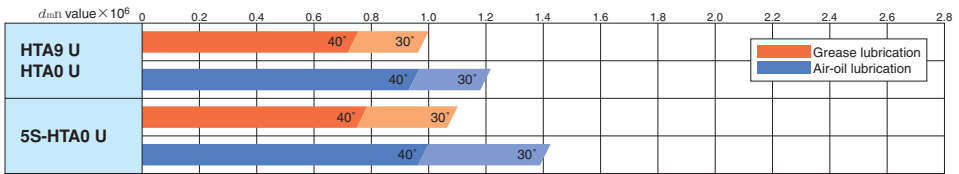


Fig. 11.2 HTA U type

**Permissible speed range**



Notes) Permissible speed of each bearing (d<sub>min</sub> value) varies depending on the specifications of the machine for which the bearing is used (motor drive system, cooling system, and construction around the bearing). Consider the optimal choice referring to the above guideline and contact NTN.

**Axial rigidity**

Axial rigidity is at the same level as the conventional design.

**Data/Allowable axial load**

By reviewing the internal structure, the allowable axial load has improved over HTA types by about 1.3 times with the contact angle of 30° and by about 1.2 times with the contact angle of 40°.

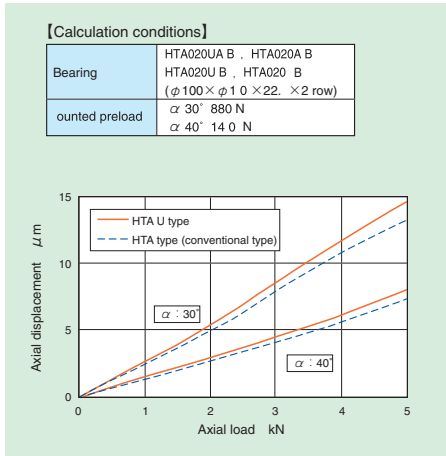


Fig. 11.3 Axial load and rigidity

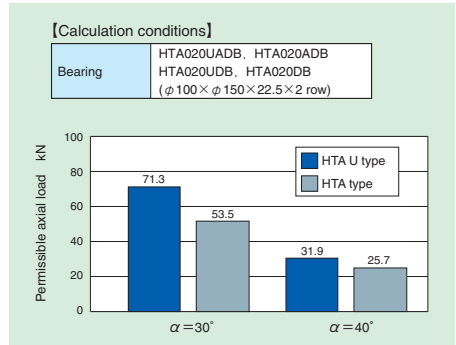


Fig. 11.4 Comparison of permissible axial load

**High speed test**

$d_{min}$  value of  $1.0 \times 10^6$  under grease lubrication and  $1.25 \times 10^6$  under air-oil lubrication are realized by the optimized internal design. (Fig.11.5~11.8)

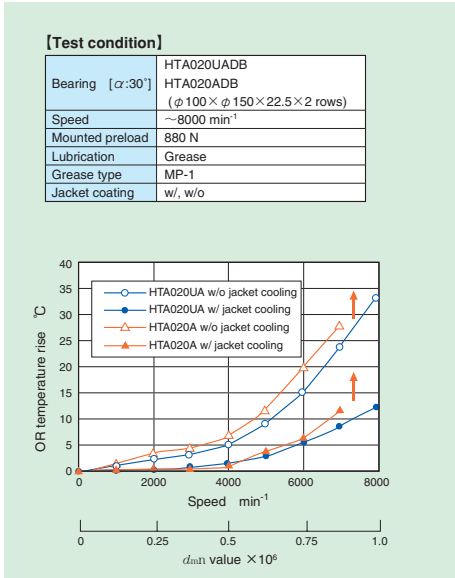


Fig. 11.5 Comparison of temperature rise (Grease,  $\alpha = 30^\circ$ )

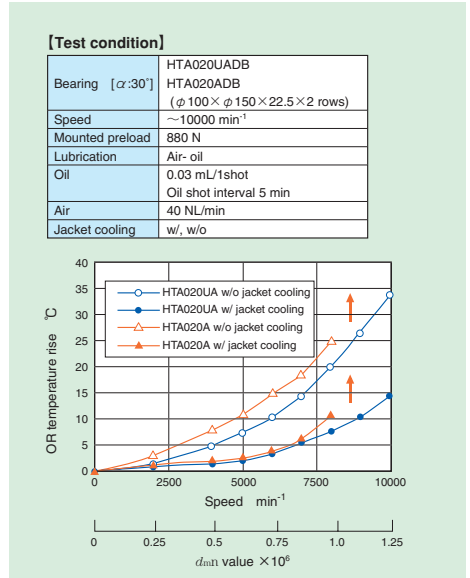


Fig. 11.6 Comparison of temperature rise (Air-oil,  $\alpha = 30^\circ$ )

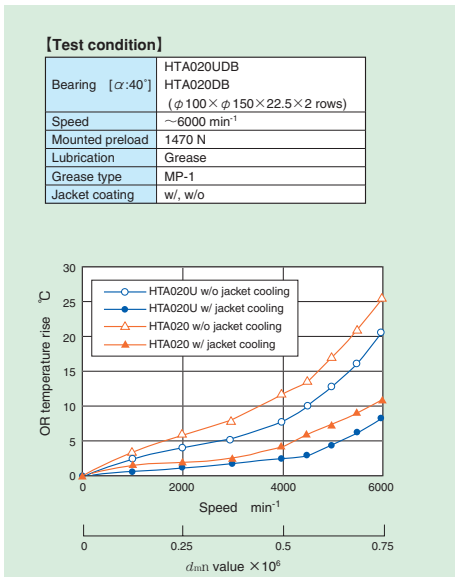


Fig. 11.7 Comparison of temperature rise (Grease,  $\alpha = 40^\circ$ )

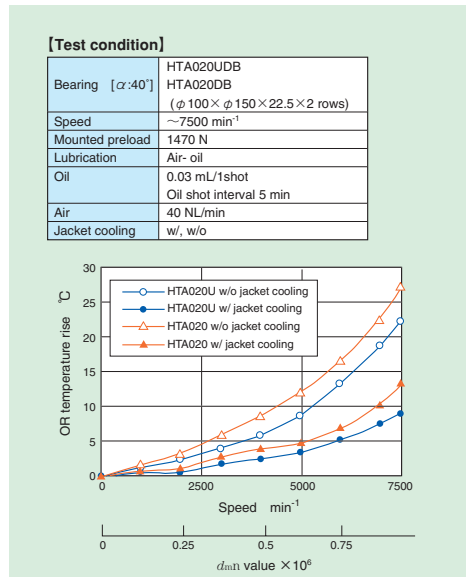
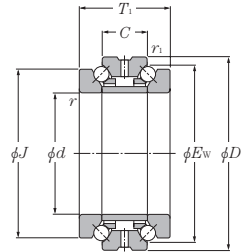


Fig. 11.8 Comparison of temperature rise (Air-oil,  $\alpha = 40^\circ$ )

## ⑩ Dimension tables for angular contact ball bearings

### Double-direction angular contact thrust ball bearings 5629 series

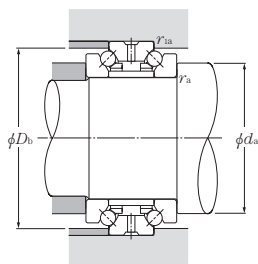
Contact angle 60°  $d$  100~320mm



Part number		Boundary dimensions							Basic load ratings				Limiting speed		Mass	
small size	large size	$d$		mm					dynamic	static	dynamic	static	grease lubrication	oil lubrication	kg	
		small size	large size	$D$	$T_1$	$C$	$r_{1s \text{ min}}^{①}$	$r_{1s \text{ max}}^{②}$	$C_a$	$C_{0a}$	$C_a$	$C_{0a}$			small size	large size
562920	562920M	100	104	140	48	24	1.1	0.6	52.0	179	5 300	18 200	3 200	4 200	2.04	1.8
562921	562921M	105	109	145	48	24	1.1	0.6	53.5	188	5 450	19 200	3 000	4 100	2.12	1.87
562922	562922M	110	114	150	48	24	1.1	0.6	54.0	193	5 500	19 700	2 900	3 900	2.21	1.95
562924	562924M	120	124	165	54	27	1.1	0.6	65.0	242	6 600	24 700	2 600	3 500	3.06	2.75
562926	562926M	130	134	180	60	30	1.5	1	75.0	284	7 650	28 900	2 400	3 200	4.11	3.7
562928	562928M	140	144	190	60	30	1.5	1	76.0	297	7 750	30 500	2 300	3 100	4.38	3.94
562930	562930M	150	155	210	72	36	2	1	107	410	10 900	41 500	2 100	2 800	6.88	6.2
562932	562932M	160	165	220	72	36	2	1	109	430	11 100	44 000	2 000	2 600	7.26	6.53
562934	562934M	170	175	230	72	36	2	1	111	450	11 300	46 000	1 900	2 500	7.64	6.88
562936	562936M	180	186	250	84	42	2	1	156	605	15 900	62 000	1 700	2 300	11.2	10
562938	562938M	190	196	260	84	42	2	1	157	625	16 000	63 500	1 700	2 200	11.7	10.5
562940	562940M	200	207	280	96	48	2.1	1.1	185	735	18 800	75 000	1 600	2 100	16.3	14.7
562944	562944M	220	227	300	96	48	2.1	1.1	190	795	19 400	81 000	1 400	1 900	17.7	16
562948	562948M	240	247	320	96	48	2.1	1.1	196	850	20 000	87 000	1 300	1 800	19	17
562952	562952M	260	269	360	120	60	2.1	1.1	261	1 130	26 600	116 000	1 200	1 600	32.9	29.6
562956	562956M	280	289	380	120	60	2.1	1.1	265	1 190	27 000	121 000	1 100	1 500	35	31.5
562960	562960M	300	310	420	144	72	3	1.1	335	1 510	34 500	154 000	1 000	1 400	55	49.5
562964	562964M	320	330	440	144	72	3	1.1	340	1 580	3 500	161 000	1 000	1 300	58.1	52.3

① Minimum allowable value for corner radius dimension  $r$  or  $r_1$ .

② Maximum circumscribed circle diameter of balls.

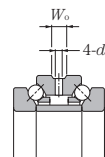


**Dynamic equivalent axial load**

$$P_a = F_a$$

**Static equivalent axial load**

$$P_{0a} = F_a$$



Dimensions of oil hole and oil groove

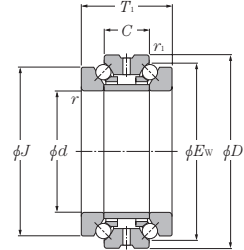
unit: mm

Reference dimensions mm		Abutment and fillet dimensions mm				Part number	
<i>J</i>	<i>E<sub>W</sub></i> <sup>●</sup>	<i>d<sub>a</sub></i> min	<i>D<sub>b</sub></i> max	<i>r<sub>as</sub></i> max	<i>r<sub>1as</sub></i> max	small size	large size
126	129	114	134.5	1	0.6	562920	562920M
131	134	119	139.5	1	0.6	562921	562921M
136	139	124	144.5	1	0.6	562922	562922M
150	154.5	138	159.5	1	0.6	562924	562924M
163	168	150	173.5	1.5	1	562926	562926M
173	178	160	183.5	1.5	1	562928	562928M
190	196.5	174	202	2	1	562930	562930M
200	206.5	184	212	2	1	562932	562932M
210	216.5	194	222	2	1	562934	562934M
227	234	207	242	2	1	562936	562936M
237	344	217	252	2	1	562938	562938M
252	261	231	270	2	1	562940	562940M
272	281	251	290	2	1	562944	562944M
292	301	271	310	2	1	562948	562948M
328	336	299	350	2	1	562952	562952M
348	356	319	370	2	1	562956	562956M
384	391	349	410	2.5	1	562960	562960M
404	411	369	430	2.5	1	562964	562964M

Nominal outer diameter <i>D</i>		Oil groove width	Oil hole diameter
over	incl.	<i>W<sub>o</sub></i>	<i>d<sub>o</sub></i>
150	200	8	4
200	210	12	6
210	260	12	6
260	320	14	6

## Double-direction angular contact thrust ball bearings 5620 series

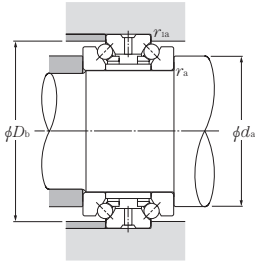
Contact angle 60°  $d$  25~320mm



Part number		Boundary dimensions							Basic load ratings				Limiting speed		Mass	
small size	large size	$d$		mm					dynamic	static	dynamic	static	min <sup>-1</sup>		(approx.)	
		small size	large size	$D$	$T_1$	$C$	$r_1$ min <sup>①</sup>	$r_1$ s min <sup>②</sup>	$C_a$	$C_{oa}$	$C_a$	$C_{oa}$	grease lubrication	oil lubrication	small size	large size
562005	562005M	25	27	47	28	14	0.6	0.3	13.2	28.3	1 350	2 890	10 400	14 000	0.197	0.177
562006	562006M	30	32	55	32	16	1	0.6	14.0	32.5	1 420	3 350	8 700	11 700	0.301	0.28
562007	562007M	35	37	62	34	17	1	0.6	19.7	48.5	2 010	4 950	7 700	10 300	0.394	0.35
562008	562008M	40	42	68	36	18	1	0.6	23.8	58.5	2 430	5 950	7 000	9 400	0.482	0.44
562009	562009M	45	47	75	38	19	1	0.6	26.0	69.0	2 650	7 000	6 200	8 300	0.605	0.54
562010	562010M	50	52	80	38	19	1	0.6	26.8	74.0	2 730	7 550	5 700	7 700	0.638	0.59
562011	562011M	55	57	90	44	22	1.1	0.6	37.0	99.0	3 800	10 100	5 200	7 000	0.988	0.9
562012	562012M	60	62	95	44	22	1.1	0.6	37.5	103	3 850	10 500	4 900	6 500	1.06	0.96
562013	562013M	65	67	100	44	22	1.1	0.6	39.0	111	3 950	11 300	4 600	6 100	1.08	1
562014	562014M	70	73	110	48	24	1.1	0.6	47.5	140	4 850	14 300	4 200	5 600	1.53	1.4
562015	562015M	75	78	115	48	24	1.1	0.6	49.0	150	5 000	15 300	3 900	5 300	1.61	1.5
562016	562016M	80	83	125	54	27	1.1	0.6	57.5	178	5 850	18 200	3 700	4 900	2.2	2
562017	562017M	85	88	130	54	27	1.1	0.6	58.0	184	5 950	18 800	3 500	4 700	2.31	2.1
562018	562018M	90	93	140	60	30	1.5	1	67.5	216	6 850	22 000	3 300	4 400	3.05	2.7
562019	562019M	95	98	145	60	30	1.5	1	68.0	223	6 950	22 700	3 100	4 200	3.18	2.9
562020	562020M	100	103	150	60	30	1.5	1	68.5	229	7 000	23 400	3 000	4 000	3.32	3
562021	562021M	105	109	160	66	33	2	1	78.5	266	8 000	27 100	2 800	3 800	4.19	3.7
562022	562022M	110	114	170	72	36	2	1	96.0	315	9 750	32 500	2 700	3 600	5.35	4.9
562024	562024M	120	124	180	72	36	2	1	98.0	335	10 000	34 500	2 500	3 300	5.73	5.2
562026	562026M	130	135	200	84	42	2	1	139	460	14 200	47 000	2 300	3 100	8.58	7.6
562028	562028M	140	144	210	84	42	2	1	144	495	14 600	50 500	2 200	2 900	9.1	8.1
562030	562030M	150	155	225	90	45	2.1	1.1	147	525	15 000	53 500	2 000	2 700	11.2	10
562032	562032M	160	165	240	96	48	2.1	1.1	172	620	17 600	63 000	1 900	2 500	13.6	11.9
562034	562034M	170	175	260	108	54	2.1	1.1	202	735	20 600	75 000	1 800	2 400	18.5	16.5
562036	562036M	180	186	280	120	60	2.1	1.1	234	865	23 900	88 000	1 600	2 200	24.7	21.8
562038	562038M	190	196	290	120	60	2.1	1.1	236	890	24 100	91 000	1 600	2 100	25.5	23
562040	562040M	200	207	310	132	66	2.1	1.1	271	1 030	27 700	105 000	1 500	2 000	32.7	29.7
562044	562044M	220	227	340	144	72	3	1.1	335	1 270	34 000	129 000	1 300	1 800	42.8	38.5
562048	562048M	240	247	360	144	72	3	1.1	340	1 350	35 000	137 000	1 300	1 700	45.8	41.2
562052	562052M	260	269	400	164	82	4	1.5	405	1 710	41 500	174 000	1 100	1 500	67	60.3
562056	562056M	280	289	420	164	82	4	1.5	415	1 810	42 500	185 000	1 100	1 500	71.1	64
562060	562060M	300	310	460	190	95	4	1.5	475	2 170	48 500	221 000	1 000	1 300	102	91.8
562964	562964M	320	330	480	190	95	4	1.5	480	2 230	4 900	228 000	1 000	1 300	108	97.2

① Minimum allowable value for corner radius dimension  $r$  or  $r_1$ . ② Maximum circumscribed circle diameter of balls.



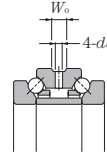


**Dynamic equivalent axial load**

$$P_a \approx F_{ia}$$

**Static equivalent axial load**

$$P_{0a} = F_{ia}$$



Dimensions of oil hole and oil groove

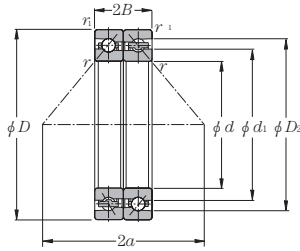
unit: mm

Reference dimensions mm		Abutment and fillet dimensions mm				Part number	
$J$	$E_{w0}$	$d_a$ min	$D_b$ max	$r_{as}$ max	$r_{1as}$ max	small size	large size
40	41.3	33	44	0.6	0.3	562005	562005M
47	48.5	40	50.5	1	0.6	562006	562006M
53	55	45.5	57.5	1	0.6	562007	562007M
58.5	61	50	63.5	1	0.6	562008	562008M
65	67.5	56.5	70.5	1	0.6	562009	562009M
70	72.5	61.5	75.5	1	0.6	562010	562010M
78	81	67.5	84	1	0.6	562011	562011M
83	86.1	72.5	89	1	0.6	562012	562012M
88	91	77.5	94	1	0.6	562013	562013M
97	100	85	104	1	0.6	562014	562014M
102	105	90	109	1	0.6	562015	562015M
110	113	96.5	119	1	0.6	562016	562016M
115	118	102	124	1	0.6	562017	562017M
123	127	109	133.5	1.5	1	562018	562018M
128	132	114	138.5	1.5	1	562019	562019M
133	137	119	143.5	1.5	1	562020	562020M
142	146	127	152	2	1	562021	562021M
150	155	133	162	2	1	562022	562022M
160	165	143	172	2	1	562024	562024M
177	182	155	192	2	1	562026	562026M
187	192	165	202	2	1	562028	562028M
200	206	178	215	2	1	562030	562030M
212	219	189	230	2	1	562032	562032M
230	236	203	250	2	1	562034	562034M
248	255	219	270	2	1	562036	562036M
258	265	229	280	2	1	562038	562038M
274	282	243	300	2	1	562040	562040M
304	310	267	330	2.5	1	562044	562044M
322	330	287	350	2.5	1	562048	562048M
354	364	315	388	3	1.5	562052	562052M
374	384	335	408	3	1.5	562056	562056M
406	418	364	448	3	1.5	562060	562060M
426	438	384	468	3	1.5	562964	562964M

Nominal outer diameter $D$		Oil groove width $W_o$	Oil hole diameter $d_o$
over	incl.		
	50	4.5	2
50	80	6	3
80	150	8	4
150	200	12	6
200	210	12	6
210	260	14	6
260	320	16	8

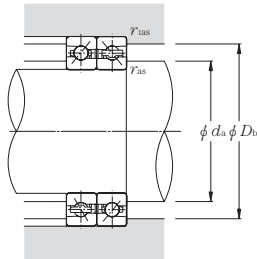
## ULTAGE Angular contact ball bearings for axial loads (steel ball type) HTA9UA series

Contact angle 30°  $d$  100~320mm



Part number	Boundary dimensions					Basic load ratings				Static thrust load capacity		Limiting speed	
	mm					dynamic kN		static kgf		kN	kgf	min <sup>-1</sup>	
	<i>d</i>	<i>D</i>	<i>2B</i>	<i>r</i> <sub>S min</sub> <sup>①</sup>	<i>r</i> <sub>IS min</sub> <sup>①</sup>	<i>C</i> <sub>a</sub>	<i>C</i> <sub>oa</sub>	<i>C</i> <sub>a</sub>	<i>C</i> <sub>oa</sub>			grease lubrication	oil lubrication
HTA920UADB	100	140	36	1.1	0.6	40.0	109	4 050	11 100	66.0	6 750	8 300	10 400
HTA921UADB	105	145	36	1.1	0.6	41.0	115	4 150	11 700	70.0	7 150	8 000	10 000
HTA922UADB	110	150	36	1.1	0.6	41.5	118	4 200	12 000	72.0	7 350	7 700	9 600
HTA924UADB	120	165	40.5	1.1	0.6	48.0	140	4 900	14 300	87.5	8 900	7 000	8 800
HTA926UADB	130	180	45	1.5	1	57.5	173	5 850	17 600	103	10 500	6 500	8 100
HTA928UADB	140	190	45	1.5	1	57.5	177	5 850	18 000	106	10 800	6 100	7 600
HTA930UADB	150	210	54	2	1	80.5	243	8 200	24 800	143	14 600	5 600	6 900
HTA932UADB	160	220	54	2	1	82.0	255	8 350	26 100	151	15 400	5 300	6 600
HTA934UADB	170	230	54	2	1	84.0	268	8 550	27 300	159	16 200	5 000	6 300
HTA936UADB	180	250	63	2	1	127	400	12 900	41 000	239	24 400	4 700	5 800
HTA938UADB	190	260	63	2	1	129	420	13 200	43 000	252	25 700	4 400	5 600
HTA940UADB	200	280	72	2.1	1.1	152	500	15 500	51 000	305	31 000	4 200	5 200
HTA944UADB	220	300	72	2.1	1.1	156	535	15 900	54 500	330	33 500	3 800	4 800
HTA948UADB	240	320	72	2.1	1.1	160	570	16 300	58 000	350	35 500	3 600	4 500
HTA952UADB	260	360	90	2.1	1.1	210	745	21 400	76 000	460	47 000	3 200	4 000
HTA956UADB	280	380	90	2.1	1.1	216	795	22 000	81 000	490	50 000	3 000	3 800
HTA960UADB	300	420	108	3	1.1	276	1 020	28 100	104 000	610	62 000	2 800	3 500
HTA964UADB	320	440	108	3	1.1	280	1 060	28 500	108 000	635	65 000	2 600	3 300

① Minimum allowable value for corner radius dimension *r* or *r*<sub>1</sub>.

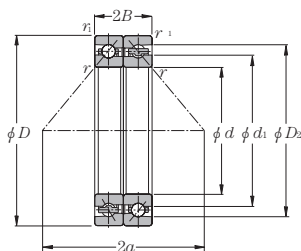


**Dynamic equivalent axial load**  
 $P_{0a}=F_a$   
**Static equivalent axial load**  
 $P_{00}=F_a$

Load center mm	Internal free space cm <sup>3</sup> Two row (approx.)	Mass kg Two row (approx.)	Reference dimensions mm		Abutment and fillet dimensions mm				Part number
			$d_1$	$D_2$	$d_a$ min	$D_b$ max	$r_{as}$ max	$r_{1as}$ max	
87.6	24	0.81	115.3	129.1	110	134	1	0.6	HTA920UADB
90.5	24	0.85	120.3	134.1	115	139	1	0.6	HTA921UADB
93.4	26	0.88	125.3	139.1	120	144	1	0.6	HTA922UADB
102.9	36	1.23	137.4	152.4	130	159	1	0.6	HTA924UADB
112.4	50	1.65	149.4	165.8	142	172.5	1.5	1	HTA926UADB
118.1	53	1.75	159.4	175.8	152	182.5	1.5	1	HTA928UADB
131.4	85	2.74	173.1	193.3	164	202.5	2	1	HTA930UADB
137.1	90	2.89	183.1	203.3	174	212.5	2	1	HTA932UADB
142.9	94	3.05	193.1	213.2	184	222.5	2	1	HTA934UADB
156.2	138	4.78	206.4	231.5	194	242.5	2	1	HTA936UADB
162.0	144	5.00	216.4	241.5	204	252.5	2	1	HTA938UADB
175.2	197	7.00	230.6	258.2	217	270	2	1	HTA940UADB
186.7	213	7.60	250.6	277.9	237	290	2	1	HTA944UADB
198.3	229	8.15	270.6	297.9	257	310	2	1	HTA948UADB
224.7	378	14.3	298.9	331.6	277	350	2	1	HTA952UADB
236.3	403	15.2	318.9	351.4	297	370	2	1	HTA956UADB
262.7	675	23.5	347.1	385.2	320	410	2.5	1	HTA960UADB
274.2	715	24.8	367.1	405.0	340	430	2.5	1	HTA964UADB

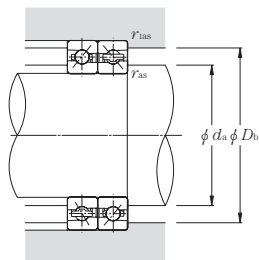
## ULTAGE Angular contact ball bearings for axial loads (steel ball type) HTA9U series

Contact angle 40°  $d$  100~320mm



Part number	Boundary dimensions					Basic load ratings				Static thrust load capacity		Limiting speed	
	mm					dynamic	static	dynamic	static	kN	kgf	min <sup>-1</sup>	
	$d$	$D$	$2B$	$r_3$ min <sup>①</sup>	$r_{1s}$ min <sup>①</sup>	$C_a$	$C_{oa}$	$C_a$	$C_{oa}$			grease lubrication	oil lubrication
HTA920UDB	100	140	36	1.1	0.6	47.0	121	4 800	12 300	29.3	2 990	6 300	7 900
HTA921UDB	105	145	36	1.1	0.6	48.5	128	4 950	13 000	31.0	3 150	6 000	7 600
HTA922UDB	110	150	36	1.1	0.6	49.0	131	5 000	13 400	32.0	3 250	5 800	7 300
HTA924UDB	120	165	40.5	1.1	0.6	57.0	156	5 800	15 900	39.0	4 000	5 300	6 700
HTA926UDB	130	180	45	1.5	1	68.0	193	6 950	19 600	44.5	4 550	4 800	6 100
HTA928UDB	140	190	45	1.5	1	68.0	197	6 950	20 100	46.0	4 700	4 500	5 800
HTA930UDB	150	210	54	2	1	95.5	270	9 750	27 600	62.5	6 350	4 200	5 300
HTA932UDB	160	220	54	2	1	97.5	284	9 950	29 000	65.5	6 700	3 900	5 000
HTA934UDB	170	230	54	2	1	99.5	298	10 100	30 500	69.0	7 050	3 800	4 800
HTA936UDB	180	250	63	2	1	150	445	15 300	45 500	104	10 600	3 500	4 400
HTA938UDB	190	260	63	2	1	153	470	15 600	48 000	110	11 200	3 300	4 200
HTA940UDB	200	280	72	2.1	1.1	180	555	18 400	56 500	134	13 700	3 100	4 000
HTA944UDB	220	300	72	2.1	1.1	185	595	18 900	60 500	145	14 800	2 900	3 700
HTA948UDB	240	320	72	2.1	1.1	190	635	19 400	64 500	155	15 800	2 700	3 400
HTA952UDB	260	360	90	2.1	1.1	250	830	25 400	84 500	203	20 700	2 400	3 100
HTA956UDB	280	380	90	2.1	1.1	257	885	26 200	90 500	218	22 200	2 300	2 900
HTA960UDB	300	420	108	3	1.1	325	1 130	33 500	115 000	266	27 100	2 100	2 600
HTA964UDB	320	440	108	3	1.1	330	1 180	34 000	120 000	279	28 400	2 000	2 500

① Minimum allowable value for corner radius dimension  $r$  or  $r_1$ .



**Dynamic equivalent axial load**

$$P_{0a}=F_a$$

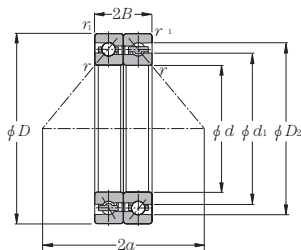
**Static equivalent axial load**

$$P_{00}=F_a$$

Load center mm	Internal free space cm <sup>3</sup> Two row (approx.)	Mass kg Two row (approx.)	Reference dimensions mm		Abutment and fillet dimensions mm				Part number
			$d_1$	$D_2$	$d_a$ min	$D_b$ max	$r_{as}$ max	$r_{1as}$ max	
119.1	24	0.81	115.3	129.0	110	134	1	0.6	HTA920UDB
123.3	24	0.85	120.3	134.0	115	139	1	0.6	HTA921UDB
127.5	26	0.88	125.3	139.0	120	144	1	0.6	HTA922UDB
140.3	36	1.23	137.4	152.3	130	159	1	0.6	HTA924UDB
153.1	50	1.65	149.4	165.7	142	172.5	1.5	1	HTA926UDB
161.5	53	1.75	159.4	175.7	152	182.5	1.5	1	HTA928UDB
178.7	85	2.74	173.1	193.2	164	202.5	2	1	HTA930UDB
187.1	90	2.89	183.1	203.2	174	212.5	2	1	HTA932UDB
195.5	94	3.05	193.1	213.3	184	222.5	2	1	HTA934UDB
212.7	138	4.78	206.4	231.5	194	242.5	2	1	HTA936UDB
221.1	144	5.00	216.4	241.6	204	252.5	2	1	HTA938UDB
238.3	197	7.00	230.6	258.2	217	270	2	1	HTA940UDB
255.1	213	7.60	250.6	278.2	237	290	2	1	HTA944UDB
271.8	229	8.15	270.6	298.0	257	310	2	1	HTA948UDB
306.2	378	14.3	298.9	331.6	277	350	2	1	HTA952UDB
323.0	403	15.2	318.9	351.6	297	370	2	1	HTA956UDB
357.3	675	23.5	347.1	385.0	320	410	2.5	1	HTA960UDB
374.1	715	24.8	367.1	405.2	340	430	2.5	1	HTA964UDB

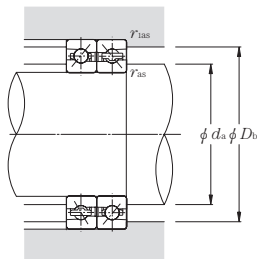
## ULTAGE Angular contact ball bearings for axial loads (steel ball type) HTA0UA series

Contact angle 30°  $d$  50~320mm



Part number	Boundary dimensions						Basic load ratings				Static thrust load capacity		Limiting speed	
	mm						dynamic	static	dynamic	static	kN	kgf	min <sup>-1</sup>	
	$d$	$D$	$2B$	$r_1$ min <sup>①</sup>	$r_1$ min <sup>①</sup>	$C_a$	$C_{oa}$	$C_a$	$C_{oa}$	grease lubrication			oil lubrication	
HTA010UADB	50	80	28.5	1	0.6	24.7	48.5	2 520	4 950	23.2	2 370	15 400	19 200	
HTA011UADB	55	90	33	1.1	0.6	26.8	57.5	2 730	5 850	27.7	2 820	13 800	17 200	
HTA012UADB	60	95	33	1.1	0.6	28.1	63.0	2 860	6 400	30.5	3 100	12 900	16 100	
HTA013UADB	65	100	33	1.1	0.6	28.5	65.0	2 900	6 650	32.0	3 250	12 100	15 200	
HTA014UADB	70	110	36	1.1	0.6	35.0	82.0	3 550	8 350	40.0	4 100	11 100	13 900	
HTA015UADB	75	115	36	1.1	0.6	37.0	91.5	3 800	9 300	45.5	4 650	10 500	13 200	
HTA016UADB	80	125	40.5	1.1	0.6	42.5	105	4 350	10 700	52.0	5 300	9 800	12 200	
HTA017UADB	85	130	40.5	1.1	0.6	43.0	108	4 400	11 100	54.5	5 550	9 300	11 600	
HTA018UADB	90	140	45	1.5	1	50.0	127	5 100	13 000	63.5	6 500	8 700	10 900	
HTA019UADB	95	145	45	1.5	1	50.5	131	5 150	13 400	66.0	6 750	8 300	10 400	
HTA020UADB	100	150	45	1.5	1	52.5	140	5 350	14 300	71.0	7 250	8 000	10 000	
HTA021UADB	105	160	49.5	2	1	60.0	163	6 100	16 600	82.5	8 400	7 500	9 400	
HTA022UADB	110	170	54	2	1	74.5	200	7 600	20 400	100	10 200	7 100	8 900	
HTA024UADB	120	180	54	2	1	75.0	206	7 650	21 000	104	10 600	6 700	8 300	
HTA026UADB	130	200	63	2	1	108	293	11 000	29 900	144	14 700	6 100	7 600	
HTA028UADB	140	210	63	2	1	111	315	11 300	32 000	156	15 900	5 700	7 100	
HTA030UADB	150	225	67.5	2.1	1.1	114	330	11 700	34 000	169	17 200	5 300	6 700	
HTA032UADB	160	240	72	2.1	1.1	134	390	13 700	40 000	196	20 000	5 000	6 300	
HTA034UADB	170	260	81	2.1	1.1	153	450	15 900	46 000	226	23 000	4 700	5 800	
HTA036UADB	180	280	90	2.1	1.1	177	530	18 100	54 000	265	27 000	4 300	5 400	
HTA038UADB	190	290	91	2.1	1.1	179	545	18 300	55 500	275	28 000	4 200	5 200	
HTA040UADB	200	310	99	2.1	1.1	201	610	20 500	62 000	310	31 500	3 900	4 900	
HTA044UADB	220	340	108	3	1.1	253	775	25 800	79 000	385	39 500	3 600	4 500	
HTA048UADB	240	360	108	3	1.1	261	825	26 600	84 000	415	42 500	3 300	4 200	
HTA052UADB	260	400	123	4	1.5	310	1040	31 500	106 000	520	53 500	3 000	3 800	
HTA056UADB	280	420	123	4	1.5	315	1110	32 500	113 000	565	57 500	2 900	3 600	
HTA060UADB	300	460	142.5	4	1.5	360	1330	37 000	135 000	670	68 500	2 600	3 300	
HTA064UADB	320	480	142.5	4	1.5	365	1360	37 000	139 000	700	71 500	2 500	3 100	

① Minimum allowable value for corner radius dimension  $r$  or  $r_1$ .



**Dynamic equivalent axial load**

$$P_a = F_a$$

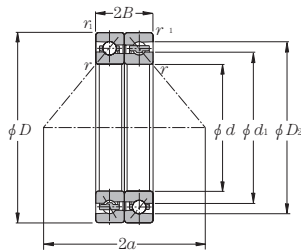
**Static equivalent axial load**

$$P_{0a} = F_a$$

Load center mm	Internal free space cm <sup>3</sup>	Mass kg	Reference dimensions mm		Abutment and fillet dimensions mm				Part number
			Two row (approx.)	Two row (approx.)	$d_1$	$D_2$	$d_a$ min	$D_b$ max	
52.1	9	0.24	60.7	73.2	57.5	74.0	1	0.6	HTA010UADB
58.6	13	0.39	68.2	80.8	65.0	84.0	1	0.6	HTA011UADB
61.5	13	0.41	73.2	85.8	70.0	89.0	1	0.6	HTA012UADB
64.4	14	0.44	78.2	90.8	75.0	94.0	1	0.6	HTA013UADB
70.3	18	0.61	85.3	99.1	80.0	104	1	0.6	HTA014UADB
73.2	19	0.65	90.3	104.1	85.0	109	1	0.6	HTA015UADB
79.8	26	0.88	97.4	112.5	90.0	119	1	0.6	HTA016UADB
82.7	28	0.93	102.4	117.5	95.0	124	1	0.6	HTA017UADB
89.3	38	1.22	109.4	125.9	102	132.5	1.5	1	HTA018UADB
92.1	39	1.27	114.4	130.9	107	137.5	1.5	1	HTA019UADB
95.1	39	1.34	119.5	136.0	112	142.5	1.5	1	HTA020UADB
101.6	49	1.74	126.5	144.3	119	152.5	2	1	HTA021UADB
108.3	66	2.14	133.1	153.4	124	162.5	2	1	HTA022UADB
114.1	67	2.32	143.3	163.5	134	172.5	2	1	HTA024UADB
127.3	108	3.39	156.4	181.7	144	192.5	2	1	HTA026UADB
133.1	114	3.60	166.4	191.7	154	202.5	2	1	HTA028UADB
142.6	141	4.46	178.9	204.3	167	215	2	1	HTA030UADB
152.1	168	5.40	190.6	218.0	177	230	2	1	HTA032UADB
165.3	238	7.20	204.7	235.3	187	250	2	1	HTA034UADB
178.5	285	10.6	218.9	251.8	197	270	2	1	HTA036UADB
184.3	300	11.0	228.9	261.7	207	280	2	1	HTA038UADB
197.5	436	13.8	243.0	278.5	217	300	2	1	HTA040UADB
216.6	550	18.1	266.3	306.9	240	330	2.5	1	HTA044UADB
228.1	650	18.9	286.3	326.8	260	350	2.5	1	HTA048UADB
253.0	850	28.4	314.6	360.3	283	388	3	1.5	HTA052UADB
264.6	900	30.2	334.6	380.3	303	408	3	1.5	HTA056UADB
291.8	1265	43.6	362.9	414.0	323	448	3	1.5	HTA060UADB
303.3	1340	45.8	382.9	433.9	343	468	3	1.5	HTA064UADB

## ULTAGE Angular contact ball bearings for axial loads (steel ball type) HTAOU series

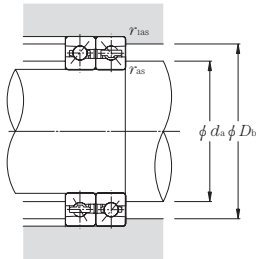
Contact angle 40°  $d$  50~320mm



Part number	Boundary dimensions						Basic load ratings				Static thrust load capacity		Limiting speed	
	mm						dynamic kN		static kgf		kN	kgf	min <sup>-1</sup>	
	$d$	$D$	$2B$	$r_3$ min <sup>①</sup>	$r_{18}$ min <sup>①</sup>	$C_a$	$C_{0a}$	$C_a$	$C_{0a}$	grease lubrication			oil lubrication	
HTA010UB	50	80	28.5	1	0.6	29.6	55.5	3 000	5 650	12.3	1 250	11 500	14 600	
HTA011UB	55	90	33	1.1	0.6	32.0	64.0	3 250	6 500	14.3	1 460	10 300	13 100	
HTA012UB	60	95	33	1.1	0.6	33.5	69.5	3 400	7 100	15.7	1 600	9 700	12 300	
HTA013UB	65	100	33	1.1	0.6	34.0	72.0	3 450	7 350	16.4	1 670	9 100	11 500	
HTA014UB	70	110	36	1.1	0.6	41.5	91.0	4 250	9 300	21.5	2 190	8 300	10 600	
HTA015UB	75	115	36	1.1	0.6	44.0	101.0	4 500	10 300	24.0	2 450	7 900	10 000	
HTA016UB	80	125	40.5	1.1	0.6	50.5	117	5 150	11 900	28.4	2 900	7 300	9 300	
HTA017UB	85	130	40.5	1.1	0.6	51.0	120	5 200	12 300	29.4	3 000	7 000	8 800	
HTA018UB	90	140	45	1.5	1	59.5	141	6 050	14 400	32.0	3 250	6 500	8 300	
HTA019UB	95	145	45	1.5	1	60.0	146	6 100	14 900	33.5	3 400	6 300	7 900	
HTA020UB	100	150	45	1.5	1	62.0	156	6 350	15 900	35.5	3 600	6 000	7 600	
HTA021UB	105	160	49.5	2	1	71.0	181	7 250	18 400	42.5	4 350	5 700	7 200	
HTA022UB	110	170	54	2	1	88.5	222	9 000	22 700	50.0	5 100	5 400	6 800	
HTA024UB	120	180	54	2	1	89.0	228	9 050	23 300	52.0	5 300	5 000	6 300	
HTA026UB	130	200	63	2	1	128	325	13 000	33 000	74.0	7 550	4 500	5 800	
HTA028UB	140	210	63	2	1	132	345	13 500	35 500	79.5	8 100	4 300	5 400	
HTA030UB	150	225	67.5	2.1	1.1	136	370	13 800	37 500	85.0	8 650	4 000	5 200	
HTA032UB	160	240	72	2.1	1.1	159	435	16 200	44 000	103	10 500	3 800	4 800	
HTA034UB	170	260	81	2.1	1.1	182	500	18 600	51 000	116	11 800	3 500	4 400	
HTA036UB	180	280	90	2.1	1.1	211	585	21 500	60 000	140	14 300	3 300	4 100	
HTA038UB	190	290	91	2.1	1.1	214	605	21 800	61 500	145	14 800	3 100	4 000	
HTA040UB	200	310	99	2.1	1.1	240	680	24 400	69 000	159	16 200	2 900	3 700	
HTA044UB	220	340	108	3	1.1	300	860	30 500	87 500	201	20 500	2 700	3 400	
HTA048UB	240	360	108	3	1.1	310	915	31 500	93 000	216	22 000	2 500	3 200	
HTA052UB	260	400	123	4	1.5	365	1160	37 500	118 000	275	28 000	2 300	2 900	
HTA056UB	280	420	123	4	1.5	375	1230	38 500	125 000	293	29 900	2 100	2 700	
HTA060UB	300	460	142.5	4	1.5	430	1470	44 000	150 000	355	36 000	2 000	2 500	
HTA064UB	320	480	142.5	4	1.5	435	1520	44 000	155 000	365	37 000	1 900	2 400	

① Minimum allowable value for corner radius dimension  $r$  or  $r_1$ .





**Dynamic equivalent axial load**

$$P_{0a}=F_a$$

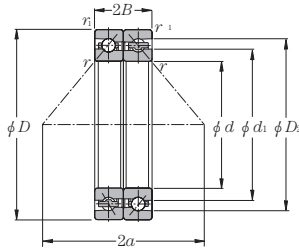
**Static equivalent axial load**

$$P_{00}=F_a$$

Load center mm	Internal free space cm <sup>3</sup>	Mass kg	Reference dimensions mm		Abutment and fillet dimensions mm				Part number
			<i>d</i> <sub>1</sub>	<i>D</i> <sub>2</sub>	<i>d</i> <sub>a</sub> min	<i>D</i> <sub>b</sub> max	<i>r</i> <sub>as</sub> max	<i>r</i> <sub>ias</sub> max	
2 <i>a</i>	Two row (approx.)	Two row (approx.)							
69.2	9	0.24	60.7	73.1	57.5	74.0	1	0.6	HTA010UDB
77.7	13	0.39	68.2	80.7	65.0	84.0	1	0.6	HTA011UDB
81.9	13	0.41	73.2	85.7	70.0	89.0	1	0.6	HTA012UDB
86.1	14	0.44	78.2	90.7	75.0	94.0	1	0.6	HTA013UDB
94.0	18	0.61	85.3	99.0	80.0	104	1	0.6	HTA014UDB
98.2	19	0.65	90.3	104.0	85.0	109	1	0.6	HTA015UDB
106.7	26	0.88	97.4	112.4	90.0	119	1	0.6	HTA016UDB
110.9	28	0.93	102.4	117.4	95.0	124	1	0.6	HTA017UDB
119.5	38	1.22	109.4	125.8	102	132.5	1.5	1	HTA018UDB
123.7	39	1.27	114.4	130.8	107	137.5	1.5	1	HTA019UDB
128.0	39	1.34	119.5	135.9	112	142.5	1.5	1	HTA020UDB
136.5	49	1.74	126.5	144.2	119	152.5	2	1	HTA021UDB
145.1	66	2.14	133.1	153.3	124	162.5	2	1	HTA022UDB
153.6	67	2.32	143.3	163.4	134	172.5	2	1	HTA024UDB
170.8	108	3.39	156.4	181.6	144	192.5	2	1	HTA026UDB
179.2	114	3.60	166.4	191.6	154	202.5	2	1	HTA028UDB
191.9	141	4.46	178.9	204.2	167	215	2	1	HTA030UDB
204.7	168	5.40	190.6	218.4	177	230	2	1	HTA032UDB
221.9	238	7.20	204.7	235.2	187	250	2	1	HTA034UDB
239.1	285	10.6	218.9	251.6	197	270	2	1	HTA036UDB
247.4	300	11.0	228.9	261.6	207	280	2	1	HTA038UDB
264.6	436	13.8	243.0	278.4	217	300	2	1	HTA040UDB
290.3	550	18.1	266.3	306.7	240	330	2.5	1	HTA044UDB
307.0	650	18.9	286.3	326.6	260	350	2.5	1	HTA048UDB
339.9	850	28.4	314.6	360.1	283	388	3	1.5	HTA052UDB
356.7	900	30.2	334.6	380.1	303	408	3	1.5	HTA056UDB
391.7	1265	43.6	362.9	413.7	323	448	3	1.5	HTA060UDB
408.5	1340	45.8	382.9	433.7	343	468	3	1.5	HTA064UDB

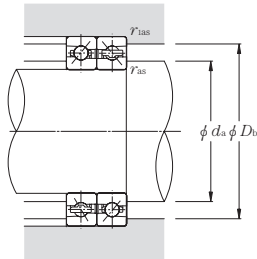
## ULTAGE Angular contact ball bearings for axial loads (ceramic ball type) 5S-HTA0UA series

Contact angle 30°  $d$  50~130mm



Part number	Boundary dimensions						Basic load ratings				Static thrust load capacity		Limiting speed		
	mm						dynamic kN		static kgf		kN		kgf		min <sup>-1</sup>
	$d$	$D$	$2B$	$r_3$ min <sup>①</sup>	$r_{1S}$ min <sup>①</sup>	$C_a$	$C_{0a}$	$C_a$	$C_{0a}$			grease lubrication	oil lubrication		
5S-HTA010UADB	50	80	28.5	1	0.6	24.7	33.5	2 520	3 400	15.7	1 600	17 300	22 200		
5S-HTA011UADB	55	90	33	1.1	0.6	26.8	40.0	2 730	4 050	18.6	1 900	15 500	19 900		
5S-HTA012UADB	60	95	33	1.1	0.6	28.1	43.5	2 860	4 450	20.5	2 090	14 500	18 600		
5S-HTA013UADB	65	100	33	1.1	0.6	28.5	45.0	2 900	4 600	21.6	2 200	13 600	17 500		
5S-HTA014UADB	70	110	36	1.1	0.6	35.0	57.0	3 550	5 800	27.2	2 770	12 500	16 000		
5S-HTA015UADB	75	115	36	1.1	0.6	37.0	63.5	3 800	6 450	30.5	3 150	11 800	15 200		
5S-HTA016UADB	80	125	40.5	1.1	0.6	42.5	73.0	4 350	7 400	35.0	3 600	11 000	14 100		
5S-HTA017UADB	85	130	40.5	1.1	0.6	43.0	75.0	4 400	7 650	36.5	3 750	10 500	13 400		
5S-HTA018UADB	90	140	45	1.5	1	49.5	88.5	5 050	9 000	43.0	4 400	9 800	12 500		
5S-HTA019UADB	95	145	45	1.5	1	50.5	91.0	5 150	9 300	44.5	4 550	9 400	12 000		
5S-HTA020UADB	100	150	45	1.5	1	52.5	97.0	5 350	9 900	48.0	4 900	9 000	11 500		
5S-HTA021UADB	105	160	49.5	2	1	60.0	113	6 100	11 500	55.5	5 650	8 500	10 900		
5S-HTA022UADB	110	170	54	2	1	74.0	139	7 550	14 100	67.0	6 850	8 000	10 300		
5S-HTA024UADB	120	180	54	2	1	75.0	143	7 650	14 500	70.0	7 150	7 500	9 600		
5S-HTA026UADB	130	200	63	2	1	108	203	11 000	20 700	97.0	9 900	6 800	8 700		

① Minimum allowable value for corner radius dimension  $r$  or  $r_1$ .



**Dynamic equivalent axial load**

$$P_{0a}=F_a$$

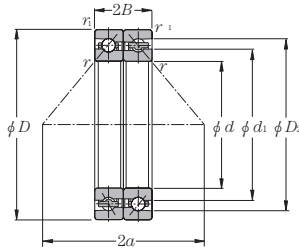
**Static equivalent axial load**

$$P_{00}=F_a$$

Load center mm	Internal free space cm <sup>3</sup>	Mass kg	Reference dimensions mm		Abutment and fillet dimensions mm				Part number
			$d_1$	$D_2$	$d_a$ min	$D_b$ max	$r_{as}$ max	$r_{1as}$ max	
2a	Two row (approx.)	Two row (approx.)							
52.1	9	0.22	60.7	73.2	57.5	74.0	1	0.6	5S-HTA010UADB
58.6	13	0.36	68.2	80.8	65.0	84.0	1	0.6	5S-HTA011UADB
61.5	13	0.39	73.2	85.8	70.0	89.0	1	0.6	5S-HTA012UADB
64.4	14	0.41	78.2	90.8	75.0	94.0	1	0.6	5S-HTA013UADB
70.3	18	0.57	85.3	99.1	80.0	104	1	0.6	5S-HTA014UADB
73.2	19	0.60	90.3	104.1	85.0	109	1	0.6	5S-HTA015UADB
79.8	26	0.83	97.4	112.5	90.0	119	1	0.6	5S-HTA016UADB
82.7	28	0.87	102.4	117.5	95.0	124	1	0.6	5S-HTA017UADB
89.3	38	1.15	109.4	125.9	102	132.5	1.5	1	5S-HTA018UADB
92.1	39	1.20	114.4	130.9	107	137.5	1.5	1	5S-HTA019UADB
95.1	39	1.26	119.5	136.0	112	142.5	1.5	1	5S-HTA020UADB
101.6	49	1.64	126.5	144.3	119	152.5	2	1	5S-HTA021UADB
108.3	66	2.00	133.1	153.4	124	162.5	2	1	5S-HTA022UADB
114.1	67	2.17	143.3	163.5	134	172.5	2	1	5S-HTA024UADB
127.3	108	3.13	156.4	181.7	144	192.5	2	1	5S-HTA026UADB

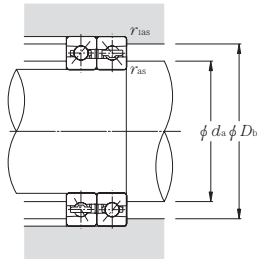
## ULTAGE Angular contact ball bearings for axial loads (ceramic ball type) 5S-HTA0U series

Contact angle 40°  $d$  50~130mm



Part number	Boundary dimensions						Basic load ratings				Static thrust load capacity		Limiting speed	
	mm						dynamic	static	dynamic	static	kN	kgf	min <sup>-1</sup>	
	$d$	$D$	$2B$	$r_{1s \text{ min}}$ ①	$r_{1s \text{ min}}$ ①		$C_a$	$C_{0a}$	$C_a$	$C_{0a}$			grease lubrication	oil lubrication
5S-HTA010UDB	50	80	28.5	1	0.6	29.6	38.5	3 000	3 900	14.6	1 490	12 200	15 400	
5S-HTA011UDB	55	90	33	1.1	0.6	32.0	44.5	3 250	4 500	17.1	1 740	10 900	13 800	
5S-HTA012UDB	60	95	33	1.1	0.6	33.5	48.0	3 400	4 900	18.7	1 910	10 200	12 900	
5S-HTA013UDB	65	100	33	1.1	0.6	34.0	50.0	3 450	5 100	19.6	2 000	9 600	12 100	
5S-HTA014UDB	70	110	36	1.1	0.6	41.5	63.0	4 250	6 450	25.6	2 610	8 800	11 100	
5S-HTA015UDB	75	115	36	1.1	0.6	44.0	70.5	4 500	7 150	28.7	2 930	8 300	10 500	
5S-HTA016UDB	80	125	40.5	1.1	0.6	50.5	81.0	5 150	8 250	34.0	3 450	7 700	9 800	
5S-HTA017UDB	85	130	40.5	1.1	0.6	51.0	83.5	5 200	8 500	35.0	3 600	7 300	9 300	
5S-HTA018UDB	90	140	45	1.5	1	59.5	98.0	6 050	10 000	38.0	3 900	6 900	8 700	
5S-HTA019UDB	95	145	45	1.5	1	60.0	101	6 100	10 300	39.5	4 050	6 600	8 300	
5S-HTA020UDB	100	150	45	1.5	1	62.0	108	6 350	11 000	42.5	4 300	6 300	8 000	
5S-HTA021UDB	105	160	49.5	2	1	71.0	125	7 250	12 800	50.5	5 150	6 000	7 500	
5S-HTA022UDB	110	170	54	2	1	88.5	154	9 000	15 700	59.5	6 100	5 600	7 100	
5S-HTA024UDB	120	180	54	2	1	89.0	158	9 050	16 100	61.5	6 300	5 300	6 700	
5S-HTA026UDB	130	200	63	2	1	128	225	13 000	23 000	88.0	9 000	4 800	6 100	

① Minimum allowable value for corner radius dimension  $r$  or  $r_1$ .



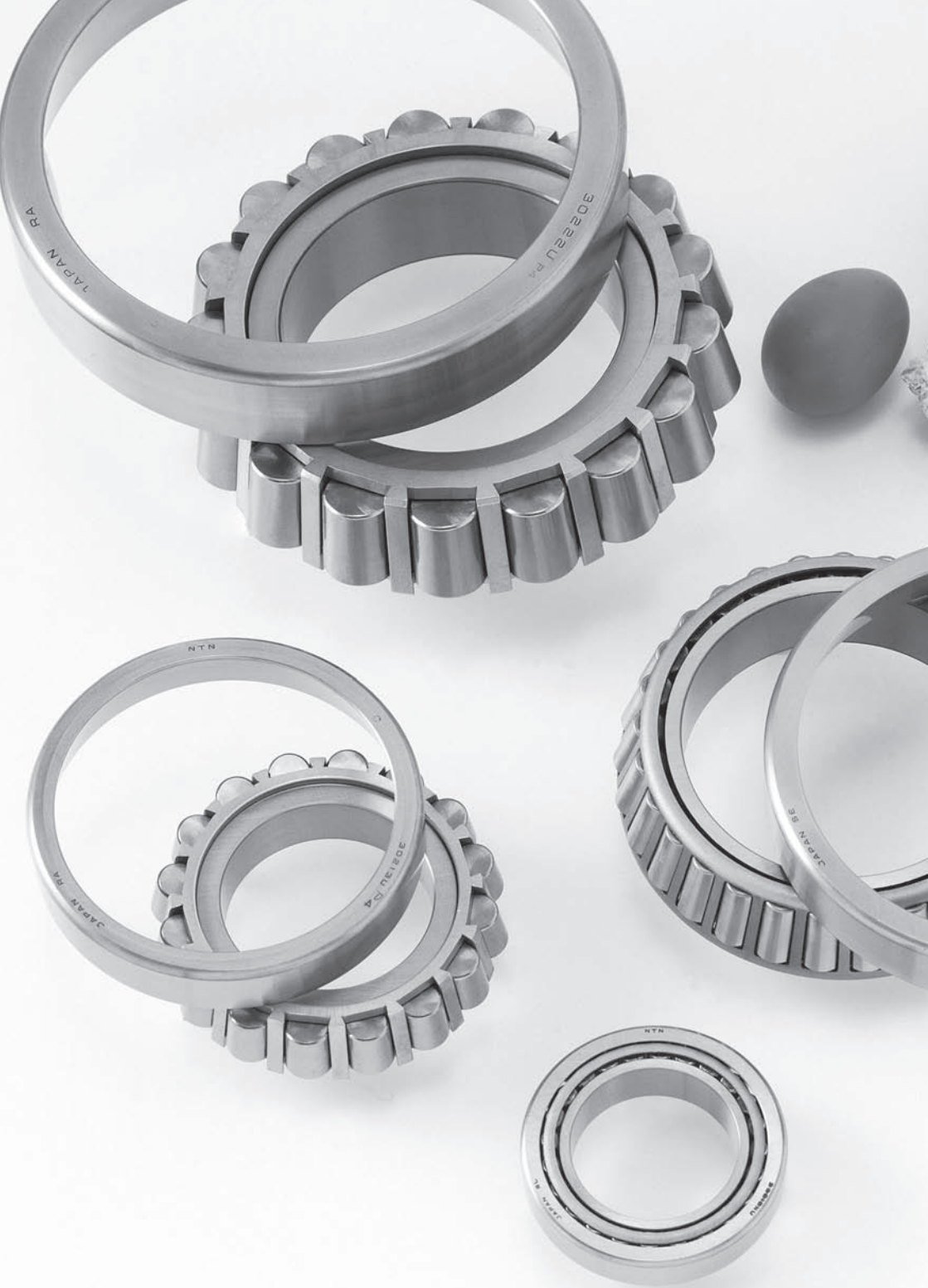
**Dynamic equivalent axial load**

$$P_{0a}=F_a$$

**Static equivalent axial load**

$$P_{00a}=F_a$$

Load center mm	Internal free space cm <sup>3</sup>	Mass kg	Reference dimensions mm		Abutment and fillet dimensions mm				Part number
			$d_1$	$D_2$	$d_a$ min	$D_b$ max	$r_{as}$ max	$r_{1as}$ max	
2a	Two row (approx.)	Two row (approx.)							
69.2	9	0.22	60.7	73.1	57.5	74.0	1	0.6	5S-HTA010UDB
77.7	13	0.36	68.2	80.7	65.0	84.0	1	0.6	5S-HTA011UDB
81.9	13	0.39	73.2	85.7	70.0	89.0	1	0.6	5S-HTA012UDB
86.1	14	0.41	78.2	90.7	75.0	94.0	1	0.6	5S-HTA013UDB
94.0	18	0.57	85.3	99.0	80.0	104	1	0.6	5S-HTA014UDB
98.2	19	0.60	90.3	104.0	85.0	109	1	0.6	5S-HTA015UDB
106.7	26	0.83	97.4	112.4	90.0	119	1	0.6	5S-HTA016UDB
110.9	28	0.87	102.4	117.4	95.0	124	1	0.6	5S-HTA017UDB
119.5	38	1.15	109.4	125.8	102	132.5	1.5	1	5S-HTA018UDB
123.7	39	1.20	114.4	130.8	107	137.5	1.5	1	5S-HTA019UDB
128.0	39	1.26	119.5	135.9	112	142.5	1.5	1	5S-HTA020UDB
136.5	49	1.64	126.5	144.2	119	152.5	2	1	5S-HTA021UDB
145.1	66	2.00	133.1	153.3	124	162.5	2	1	5S-HTA022UDB
153.6	67	2.17	143.3	163.4	134	172.5	2	1	5S-HTA024UDB
170.8	108	3.13	156.4	181.6	144	192.5	2	1	5S-HTA026UDB



## Main Spindle Bearings

### 12. Tapered Roller Bearings CONTENTS

<b>12. Tapered Roller Bearings</b> .....	268~273
① <b>Load calculation</b> .....	268
② <b>Bearing designation</b> .....	268
③ <b>Accuracy</b> .....	269
④ <b>Recommended fit for high-precision tapered roller bearings</b> .....	269
⑤ <b>Dimension tables</b> .....	270



## 12. Tapered Roller Bearings

Tapered roller bearings are designed so that the apexes of the inner ring, outer ring, and rollers are located at a common point on the bearing center line. Accordingly, the rollers roll on the raceway surfaces and slide along the back rib of the inner ring cone, guided by the resultant force from the inner ring and outer ring raceways.

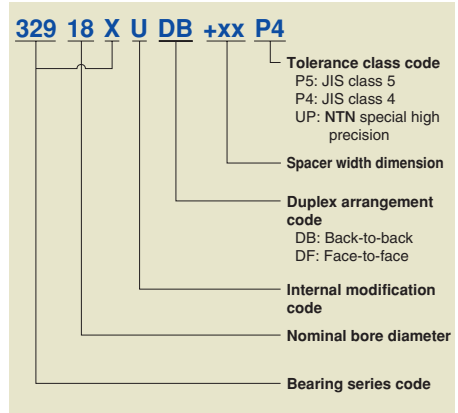
This bearing is suitable for handling a radial load, an axial load in one direction, and the resultant load. Also, it has a large load capacity.

In general, the cage of a tapered roller bearing is a punched steel plate type. If P4 or higher is needed for running accuracy, NTN recommends that a high-strength machined brass cage to be used.

### ① Load calculation

Tapered roller bearings are generally used in pairs, so their dynamic equivalent load can be calculated according to **Table 12.1**.

### ② Bearing designations



**Table 12.1 Bearing arrangement and equivalent load**

Bearing arrangement	Load condition	Axial load	Equivalent radial load
DB arrangement 	$\frac{0.5F_{rI}}{Y_I} \leq \frac{0.5F_{rII}}{Y_{II}} + F_a$	$F_{aI} = \frac{0.5F_{rI}}{Y_{II}} + F_a$ $F_{aII} = \frac{0.5F_{rII}}{Y_{II}}$	$P_{rI} = XF_{rI} + Y_I \left( \frac{0.5F_{rI}}{Y_{II}} + F_a \right)$ $P_{rII} = F_{rII}$
DF arrangement 	$\frac{0.5F_{rI}}{Y_I} > \frac{0.5F_{rII}}{Y_{II}} + F_a$	$F_{aI} = \frac{0.5F_{rI}}{Y_I}$ $F_{aII} = \frac{0.5F_{rI}}{Y_I} - F_a$	$P_{rI} = F_{rI}$ $P_{rII} = XF_{rII} + Y_{II} \left( \frac{0.5F_{rI}}{Y_I} - F_a \right)$
DB arrangement 	$\frac{0.5F_{rII}}{Y_{II}} \leq \frac{0.5F_{rI}}{Y_I} + F_a$	$F_{aI} = \frac{0.5F_{rI}}{Y_I}$ $F_{aII} = \frac{0.5F_{rI}}{Y_I} + F_a$	$P_{rI} = F_{rI}$ $P_{rII} = XF_{rII} + Y_{II} \left( \frac{0.5F_{rI}}{Y_I} + F_a \right)$
DF arrangement 	$\frac{0.5F_{rII}}{Y_{II}} > \frac{0.5F_{rI}}{Y_I} + F_a$	$F_{aI} = \frac{0.5F_{rII}}{Y_{II}} - F_a$ $F_{aII} = \frac{0.5F_{rII}}{Y_{II}}$	$P_{rI} = XF_{rI} + Y_I \left( \frac{0.5F_{rII}}{Y_{II}} - F_a \right)$ $P_{rII} = F_{rII}$

Note 1: The above are valid when the bearing internal clearance and preload are zero.

2: Radial forces in the opposite direction to the arrow in the above illustration are also regarded as positive.



### ③ Accuracy

Table 12.2 Inner rings

Unit:  $\mu\text{m}$

Nominal bore diameter $d$		Deviation of mean bore diameter in a single plane $d_{mp}$				Variation of bore diameter in a single plane $V_{dsp}$		Mean bore diameter deviation $V_{dmp}$		Radial runout $K_{ia}$		Perpendicularity of inner ring face with respect to the bore $S_d$		Axial runout $S_{ia}$		Width variation $B_s$		Deviation of the actual bearing width $T_s$	
over	incl.	Class 5		Class 4 ①		Class 5		Class 4		Class 5		Class 4		Class 4		Class 5		Class 4	
mm		high	low	high	low	max		max		max		max		max		high	low	high	low
18	30	0	-8	0	-6	6	5	5	4	5	3	8	4	4	0	-200	+200	-200	
30	50	0	-10	0	-8	8	6	5	5	6	4	8	4	4	0	-240	+200	-200	
50	80	0	-12	0	-9	9	7	6	5	7	4	8	5	4	0	-300	+200	-200	
80	120	0	-15	0	-10	11	8	8	5	8	5	9	5	5	0	-400	+200	-200	
120	180	0	-18	0	-13	14	10	9	7	11	6	10	6	7	0	-500	+350	-250	
180	250	0	-22	0	-15	17	11	11	8	13	8	11	7	8	0	-600	+350	-250	

① The tolerance of bore diameter deviation  $d_{is}$  applicable to class 4 is the same as the tolerance of single plane mean bore diameter deviation  $d_{amp}$ .

Table 12.3 Outer rings

Unit:  $\mu\text{m}$

Nominal bore diameter $D$		Deviation of mean outside diameter in a single plane $D_{mp}$				Variation of outside diameter in a single plane $V_{Dsp}$		Mean single plane outside diameter variation $V_{Dmp}$		Radial runout $K_{ea}$		Perpendicularity of outer ring outside surface with respect to the face $S_D$		Axial runout $S_{ea}$	
over	incl.	Class 5		Class 4 ②		Class 5		Class 4		Class 5		Class 4		Class 4	
mm		high	low	high	low	max		max		max		max		max	
30	50	0	-9	0	-7	7	5	5	5	7	5	8	4	5	5
50	80	0	-11	0	-9	8	7	6	5	8	5	8	4	5	5
80	120	0	-13	0	-10	10	8	7	5	10	6	9	5	6	6
120	150	0	-15	0	-11	11	8	8	6	11	7	10	5	7	7
150	180	0	-18	0	-13	14	10	9	7	13	8	10	5	8	8
180	250	0	-20	0	-15	15	11	10	8	15	10	11	7	10	10
250	315	0	-25	0	-18	19	14	13	9	18	11	13	8	10	10

② The tolerance of outside diameter deviation  $d_{is}$  applicable to class 4 is the same as the tolerance of single plane mean outside diameter deviation  $d_{mp}$ .

### ④ Recommended fit for high-precision tapered roller bearings

Table 12.4 Fit to shaft

Unit:  $\mu\text{m}$

Nominal bore diameter $d$		Fit between inner ring and shaft	
		Fixed side	Floating side
		Targeted ① interference	Targeted ① interference
over	incl.		
18	30	0~5T	0~1T
30	50	0~6T	0~2T
50	80	0~7T	0~3T
80	120	0~8T	0~4T
120	180	0~10T	0~5T
180	250	0~13T	0~6T
250	315	0~15T	0~6T
315	400	0~18T	0~8T

① Target the median value.  
T: Tight (Interference)

Table 12.5 Fit to housing

Unit:  $\mu\text{m}$

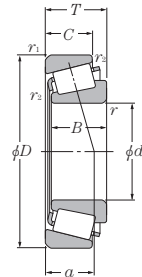
Nominal bore diameter $D$		Fit between outer ring and housing
over	incl.	
mm		Targeted interference ①
30	50	3L~3T
50	80	3L~3T
80	120	4L~4T
120	150	5L~5T
150	180	5L~5T
180	250	6L~6T
250	315	7L~7T
315	400	8L~8T
400	500	9L~9T

For precision main spindles, the tight (interference) side of the targeted interference is recommended for the precision tool side.

## ⑤ Dimension tables for tapered roller bearings

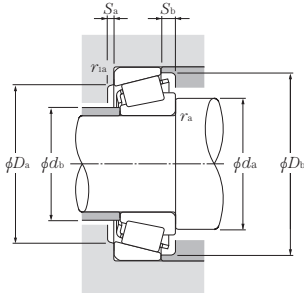
### Tapered Roller Bearings

d 20~95mm



part number	Boundary dimensions								Basic load ratings				Limiting speed	
	mm								dynamic kN		dynamic kgf		min <sup>-1</sup>	
	d	D	T	B	C	r <sub>3s</sub> min <sup>①</sup>	r <sub>1s</sub> min <sup>①</sup>	r <sub>2s</sub> min <sup>①</sup>	C <sub>r</sub>	C <sub>0r</sub>	C <sub>r</sub>	C <sub>0r</sub>	grease lubrication	oil lubrication
4T-32004X	20	42	15	15	12	0.6	0.6	0.15	24.9	27.9	2 540	2 840	9 500	13 000
4T-32005X	25	47	15	15	11.5	0.6	0.6	0.15	27.8	33.5	2 830	3 450	7 900	11 000
4T-32006X	30	55	17	17	13	1	1	0.3	37.5	46.0	3 800	4 700	6 900	9 200
4T-32007X	35	62	18	18	14	1	1	0.3	41.5	52.5	4 250	5 350	6 100	8 100
4T-32008X	40	68	19	19	14.5	1	1	0.3	50.0	65.5	5 100	6 650	5 300	7 100
4T-32009X	45	75	20	20	15.5	1	1	0.3	57.5	76.5	5 850	7 800	4 800	6 400
32910XU	50	72	15	15	12	0.6	0.6	0.15	35.5	57.0	3 650	5 800	4 700	6 300
4T-32010X	50	80	20	20	15.5	1	1	0.3	62.5	88.0	6 400	9 000	4 400	5 800
32911XU	55	80	17	17	14	1	1	0.3	44.5	73.5	4 550	7 500	4 300	5 700
4T-32011X	55	90	23	23	17.5	1.5	1.5	0.6	80.5	118	8 200	12 000	4 000	5 400
32912XA	60	85	17	17	14	1	1	0.3	51.0	83.0	5 200	8 450	4 000	5 300
4T-32012X	60	95	23	23	17.5	1.5	1.5	0.6	82.0	123	8 350	12 500	3 700	4 900
32913XU	65	90	17	17	14	1	1	0.3	48.5	85.0	4 900	8 700	3 700	4 900
4T-32013X	65	100	23	23	17.5	1.5	1.5	0.6	83.0	128	8 450	13 000	3 400	4 600
32914XU	70	100	20	20	16	1	1	0.3	68.5	110	7 000	11 200	3 400	4 600
4T-32014X	70	110	25	25	19	1.5	1.5	0.6	105	160	10 700	16 400	3 200	4 200
32915XU	75	105	20	20	16	1	1	0.3	69.5	114	7 100	11 600	3 200	4 300
32015XU	75	115	25	25	19	1.5	1.5	0.6	106	167	10 800	17 000	3 000	4 000
32916XU	80	110	20	20	16	1	1	0.3	72.0	121	7 350	12 400	3 000	4 000
32016XU	80	125	29	29	22	1.5	1.5	0.6	139	216	14 200	22 000	2 800	3 700
32917XU	85	120	23	23	18	1.5	1.5	0.6	94.0	157	9 600	16 100	2 800	3 800
32017XU	85	130	29	29	22	1.5	1.5	0.6	142	224	14 400	22 900	2 600	3 500
32918XU	90	125	23	23	18	1.5	1.5	0.6	97.5	168	9 950	17 100	2 700	3 600
32018XU	90	140	32	32	24	2	1.5	0.6	168	270	17 200	27 600	2 500	3 300
32919XU	95	130	23	23	18	1.5	1.5	0.6	101	178	10 300	18 200	2 500	3 400
32019XU	95	145	32	32	24	2	1.5	0.6	171	280	17 500	28 600	2 300	3 100

① Minimum allowable value for chamfer dimension r<sub>1</sub>, r<sub>2</sub> or r<sub>3</sub>.



### Dynamic equivalent radial load

$$P_r = XF_r + YF_a$$

$\frac{F_a}{F_r} \leq e$		$\frac{F_a}{F_r} > e$	
X	Y	X	Y
1	0	0.4	$Y_2$

### Static equivalent radial load

$$P_{or} = 0.5F_r + Y_0F_a$$

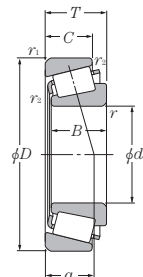
Note that when  $P_{or} < F_r$ ,  $P_{or} = F_r$ .

The values for  $e$ ,  $Y_2$  and  $Y_0$  are given in the table below.

Abutment and fillet dimensions										Load center mm	Factor	Axial load factor		Mass kg (approx.)
mm												$a$	$e$	
$d_a$ min	$d_b$ max	$D_a$ max	$D_b$ min	$S_a$ min	$S_b$ min	$r_{as}$ max	$r_{ias}$ max							
24.5	25	37.5	36	39	3	3	0.6	0.6	10.5	0.37	1.60	0.88	0.097	
29.5	30	42.5	40	44	3	3.5	0.6	0.6	12	0.43	1.39	0.77	0.114	
35.5	35	49.5	48	52	3	4	1	1	13.5	0.43	1.39	0.77	0.166	
40.5	40	56.5	54	59	4	4	1	1	15.5	0.45	1.32	0.73	0.224	
45.5	46	62.5	60	65	4	4.5	1	1	15	0.38	1.58	0.87	0.273	
50.5	51	69.5	67	72	4	4.5	1	1	16.5	0.39	1.53	0.84	0.346	
54.5	54	67.5	63.5	69	3	3	0.6	0.6	13.5	0.34	1.76	0.97	1.191	
55.5	56	74.5	72	77	4	4.5	1	1	17.5	0.42	1.42	0.78	0.366	
60.5	60.5	74.5	70.5	76.5	3	3	1	1	14.5	0.31	1.94	1.07	0.274	
63.5	63	81.5	81	86	4	5.5	1.5	1.5	20	0.41	1.48	0.81	0.563	
65.5	65.5	79.5	76.5	82	3	3	1	1	15.5	0.33	1.80	0.99	0.296	
68.5	67	86.5	85	91	4	5.5	1.5	1.5	21	0.43	1.39	0.77	0.576	
70.5	70	84.5	80	86.5	3	3	1	1	16.5	0.35	1.70	0.93	0.315	
73.5	72	91.5	90	97	4	5.5	1.5	1.5	22.5	0.46	1.31	0.72	0.63	
75.5	75	94.5	90	96	4	4	1	1	18	0.32	1.90	1.05	0.487	
78.5	78	101.5	98	105	5	6	1.5	1.5	24	0.43	1.38	0.76	0.848	
80.5	80	99.5	94	101.5	4	4	1	1	19	0.33	1.80	0.99	0.511	
83.5	83	106.5	103	110	5	6	1.5	1.5	25.5	0.46	1.31	0.72	0.909	
85.5	85	104.5	99	106.5	4	4	1	1	20	0.35	1.71	0.94	0.54	
88.5	89	116.5	112	120	6	7	1.5	1.5	27	0.42	1.42	0.78	1.28	
93.5	92	111.5	111	115	4	5	1.5	1.5	21	0.33	1.83	1.01	0.733	
93.5	94	121.5	117	125	6	7	1.5	1.5	28.5	0.44	1.36	0.75	1.35	
98.5	96	116.5	112.5	120.5	4	5	1.5	1.5	22	0.34	1.75	0.96	0.817	
100	100	131.5	125	134	6	8	2	1.5	30	0.42	1.42	0.78	1.79	
103.5	101	121.5	117	125.5	4	5	1.5	1.5	23.5	0.36	1.68	0.92	0.851	
105	105	136.5	130	140	6	8	2	1.5	31.5	0.44	1.36	0.75	1.83	

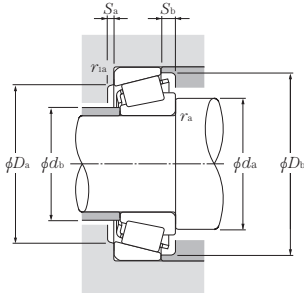
## Tapered Roller Bearings

$d$  100~190mm



part number	Boundary dimensions								Basic load ratings				Limiting speed	
	mm								dynamic kN	static	dynamic kgf	static	min <sup>-1</sup>	
	$d$	$D$	$T$	$B$	$C$	$r_{1s}$ min <sup>①</sup>	$r_{1s}$ min <sup>①</sup>	$r_{2s}$ min <sup>①</sup>	$C_r$	$C_{or}$	$C_r$	$C_{or}$	grease lubrication	oil lubrication
32920XU	100	140	25	25	20	1.5	1.5	0.6	121	206	12 300	21 000	2 400	3 200
32020XU	100	150	32	32	24	2	1.5	0.6	170	281	17 300	28 600	2 200	3 000
32921XA	105	145	25	25	20	1.5	1.5	0.6	126	219	12 800	22 400	2 300	3 000
32021XU	105	160	35	35	26	2.5	2	0.6	201	335	20 500	34 000	2 100	2 800
32922XA	110	150	25	25	20	1.5	1.5	0.6	127	226	13 000	23 100	2 200	2 900
32022XU	110	170	38	38	29	2.5	2	0.6	236	390	24 000	39 500	2 000	2 700
32924XU	120	165	29	29	23	1.5	1.5	0.6	162	294	16 500	30 000	2 000	2 600
32024XU	120	180	38	38	29	2.5	2	0.6	245	420	25 000	43 000	1 800	2 500
32926XU	130	180	32	32	25	2	1.5	0.6	194	350	19 800	36 000	1 800	2 400
32026XU	130	200	45	45	34	2.5	2	0.6	320	545	32 500	55 500	1 700	2 200
32928XU	140	190	32	32	25	2	1.5	0.6	200	375	20 400	38 000	1 700	2 200
32028XU	140	210	45	45	34	2.5	2	0.6	330	580	33 500	59 500	1 600	2 100
32930XU	150	210	38	38	30	2.5	2	0.6	268	490	27 300	50 000	1 600	2 100
32030XU	150	225	48	48	36	3	2.5	1	370	655	37 500	67 000	1 400	1 900
32932XU	160	220	38	38	30	2.5	2	0.6	276	520	28 200	53 000	1 500	1 900
32032XU	160	240	51	51	38	3	2.5	1	435	790	44 500	80 500	1 400	1 800
32934XU	170	230	38	38	30	2.5	2	0.6	286	560	29 200	57 000	1 400	1 800
32034XU	170	260	57	57	43	3	2.5	1	500	895	51 000	91 000	1 300	1 700
32936XU	180	250	45	45	34	2.5	2	0.6	350	700	36 000	71 500	1 300	1 700
32938XU	190	260	45	45	34	2.5	2	0.6	355	710	36 000	72 000	1 200	1 600

① Minimum allowable value for chamfer dimension  $r_1$ ,  $r_2$  or  $r_s$ .



### Dynamic equivalent radial load

$$P_r = XF_r + YF_a$$

$\frac{F_a}{F_r} \leq e$		$\frac{F_a}{F_r} > e$	
X	Y	X	Y
1	0	0.4	$Y_2$

### Static equivalent radial load

$$P_{0r} = 0.5F_r + Y_0F_a$$

Note that when  $P_{0r} < F_r$ ,  $P_{0r} = F_r$ .

The values for  $e$ ,  $Y_2$  and  $Y_0$  are given in the table below.

Abutment and fillet dimensions									Load center mm	Factor	Axial load factor		Mass kg (approx.)
mm											$a$	$e$	
$d_a$ min	$d_b$ max	$D_a$ max	$D_b$ min	$S_a$ min	$S_b$ min	$r_{as}$ max	$r_{1as}$ max						
108.5	107.5	131.5	127.5	135.5	4	5	1.5	1.5	24.5	0.33	1.82	1.00	1.14
110	109	141.5	134	144	6	8	2	1.5	32.5	0.46	1.31	0.72	1.91
113.5	113.5	136.5	131.5	140.5	5	5	1.5	1.5	25	0.34	1.76	0.97	1.2
117	116	150	143	154	6	9	2	2	34.5	0.44	1.35	0.74	2.42
118.5	117.5	141.5	137	145.5	5	5	1.5	1.5	26.5	0.36	1.69	0.93	1.23
122	122	160	152	163	7	9	2	2	36.5	0.43	1.39	0.77	3.07
128.5	128.5	156.5	150	160	6	6	1.5	1.5	29.5	0.35	1.72	0.95	1.77
132	131	170	161	173	7	9	2	2	39	0.46	1.31	0.72	3.25
140	139	171.5	163.5	174	6	7	2	1.5	31.5	0.34	1.77	0.97	2.36
142	144	190	178	192	8	11	2	2	43.5	0.43	1.38	0.76	4.96
150	150	181.5	177	184	6	6	2	1.5	34	0.36	1.67	0.92	2.51
152	153	200	187	202	8	11	2	2	46	0.46	1.31	0.72	5.28
162	162	200	192	202	7	8	2	2	36.5	0.33	1.83	1.01	3.92
164	164	213	200	216	8	12	2.5	2	49.5	0.46	1.31	0.72	6.37
172	170.5	210	199	213.5	7	8	2	2	38.5	0.35	1.73	0.95	4.15
174	175	228	213	231	8	13	2.5	2	52.5	0.46	1.31	0.72	7.8
182	183	220	213	222	7	8	2	2	42.5	0.38	1.57	0.86	4.4
184	187	248	230	249	10	14	2.5	2	56	0.44	1.35	0.74	10.5
192	193	240	225	241	8	11	2	2	54	0.48	1.25	0.69	6.54
202	204	250	235	251	8	11	2	2	55	0.48	1.26	0.69	6.77



## Ball Screw Support Bearings

### 13. Ball Screw Support Bearings CONTENTS

<b>13. Ball Screw Support Bearings</b> .....	276~305
① Angular contact thrust ball bearings 2A-BST series .....	276
② Double row thrust angular contact ball bearing unit BSTU .....	279
③ Duplex angular contact ball bearings HT series .....	280
④ Needle roller bearings with double-row thrust needle roller bearings AXN series .....	280
Needle roller bearings with double-row thrust cylindrical roller bearings ARN series .....	280
⑤ Bearing designations .....	281
⑥ Bearing precision .....	282
⑦ Basic preload and axial rigidity .....	286
⑧ Shaft and housing fit .....	287
⑨ Applications .....	287
⑩ Starting torque of BST type .....	288
⑪ Recommended lubrication specifications .....	289
⑫ Dimension tables	
Angular contact thrust ball bearings	
BST and BST LXL series .....	290
2A-BST and 2A-BST LXL series .....	292
Double row thrust angular contact ball bearing unit	
BSTU LLX series .....	296
Duplex angular contact ball bearings HT series .....	300
Needle roller bearings with double-row thrust needle roller bearings	
AXN , ARN series .....	302



## 13. Ball Screw Support Bearings

NTN ballscrew bearings are optimized to support a ballscrew. These bearings are categorized as shown in **Table 13.1**.

**Table 13.1 Bearing types**

Type code	Notes	Bore diameter
<b>BST</b> <b>2A-BST</b>	Open type thrust angular contact ball bearing with 60° contact angle, generally used with grease lubrication	$\phi 17 \sim \phi 60$
<b>BST LXL/L588</b> <b>2A-BST LXL/L588</b>	Grease-lubricated sealed angular contact ball bearing with 60° contact angle	$\phi 17 \sim \phi 60$
<b>BSTU LLX/L588</b>	Grease-lubricated sealed double row thrust angular contact ball bearing unit with 60° contact angle	$\phi 20 \sim \phi 100$
<b>HT</b>	Duplex angular contact ball bearing with 30° contact angle, generally used with grease lubrication	$\phi 6 \sim \phi 40$
<b>AXN</b>	Needle roller bearing with double-direction thrust needle roller bearing, generally used with oil lubrication	$\phi 20 \sim \phi 50$
<b>ARN</b>	Needle roller bearing with double-direction thrust cylindrical roller bearing, generally used with oil lubrication	$\phi 20 \sim \phi 70$

### ① **ULTAGE** Angular contact thrust ball bearings BST-1B (LXL/L588), 2A-BST-1B (LXL/L588) series

The 2A-BST type incorporates the maximum possible number of small balls (compared with those of a standard bearing), has thicker inner and outer rings, and a larger contact angle of 60°. Thus, this type of bearing boasts greater axial rigidity. Additionally, since balls are used as the rolling elements, the starting torque of an angular contact thrust ball bearing is less than that of a roller bearing.

Open (BST and 2A-BST type) and light-contact seals (BST LXL and 2A-BST LXL type) are available and molded resin cages are standard.

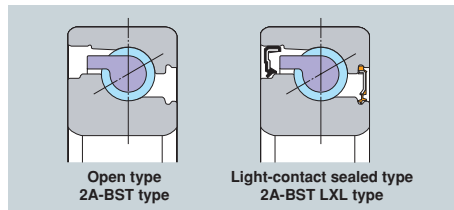
Side faces of BST type bearings are flush-ground to provide the same face height difference for both the front and back faces. As a result, bearings of the same part number can be freely combined into DB, DBT, DTBT configurations as illustrated in **Fig. 13.2**, and the adjustment for a relevant preload is no longer necessary.

Every single bearing is machined to the same face height so that when any arrangement is installed on a ballscrew the unit has optimal preload. For this reason, no time-consuming preload adjustment (adjustment with shims or tightening and loosening while measuring the starting torque) is necessary.

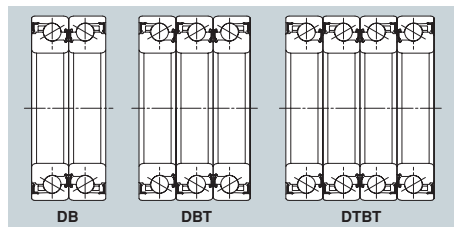
#### ■ **Features 2A-BST-1B (LXL/L588)**

1. Unique heat treatment greatly improves resistance against rolling contact fatigue, leading to longer service life (approximately two times that of the conventional type).
2. Both sides are sealed to enhance contamination resistance and to preserve the grease. (Light-contact seal type)

3. Special long-life grease is used. (Light-contact seal type)
4. The combination of a unique heat treatment and special grease reduces fretting (by 80% or more for sliding mode, 90% or more for rolling mode, compared to the conventional type). (Light-contact seal type)
5. Pre-greased bearings eliminate the need for further grease packing and allow easier handling. (Light-contact seal type)



**Fig. 13.1**



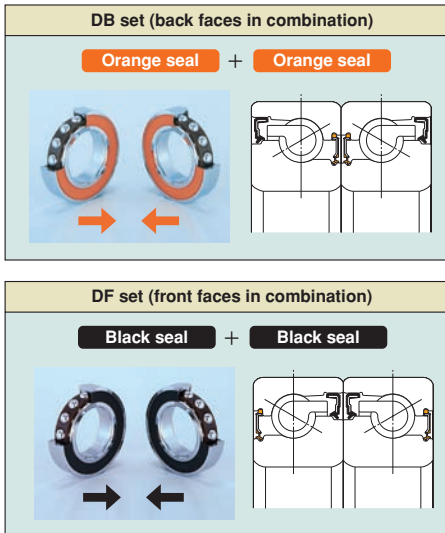
**Fig. 13.2 Bearing arrangement**



**Easy handling**

2A-BST LXL type and BST LXL grease-lubricated sealed angular contact ball bearings eliminate the need for grease filling because they have been packed with grease in advance. You need to only wipe away rust preventive oil before use. Seals in different colors are used for the front and back sides.

The front side (black) and back side (orange) can be identified by the color of a seal, and you can easily check configuration during assembly.



**Performance tests 2A-BST-1B (LXL/L588)**

Ball screw support bearings have a unique internal design in order to lengthen service life and enhance resistance to fretting.

**(1) Fretting resistance test (sliding)**

Resistance to fretting while sliding is tested by the fretting resistance test. A conceptual drawing of the test is shown in Fig. 13.3, and the test conditions are shown in Table 13.3. In this test, a fixed ball is pushed against a plate, and reciprocated for a fixed period. The volume of ball and plate wear depth are checked after testing as shown in Fig. 13.4.

Due to a unique heat treatment and special grease (light-contact seal type), amount of wear is reduced to 1/5 or less compared to the conventional type consisting of standard SUJ2 plate material and lithium-based general purpose grease. (Fig. 13.4)

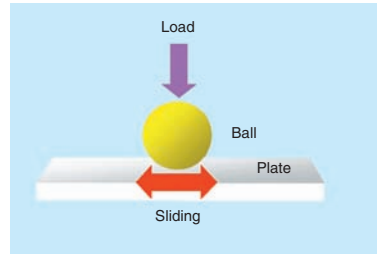


Fig. 13.3 Fretting resistance test (sliding)

Table 13.3 Test conditions

Material	Plate	Conventional type (SUJ2 without special heat treatment)
	Ball	ULTRAGE series (SUJ2 with special heat treatment)
Load (N)		SUJ2
Max. contact surface pressure (MPa)		98
Loading frequency ( $\times 10^5$ cycle)		2560
Sliding cycle (Hz)		Test time: 8 h
Amplitude (mm)		30
Lubrication		0.47
Temperature		Grease
		Room temperature

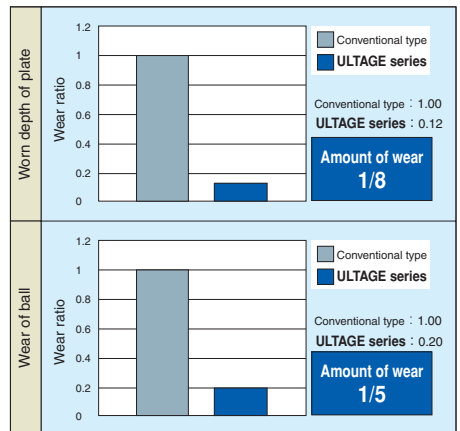


Fig. 13.4 Ratio of fretting corrosion in sliding mode

**(2) Fretting resistance test (rolling)**

Resistance against fretting while rolling is tested in the rotating and oscillating type fretting corrosion test. A conceptual drawing of the test is shown in Fig. 13.5, and the test conditions are shown in Table 13.4. In this test, a housing plate is fixed, and the shaft plate oscillates. The decrease in the weight of the bearing plate after the test is shown in Fig. 13.6.

Due to the combination of a unique heat treatment and a special grease (light-contact seal type), the amount of wear is reduced to 1/10 or less compared to the conventional type consisting of standard SUJ2 steel rings and lithium based general purpose grease. (Fig. 13.6).

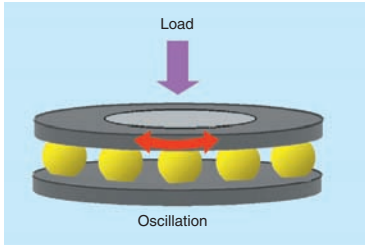


Fig. 13.5 Fretting resistance test (rolling)

Table 13.4 Test conditions

Bearing (mm)	Evaluated with thrust ball bearing 51204 ( $\phi 20 \times \phi 40 \times 14$ )
Load (kN)	2.5
Max. contact surface pressure (MPa)	1700
Test time (h)	8
Oscillating cycle (Hz)	30
Oscillating angle (deg)	12
Lubrication	Grease
Temperature	Room temperature

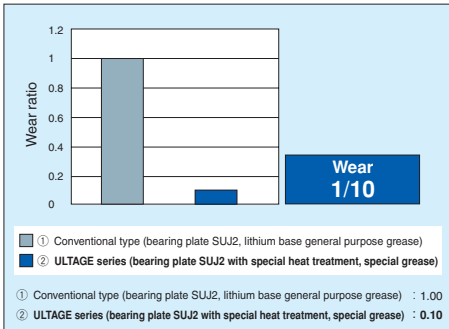


Fig. 13.6 Ratio of fretting corrosion while rolling

**(3) Rolling contact fatigue life test**

Resistance to rolling contact fatigue is improved as a result of a special heat treatment, leading to a longer service life compared to the standard heat-treated type model in both clean and contaminated oil. (Fig. 13.7)

Table 13.5 Test conditions

Bearing (mm)	Evaluated with deep groove ball bearing 6206 ( $\phi 30 \times \phi 62 \times 16$ )
Radial load (kN)	6.86
Shaft speed (min <sup>-1</sup> )	2000
Lubrication	VG56 turbine oil
Atmosphere temperature (°C)	60

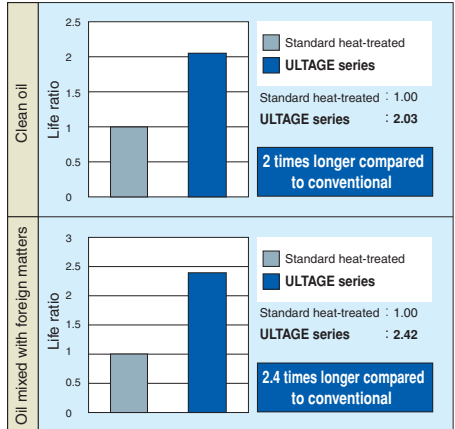


Fig. 13.7 Effect of special heat treatment on rolling contact fatigue life

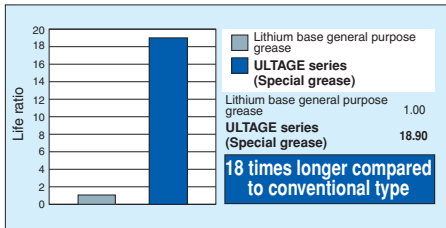
**(4) Grease life test**

Service life of the grease has been dramatically extended compared to lithium-base general purpose grease (Fig. 13.8).

(Special grease is available for only the light-contact seal type.)

**Table 13.6 Test conditions**

Bearing (mm)	Evaluated with deep groove ball bearing 6204 ( $\phi 20 \times \phi 47 \times 14$ )
Radial load (N)	67
Axial load (N)	67
Shaft speed (min <sup>-1</sup> )	10000
Atmosphere temperature (°C)	150



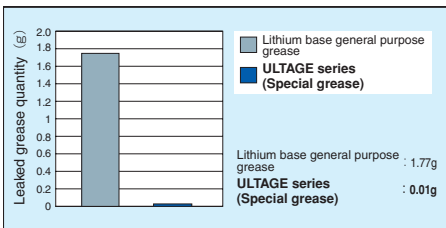
**Fig. 13.8 Grease life ratio**

**(5) Grease leakage test**

Light-contact type seals eliminate grease leakage from the bearing. (Fig. 13.9)

**Table 13.7 Test conditions**

Bearing (mm)	2A-BST40×72-1BDFP4 ( $\phi 40 \times \phi 72 \times 15 \times 2$ rows)
Axial load (kN)	3.9
Shaft speed (min <sup>-1</sup> )	1000, 2000, 3000 running for two hours for each step
Atmosphere	Room temperature



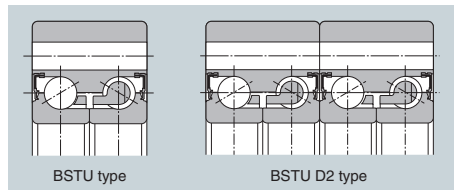
**Fig. 13.9 Grease leakage**

**② ULTAGE Double row thrust angular contact ball bearing unit BSTU**

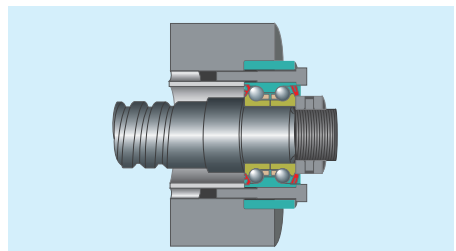
The BSTU type is ball screw support bearing unit with two inner rings and one outer ring, in a back-to-back duplex arrangement. The outer ring has mounting holes for the housing for easier handling and the use of a newly developed seal ensures low torque and high dust resistance.

**■ Features**

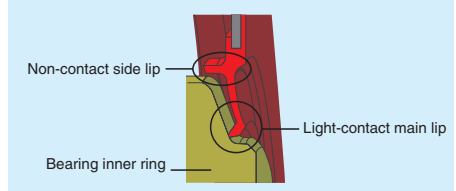
- Greater load capacity with optimizations made to the internal bearing design.
- Use of newly developed light-contact seal to achieve both low torque and high dust resistance.
- The long operating life of the BST type, and use of special grease with excellent fretting resistance.
- Outer ring mounting hole, and sealed grease lubrication groove for easier handling.
- Specifications combining two of these units (D2) are also available for high-load capacity applications.



**Fig. 13.10 BSTU**



**Fig. 13.11 Example of mounted BSTU type installation**



**Fig. 13.1 Light-contact seal (code L)**

**Performance tests**

**(1) Bearing operating test**

The BSTU type exhibit stable temperature rises up to 5000 min<sup>-1</sup> ( $d_{min}$  value  $0.225 \times 10^6$ ) due to optimizations made to the internal bearing design and the use of a newly developed light-contact seal. (Fig. 13.13)

**[Test conditions]**

Bearing (mm)	BSTU3080LLX/GNP4U/L588 (φ30Xφ80X28)
Shaft speed (min <sup>-1</sup> )	Max. 5000

The operating pattern at each shaft speed is shown to the right.

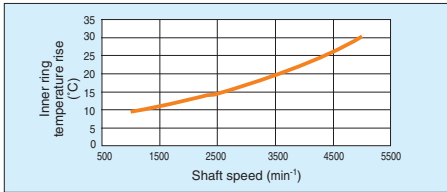
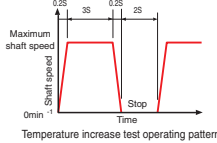


Fig. 13.13 Relation between shaft speed and temperature rise

**(2) Torque test, dust test**

The BSTU type limits starting torque and has better dust resistance with the use of a newly developed light-contact seal. (Fig. 13.14, Fig. 13.15)

**[Test conditions]**

Bearing (mm)	BSTU3080LLX/GNP4U/L588 (φ30Xφ80X28)
--------------	-------------------------------------

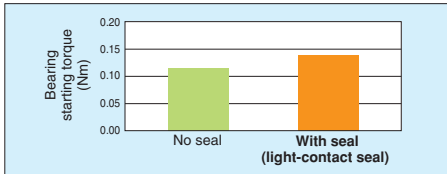
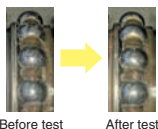


Fig. 13.14 Bearing starting torque

**[Test conditions]**

Bearing (mm)	BSTU3080LLX/GNP4U/L588 (φ30Xφ80X28)
Shaft speed (min <sup>-1</sup> )	2200
Dust particle diameter	5 to 75 μm (8 types of test powder 1 JIS Z8901)
Dust color phase	Brown
Test time	1 hour



Bearing internal conditions before and after test (with bearing outer ring removed) No foreign matter was observed inside the bearing after test.

Fig. 13.15 Dust test results

**③ Duplex angular contact ball bearings HT series**

HT type duplex angular contact ball bearings feature larger axial load capacity while maintaining the same dimensions as a standard angular contact ball bearing (contact angle: 30°). Bearings smaller than the BST type are available for use in small products.

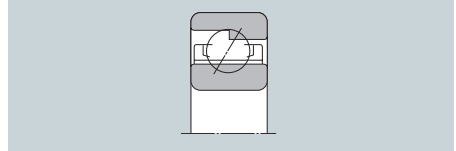


Fig. 13.10 HT

**④ Needle roller bearings with double-row thrust needle roller bearings AXN series**

**Needle roller bearings with double-row thrust cylindrical roller bearings ARN series**

AXN and ARN type bearings have thrust needle roller or thrust cylindrical roller bearings on both sides of a radial needle roller bearing. The outer ring side face of the radial needle roller bearing is used as the raceway of both thrust bearings. These bearings can withstand axial loads in both directions while maintaining compact designs. The radial needle roller bearings are suitable for heavy radial loads.

The axial rigidity of the AXN type is extremely enhanced since the thrust needle roller bearings are used for axial loads.

Likewise, the axial rigidity of the ARN type is improved. Since the axial load capacity of this type is larger than the AXN type, this type is suitable for heavy axial loads. Oil lubrication is recommended for the ARN type.

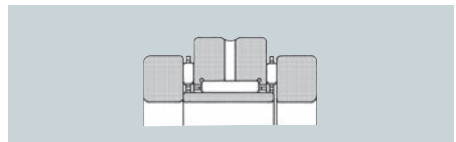


Fig. 13.11 AXN

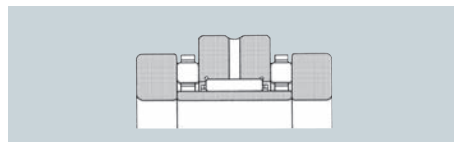


Fig. 13.12 ARN

## 5 Bearing designations

The part number for a ballscrew bearing consists of a type code, dimension code, and various suffixes.

### 2A-BST type

2A - BST 20 × 47 -1B LXL DBT P4 / L588

**Grease code**  
L588: Urea based special grease

**Tolerance class code**  
P5: JIS Class 5 (equivalent)  
P4: JIS Class 4 (equivalent)  
UP: NTN Class

**Arrangement code**

**Seal code**  
LXL: Light contact rubber seals

**Identification code**  
Preload code and added number  
-1B: Standard preload  
-11B: Light preload

**Outside diameter (mm)**

**Nominal bore diameter (mm)**

**Bearing type code**

**Heat treatment**

### HT type

7 0 04 HT DF / GM P4

**Tolerance class code**  
P5: JIS class 5  
P4: JIS class 4

**Internal clearance code**  
GM: Medium preload  
GH: Heavy preload

**Arrangement code**

**Internal design code**

**Nominal bore diameter**  
(See dimension tables.)

**Dimension series code**

**Bearing type code**

### AXN and ARN type

AXN 2052 P4

**Tolerance class code**  
P5: JIS Class 5  
P4: JIS Class 4

**Dimension**  
Bore diameter,  
outside diameter (mm)

**Bearing type code**  
AXN  
ARN

### BSTU type

BSTU 30 80 LLX (N) (DX) (D2) /GN P42U /L588

**Grease code**

**Tolerance class code**

**Preload code**

**Arrangement code**

**Outer ring re-lubricating hole**

**Outer ring pullout groove**

**Seal code**

**Outside diameter (mm)**

**Nominal bore diameter (mm)**

**Bearing type code**

⑤ Bearing precision

The precision of ballscrew bearings varies depending on the bearing type.

● **2A-BST type**

Available in NTN class 5 (tolerance class code P5), class 4 (tolerance class code P4) each complying with JIS standards, and grade UP (tolerance class code UP). The classes are listed in ascending order.

● **70HT type**

Same precision as the main spindle angular contact ball bearing. Classes 5 and 4 are available.

● **AXN, ARN types**

NTN standard classes 4 and 5 complying with the JIS standards.

■ Accuracy of 2A-BST type

Table 13.8 Inner rings

Unit:  $\mu\text{m}$

Nominal bore diameter $d$		Single plane mean bore diameter deviation $\Delta d_{mp}$						Width variation $VB_s$			Radial runout $K_{ia}$			Face runout with bore $S_a$			Axial runout $S_{ia}$			Width deviation $\Delta B_s$					
mm over	incl.	Class 5 high	Class 4 high	Class 4 <sup>①</sup> low	Class UP <sup>①</sup> high	Class UP <sup>①</sup> low	Class 5 max	Class 4 max	Class UP max	Class 5 max	Class 4 max	Class UP max	Class 5 max	Class 4 max	Class UP max	Class 5 max	Class 4 max	Class UP max	Class 5 high	Class 4 high	Class UP high	Class 5 low	Class 4 low	Class UP low	
10	18	0	-5	0	-4	0	-3.5	5	2.5	2	3.5	3	2	7	3	2	5	3	2	0	-120	0	-120	0	-100
18	30	0	-6	0	-5	0	-3.5	5	2.5	2	4	3	2	8	4	3	5	3	2	0	-120	0	-120	0	-100
30	50	0	-8	0	-6	0	-5	5	3	2	5	4	3	8	4	3	6	3	2	0	-120	0	-120	0	-100
50	80	0	-9	0	-7	0	-5	6	4	3	5	4	4	8	5	4	7	4	3	0	-150	0	-150	0	-150

① The tolerance of outside diameter deviation  $\Delta d_o$  applicable to classes 4 and UP is the same as the tolerance of single plane mean outside diameter deviation  $\Delta d_{mp}$ .

Table 13.9 Outer rings

Unit:  $\mu\text{m}$

Nominal bore diameter $d$		Single plane mean outside diameter deviation $\Delta d_{mp}$						Width variation $VC_s$			Radial runout $K_{ea}$			Outside surface inclination $S_D$			Axial runout $S_{ea}$			Width deviation $\Delta C_s$				
mm over	incl.	Class 5 high	Class 4 high	Class 4 <sup>①</sup> low	Class UP <sup>①</sup> high	Class UP <sup>①</sup> low	Class 5 max	Class 4 max	Class UP max	Class 5 max	Class 4 max	Class UP max	Class 5 max	Class 4 max	Class UP max	All classes	All classes	All classes	Class 5 high	Class 4 high	Class UP high	Class 5 low	Class 4 low	Class UP low
30	50	0	-7	0	-6	0	-5	5	2.5	2	7	5	4	8	4	3	Identical to $S_1$ relative to $d$ on the same bearing.	Identical to $\Delta B_s$ relative to $d$ on the same bearing.	0	-70	0	-70	0	-50
50	80	0	-9	0	-7	0	-5	6	3	2	8	5	4	8	4	3			0	-120	0	-120	0	-100
80	120	0	-10	0	-8	0	-7	8	4	3	10	6	4	9	5	4			0	-150	0	-150	0	-150

② The tolerance of outside diameter deviation  $\Delta d_o$  applicable to classes 4 and UP is the same as the tolerance of single plane mean outside diameter deviation  $\Delta d_{mp}$ .

■ Accuracy of BSTU type (Class P42U)

Table 13.10 Inner rings

Unit:  $\mu\text{m}$

Nominal bore diameter $d$ mm	Single plane mean bore diameter deviation $\Delta d_{mp}$		Single radial plane bore diameter variation $V_{dp}$	Mean bore diameter deviation $V_{dmp}$	Radial runout $K_{ia}$	Face runout with bore $S_d$	Axial runout $S_{ia}$	Width deviation $\Delta B_s$		Width variation $VB_s$
	high	low	max	max	max	max	max	high	low	max
	20	0	-5	2.5	2.5	3	4	2	0	-125
25	0	-5	2.5	2.5	3	4	2	0	-125	2
30	0	-5	2.5	2.5	3	4	2.5	0	-125	2.5
35	0	-5	2.5	2.5	4	4	2.5	0	-125	2.5
40	0	-5	2.5	2.5	4	4	2.5	0	-125	2.5
90	0	-8	4	4	5	5	3	0	-125	3
100	0	-8	4	4	5	5	3	0	-125	3

Table 13.11 Outer rings

Unit:  $\mu\text{m}$

Nominal outside diameter $D$ mm	Single plane mean outside diameter deviation $\Delta D_{mp}$		Single radial plane outside diameter deviation $V_{Dp}$	Mean single plane outside diameter deviation $V_{Dmp}$	Radial runout $K_{ea}$	Outside surface inclination $S_D$	Axial runout $S_{ea}$	Width variation $\Delta C_s$		Width deviation $VC_s$
	high	low	max	max	max	max	max	high	low	max
	68	0	-10	3.5	3.5	5	4	5	0	-250
75	0	-10	3.5	3.5	5	4	5	0	-250	3
80	0	-10	3.5	3.5	5	4	5	0	-250	3
90	0	-10	4	4	6	5	6	0	-250	4
100	0	-10	4	4	6	5	6	0	-250	4
190	0	-15	8	6	10	7	10	0	-250	7
200	0	-15	8	6	10	7	10	0	-250	7

■ Accuracy of BSTU type (Class P4U)

Table 13.12 Inner rings

Unit:  $\mu\text{m}$

Nominal bore diameter $d$ mm	Single plane mean bore diameter deviation $\Delta d_{mp}$		Single radial plane bore diameter variation $V_{dp}$	Mean bore diameter deviation $V_{dmp}$	Radial runout $K_{ia}$	Face runout with bore $S_d$	Axial runout $S_{ia}$	Width deviation $\Delta B_s$		Width variation $VB_s$
	high	low	max	max	max	max	max	high	low	max
	20	0	-5	2.5	2.5	3	4	4	0	-125
25	0	-5	2.5	2.5	3	4	4	0	-125	2.5
30	0	-5	2.5	2.5	3	4	4	0	-125	2.5
35	0	-5	2.5	2.5	4	4	4	0	-125	3
40	0	-5	2.5	2.5	4	4	4	0	-125	3
90	0	-8	4	4	5	5	5	0	-125	4
100	0	-8	4	4	5	5	5	0	-125	4

Table 13.13 Outer rings

Unit:  $\mu\text{m}$

Nominal outside diameter $D$ mm	Single plane mean outside diameter deviation $\Delta D_{mp}$		Single radial plane outside diameter deviation $V_{Dp}$	Mean single plane outside diameter deviation $V_{Dmp}$	Radial runout $K_{ea}$	Outside surface inclination $S_D$	Axial runout $S_{ea}$	Width variation $\Delta C_s$		Width deviation $VC_s$
	high	low	max	max	max	max	max	high	low	max
	68	0	-10	3.5	3.5	5	4	5	0	-250
75	0	-10	3.5	3.5	5	4	5	0	-250	3
80	0	-10	3.5	3.5	5	4	5	0	-250	3
90	0	-10	4	4	6	5	6	0	-250	4
100	0	-10	4	4	6	5	6	0	-250	4
190	0	-15	8	6	10	7	10	0	-250	7
200	0	-15	8	6	10	7	10	0	-250	7

Accuracy of HT type

Table 13.14 Inner rings

Nominal bore diameter $d$  mm over incl.	Single plane mean bore diameter deviation $d_{mp}$						Single radial plane bore diameter variation $V_{dP}$						Mean bore diameter deviation $V_{dmp}$			Inner ring radial runout $K_{ia}$		
	Class 5		Class 4 ①		Class 2 ②		Diameter series 9			Diameter series 0,2			Class 5 Class 4 Class 2			Class 5 Class 4 Class 2		
	high	low	high	low	high	low	Class 5	Class 4	Class 2	Class 5	Class 4	Class 2	Class 5	Class 4	Class 2	Class 5	Class 4	Class 2
2.5 10	0	-5	0	-4	0	-2.5	5	4	2.5	4	3	2.5	3	2	1.5	4	2.5	1.5
10 18	0	-5	0	-4	0	-2.5	5	4	2.5	4	3	2.5	3	2	1.5	4	2.5	1.5
18 30	0	-6	0	-5	0	-2.5	6	5	2.5	5	4	2.5	3	2.5	1.5	4	3	2.5
30 50	0	-8	0	-6	0	-2.5	8	6	2.5	6	5	2.5	4	3	1.5	5	4	2.5

- ① The tolerance of bore diameter deviation  $d_s$ , applicable to classes 4 and 2, is the same as the tolerance of mean bore diameter deviation  $d_{mp}$ . This applies to the diameter series 0 or 2 for class 4, and all the diameter series for class 2.
- ② Applicable to individual bearing rings manufactured for duplex bearings.

Table 13.15 Outer rings

Nominal outside diameter $D$  mm over incl.	Single plane mean outside diameter deviation $D_{mp}$						Single radial plane outside diameter deviation $V_{DP}$						Mean single plane outside diameter deviation $V_{Dmp}$			Outer ring radial runout $K_{ea}$		
	Class 5		Class 4 ③		Class 2 ③		Diameter series 9			Diameter series 0,2			Class 5 Class 4 Class 2			Class 5 Class 4 Class 2		
	high	low	high	low	high	low	Class 5	Class 4	Class 2	Class 5	Class 4	Class 2	Class 5	Class 4	Class 2	Class 5	Class 4	Class 2
18 30	0	-6	0	-5	0	-4	6	5	4	5	4	4	3	2.5	2	6	4	2.5
30 50	0	-7	0	-6	0	-4	7	6	4	5	5	4	4	3	2	7	5	2.5
50 80	0	-9	0	-7	0	-4	9	7	4	7	5	4	5	3.5	2	8	5	4
80 120	0	-10	0	-8	0	-5	10	8	5	8	6	5	5	4	2.5	10	6	5

- ③ The tolerance of outside diameter deviation  $D_s$ , applicable to classes 4 and 2, is the same as the tolerance of mean outside diameter deviation  $D_{mp}$ . This applies to the diameter series 0 or 2 for class 4, and all the diameter series for class 2.

Accuracy of AXN and ARN type

Table 13.16 Inner ring and outer ring

Nominal bearing bore dia. $d$ or nominal bearing outside dia. $D$  mm Over Incl.	Deviation of mean bore diameter in a single plane $d_{mp}$				Thrust inner ring bore dia. deviation $d_s$		Deviation of mean outside diameter in a single plane $D_{mp}$				Bearing height deviation $T_s$		Outer ring width deviation $C_s$		Radial inner ring radial runout $K_{ia}$	
	Class 5		Class 4		High	Low	Class 5		Class 4		High	Low	High	Low	Class 5	
	High	Low	High	Low			High	Low	High	Low					Max.	
18 30	0	-6	0	-5	+61	+40	-	-	-	-	-	-	-	-	4	3
30 50	0	-8	0	-6	+75	+50	-	-	-	-	-	-	-	-	5	4
50 80	0	-9	0	-7	+90	+60	0	-9	0	-7	0	-370	0	-130	5	4
80 120	-	-	-	-	-	-	0	-10	0	-8	-	-	-	-	-	-
120 150	-	-	-	-	-	-	0	-11	0	-9	-	-	-	-	-	-

- ① Applicable only to dimension  $d$ .
- ② Applicable only to dimension  $D$ .



Unit:  $\mu\text{m}$

Face runout with bore $S_d$			Axial runout $S_{ia}$			Width variation $B_s$				Width variation $VB_s$				
Class 5	Class 4	Class 2	Class 5	Class 4	Class 2	Single bearing		Duplex bearing <sup>①</sup>		Class 5	Class 4	Class 2		
						Class 5	Class 4	Class 5	Class 4					
max			max			high	low	high	low	max				
7	3	1.5	7	3	1.5	0	- 40	0	- 40	0	-250	5	2.5	1.5
7	3	1.5	7	3	1.5	0	- 80	0	- 80	0	-250	5	2.5	1.5
8	4	1.5	8	4	2.5	0	-120	0	-120	0	-250	5	2.5	1.5
8	4	1.5	8	4	2.5	0	-120	0	-120	0	-250	5	3	1.5

Unit:  $\mu\text{m}$

Outside surface inclination $S_D$			Axial runout $S_{ea}$			Width variation $C_s$		Width variation $VC_s$		
Class 5	Class 4	Class 2	Class 5	Class 4	Class 2	All classes		Class 5	Class 4	Class 2
						Class 5	Class 4			
max			max					max		
8	4	1.5	8	5	2.5	Identical to $B_s$ relative to $d$ of the same bearing		5	2.5	1.5
8	4	1.5	8	5	2.5			5	2.5	1.5
8	4	1.5	10	5	4			6	3	1.5
9	5	2.5	11	6	5			8	4	2.5

Unit:  $\mu\text{m}$

Outer ring <sup>②</sup> radial runout $K_{ea}$		Perpendicularity of outer ring outside surface with respect to the face $S_D$		Thrust inner ring and outer ring thickness variation <sup>①</sup> $S_{ia}, S_{ea}$	
Class 5	Class 4	Class 5	Class 4	Class 5	Class 4
—	—	—	—	3	2
—	—	—	—	3	2
8	5	8	4	4	3
10	6	9	5	4	3
11	7	10	5	5	4

⑦ Basic preload and axial rigidity

Basic preloads for each type of ball screw support bearings are shown in the dimension tables. The preloads can be altered depending on the required rigidity. Contact NTN in such a case. In the AXN and ARN types, rigidity is normally enhanced by tightening the thrust bearing rings to supply preload. Preloads and torques are shown in the dimensions tables to help control basic preload. A bearing that allows preset preload by tightening the bearing raceways to adjust the clearance A between the thrust bearing ring and radial bearing ring (Fig. 13.19) is also available. Ask NTN for details.

Axial rigidity of the 2A-BST type DB duplex arrangement and the AXN type at the basic preload are shown in Figs. 13.20 and 13.21.

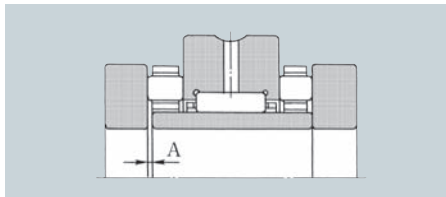


Fig. 13.19

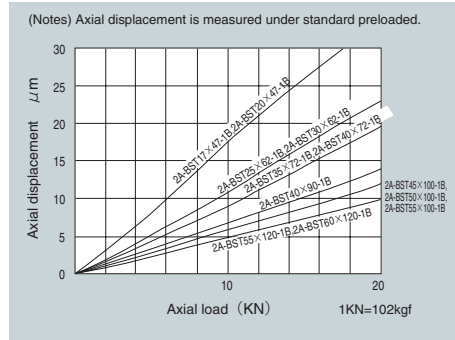


Fig. 13.20 BST type rigidity chart

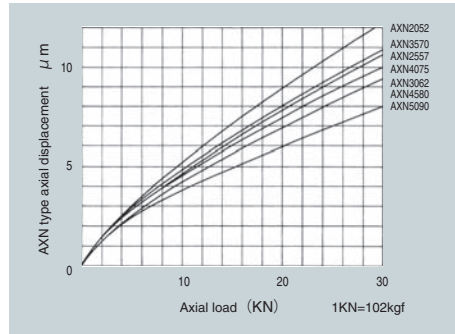


Fig. 13.21 AXN type rigidity chart

### ⑧ Shaft and housing fits

Recommended fit and tolerances of shaft and housing shoulder squareness are shown in **Tables 13.17** and **13.18**.

**Table 13.17 Shaft and housing fits**

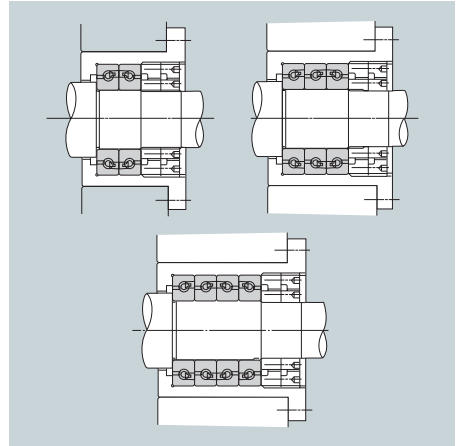
Type code	Fit	
	Shaft outside diameter	Housing
BST HT	h5	H6
BSTU	h5	H6
AXN ARN	j5	J6

**Table 13.18 Tolerance of shoulder squareness** Unit:  $\mu\text{m}$

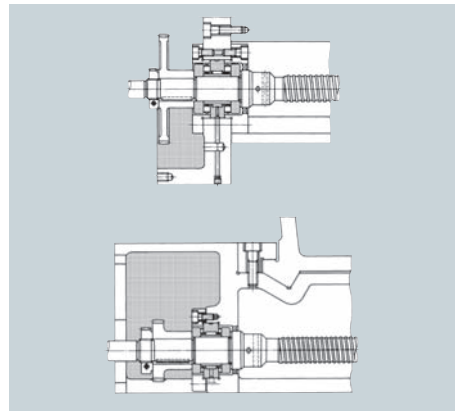
Diameter classification mm		Type code			
over	incl.	BST	BSTU	HT	AXN, ARN
—	30	4	4	4	4
30	80	4	4	4	5
80	120	5	5	—	6
120	180	—	—	—	7

### ⑨ Applications

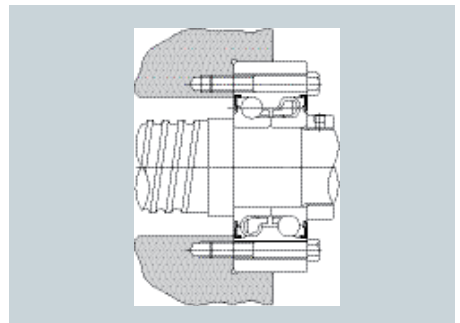
The BST type is mainly installed on ball screws of machine tool feed systems, and two to four row arrangements are used in many cases. This type is popular because greased sealed angular contact ball bearings are easy to handle. The back-to-back duplex arrangement is commonly used because it allows acquisition of the specified preload by tightening the inner ring. The face-to-face duplex arrangement may be used if more precise alignment is required. It is not commonly used for machine tools. Examples of bearing arrangement are shown in **Figs. 13.22** and **13.24**.



**Fig. 13.22**



**Fig. 13.23**



**Fig. 13.24**

10 Starting torque of 2A-BST type

Reference starting torque values for 2A-BST bearings are shown in **Tables 13.19** and **13.20**.

**Table 13.19** Open type BST and 2A-BST

	Starting torque (reference) N · mm [kgf · cm]			
	DF type DB type	DFT type DBT type	DTFT type DTBT type	DFTT type DBTT type
BST17X47-1B 2A-BST17X47-1B	175 {1.8}	245 {2.5}	355 {3.6}	275 {2.8}
BST20X47-1B 2A-BST20X47-1B	175 {1.8}	245 {2.5}	355 {3.6}	275 {2.8}
BST25X62-1B 2A-BST25X62-1B	305 {3.1}	420 {4.3}	615 {6.3}	470 {4.8}
BST30X62-1B 2A-BST30X62-1B	305 {3.1}	420 {4.3}	615 {6.3}	470 {4.8}
BST35X72-1B 2A-BST35X72-1B	380 {3.9}	510 {5.2}	755 {7.7}	590 {6.0}
BST40X72-1B 2A-BST40X72-1B	380 {3.9}	510 {5.2}	755 {7.7}	590 {6.0}
BST40X90-1B 2A-BST40X90-1B	960 {9.8}	1305 {13.3}	1930 {19.7}	1500 {15.3}
BST45X75-1B 2A-BST45X75-1B	430 {4.4}	580 {5.9}	860 {8.8}	665 {6.8}
BST45X100-1B 2A-BST45X100-1B	1165 {11.9}	1580 {16.1}	2340 {23.9}	1815 {18.5}
BST50X100-1B 2A-BST50X100-1B	1165 {11.9}	1580 {16.1}	2340 {23.9}	1815 {18.5}
BST55X100-1B 2A-BST55X100-1B	1165 {11.9}	1580 {16.1}	2340 {23.9}	1815 {18.5}

**Table 13.20** Light-contact sealed type BST LXL/L588 and 2A-BST LXL/L588

	Starting torque (reference) N · mm [kgf · cm]			
	DF type DB type	DFT type DBT type	DTFT type DTBT type	DFTT type DBTT type
BST17X47-1BLXL 2A-BST17X47-1BLXL	215 {2.2}	295 {3.0}	420 {4.3}	355 {3.4}
BST20X47-1BLXL 2A-BST20X47-1BLXL	215 {2.2}	295 {3.0}	420 {4.3}	355 {3.4}
BST25X62-1BLXL 2A-BST25X62-1BLXL	365 {3.7}	510 {5.2}	745 {7.6}	570 {5.8}
BST30X62-1BLXL 2A-BST30X62-1BLXL	365 {3.7}	510 {5.2}	745 {7.6}	570 {5.8}
BST35X72-1BLXL 2A-BST35X72-1BLXL	460 {4.7}	610 {6.2}	900 {9.2}	705 {7.28}
BST40X72-1BLXL 2A-BST40X72-1BLXL	460 {4.7}	610 {6.2}	900 {9.2}	705 {7.2}
BST40X90-1BLXL 2A-BST40X90-1BLXL	1155 {11.8}	1570 {16.0}	2315 {23.6}	1805 {18.4}
BST45X75-1BLXL 2A-BST45X75-1BLXL	520 {5.3}	695 {7.1}	1040 {10.6}	805 {8.2}
BST45X100-1BLXL 2A-BST45X100-1BLXL	1400 {14.3}	1890 {19.3}	2815 {28.7}	2175 {22.2}
BST50X100-1BLXL 2A-BST50X100-1BLXL	1400 {14.3}	1890 {19.3}	2815 {28.7}	2175 {22.2}
BST55X100-1BLXL 2A-BST55X100-1BLXL	1400 {14.3}	1890 {19.3}	2815 {28.7}	2175 {22.2}

## ① Recommended lubrication specifications

BST and HT ball screw support angular contact ball bearings are generally lubricated with grease. (BST LXL bearings with light-contact seals are packed with grease.) AXN and ARN bearings are generally lubricated with circulated oil.

### ■ Grease lubrication

#### ● Recommended type of grease

Lithium-mineral oil base general purpose grease of which base oil viscosity is high (for example, Alvania Grease S2, Shell).

#### ● Recommended grease fill

25% of the capacity shown in the dimensions tables

#### ● Recommended grease filling method

Refer to "6. Handling of Bearings, ① Rinsing of bearings and grease filling" in the Technical Data section.

### ■ Oil lubrication

#### ● Recommended type of oil

Hydraulic oils or other industrial oils used for lubrication of sliding surfaces with viscosity grade ISO VG 68 or higher are recommended.

#### ● Oil quantity

Recommended oil quantity depends on the lubricating method. As a general guideline, the oil flow rate should be 5 to 10 cm<sup>3</sup>/min.

## 12 Dimension tables

### ULTAGE Angular contact thrust ball bearings for ball screws BST series

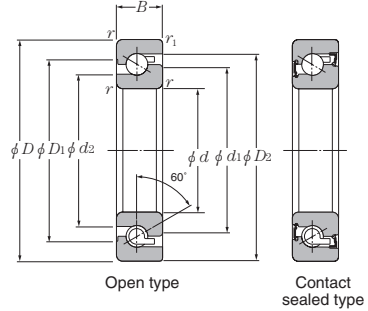
Contact angle 60°  $d$  17~60mm

Dynamic equivalent axial load  $P_a = XF_r + YF_a$

Number of rows in bearing arrangement	2		3			4				
	1	2	1	2	3	1	2	3	4	
$F_a / F_r \leq 2.17$	X	1.90	—	1.43	2.32	—	1.17	1.90	2.52	—
	Y	0.55	—	0.76	0.35	—	0.88	0.55	0.26	—
$F_a / F_r > 2.17$	X	0.92	0.92	0.92	0.92	0.92	0.92	0.92	0.92	0.92
	Y	1	1	1	1	1	1	1	1	1

Static equivalent axial load

$$P_{0a} = F_a + 3.98F_r$$

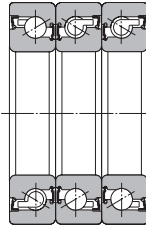


Part number	Boundary dimensions					Basic dynamic rated load $C_a$			Basic static rated load $C_{0a}$		
	mm					1	kN kgf 2	3	1	kN kgf 2	3
	$d$	$D$	$B$	$r_s$ min <sup>①</sup>	$r_{1s}$ min <sup>①</sup>						
BST17X47-1B BST17X47-1BLXL	17	47	15	1	0.6	24.3 2 470	39.5 4 000	52.5 5 350	37.5 3 850	75.0 7 650	113 11 500
BST20X47-1B BST20X47-1BLXL	20	47	15	1	0.6	24.3 2 470	39.5 4 000	52.5 5 350	37.5 3 850	75.0 7 650	113 11 500
BST25X62-1B BST25X62-1BLXL	25	62	15	1	0.6	29.2 2 980	47.5 4 850	63.0 6 450	59.0 6 050	118 12 100	177 18 100
BST30X62-1B BST30X62-1BLXL	30	62	15	1	0.6	29.2 2 980	47.5 4 850	63.0 6 450	59.0 6 050	118 12 100	177 18 100
BST35X72-1B BST35X72-1BLXL	35	72	15	1	0.6	31.0 3 150	50.5 5 150	67.0 6 850	70.0 7 150	140 14 300	210 21 400
BST40X72-1B BST40X72-1BLXL	40	72	15	1	0.6	31.0 3 150	50.5 5 150	67.0 6 850	70.0 7 150	140 14 300	210 21 400
BST40X90-1B BST40X90-1BLXL	40	90	20	1	0.6	58.5 6 000	95.0 9 700	126 12 900	130 13 300	261 26 600	390 40 000
BST45X75-1B BST45X75-1BLXL	45	75	15	1	0.6	32.0 3 300	52.0 5 350	69.5 7 100	77.5 7 900	155 15 800	232 23 700
BST45X100-1B BST45X100-1BLXL	45	100	20	1	0.6	62.0 6 350	101 10 300	134 13 700	153 15 600	305 31 000	459 47 000
BST50X100-1B BST50X100-1BLXL	50	100	20	1	0.6	62.0 6 350	101 10 300	134 13 700	153 15 600	305 31 000	459 47 000
BST55X100-1B BST55X100-1BLXL	55	100	20	1	0.6	62.0 6 350	101 10 300	134 13 700	153 15 600	305 31 000	459 47 000
BST55X120-1B BST55X120-1BLXL	55	120	20	1	0.6	66.5 6 750	108 11 000	143 14 600	183 18 700	365 37 500	550 56 000
BST60X120-1B BST60X120-1BLXL	60	120	20	1	0.6	66.5 6 750	108 11 000	143 14 600	183 18 700	365 37 500	550 56 000

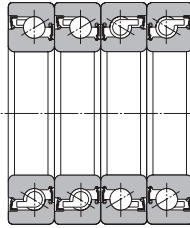
① Minimum allowable value for chamfer dimension  $r$  or  $r_1$ .



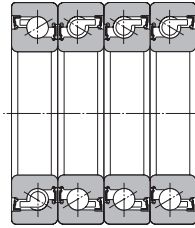
When one row bears axial load (DB)



When two rows bear axial load (DBT)



When two rows bear axial load (DTBT)



When three rows bear axial load (DBTT)

Dimensions				Space capacity cm <sup>3</sup> Single-row (approx.)	Static axial load capacity		
mm					1	2	3
<i>d</i> <sub>1</sub>	<i>d</i> <sub>2</sub>	<i>D</i> <sub>1</sub>	<i>D</i> <sub>2</sub>		kN	kgf	
29.9	27.1	37.1	40.8	3.3	25.7	51.5	77.0
	25.7		41.2		2 620	5 250	7 850
29.9	27.1	37.1	40.8	3.3	25.7	51.5	77.0
	25.7		41.2		2 620	5 250	7 850
44.4	41.6	51.6	55.3	4.6	40.0	80.5	121
	40.2		55.7		4 100	8 200	12 300
44.4	41.6	51.6	55.3	4.6	40.0	80.5	121
	40.2		55.7		4 100	8 200	12 300
52.4	49.6	59.6	63.2	5.4	47.5	95.0	143
	48.2		63.7		4 850	9 700	14 600
52.4	49.6	59.6	63.2	5.4	47.5	95.0	143
	48.2		63.7		4 850	9 700	14 600
64.8	60.7	75.2	80.4	12	88.5	177	265
	59.1		81.6		9 000	18 000	27 000
58.4	55.6	65.6	69.2	6.0	52.5	177	158
	54.2		69.7		5 350	10 700	16 100
75.8	71.7	86.2	91.4	13	104	208	315
	70.1		92.6		10 600	21 200	32 000
75.8	71.7	86.2	91.4	13	104	208	315
	70.1		92.6		10 600	21 200	32 000
75.8	71.7	86.2	91.4	13	104	208	315
	70.1		92.6		10 600	21 200	32 000
90.8	86.7	106.4	106.4	16	124	249	375
	85.1	107.6	107.6		12 700	25 400	38 000
90.8	86.7	106.4	106.4	16	124	249	375
	85.1	107.6	107.6		12 700	25 400	38 000

## ULTAGE Angular contact thrust ball bearings for ball screws 2A-BST series

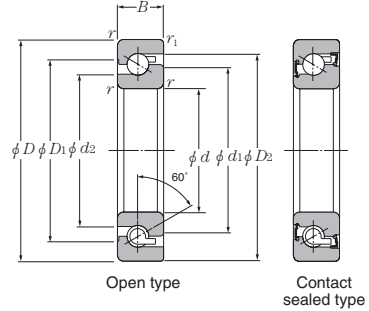
Contact angle 60°  $d$  17~60mm

Dynamic equivalent axial load  $P_a = XF_r + YF_a$

Number of rows in bearing arrangement	2		3			4				
	1	2	1	2	3	1	2	3	4	
Number of rows subjected to axial load	1	2	1	2	3	1	2	3	4	
$F_a / F_r \leq 2.17$	X	1.90	—	1.43	2.32	—	1.17	1.90	2.52	—
	Y	0.55	—	0.76	0.35	—	0.88	0.55	0.26	—
$F_a / F_r > 2.17$	X	0.92	0.92	0.92	0.92	0.92	0.92	0.92	0.92	0.92
	Y	1	1	1	1	1	1	1	1	1

Static equivalent axial load

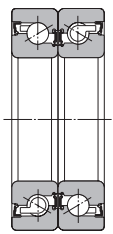
$$P_{0a} = F_a + 3.98F_r$$



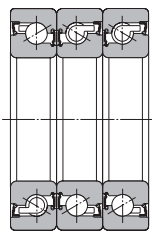
Part number	Boundary dimensions					Basic dynamic rated load $C_a$			Basic static rated load $C_{0a}$		
	mm					kN			kN		
	$d$	$D$	$B$	$r_s$ min <sup>①</sup>	$r_{1s}$ min <sup>①</sup>	1	kgf 2	3	1	kgf 2	3
2A-BST17X47-1B 2A-BST17X47-1BLXL	17	47	15	1	0.6	24.3 2 470	39.5 4 000	52.5 5 350	37.5 3 850	75.0 7 650	113 11 500
2A-BST20X47-1B 2A-BST20X47-1BLXL	20	47	15	1	0.6	24.3 2 470	39.5 4 000	52.5 5 350	37.5 3 850	75.0 7 650	113 11 500
2A-BST25X62-1B 2A-BST25X62-1BLXL	25	62	15	1	0.6	29.2 2 980	47.5 4 850	63.0 6 450	59.0 6 050	118 12 100	177 18 100
2A-BST30X62-1B 2A-BST30X62-1BLXL	30	62	15	1	0.6	29.2 2 980	47.5 4 850	63.0 6 450	59.0 6 050	118 12 100	177 18 100
2A-BST35X72-1B 2A-BST35X72-1BLXL	35	72	15	1	0.6	31.0 3 150	50.5 5 150	67.0 6 850	70.0 7 150	140 14 300	210 21 400
2A-BST40X72-1B 2A-BST40X72-1BLXL	40	72	15	1	0.6	31.0 3 150	50.5 5 150	67.0 6 850	70.0 7 150	140 14 300	210 21 400
2A-BST40X90-1B 2A-BST40X90-1BLXL	40	90	20	1	0.6	58.5 6 000	95.0 9 700	126 12 900	130 13 300	261 26 600	390 40 000
2A-BST45X75-1B 2A-BST45X75-1BLXL	45	75	15	1	0.6	32.0 3 300	52.0 5 350	69.5 7 100	77.5 7 900	155 15 800	232 23 700
2A-BST45X100-1B 2A-BST45X100-1BLXL	45	100	20	1	0.6	62.0 6 350	101 10 300	134 13 700	153 15 600	305 31 000	459 47 000
2A-BST50X100-1B 2A-BST50X100-1BLXL	50	100	20	1	0.6	62.0 6 350	101 10 300	134 13 700	153 15 600	305 31 000	459 47 000
2A-BST55X100-1B 2A-BST55X100-1BLXL	55	100	20	1	0.6	62.0 6 350	101 10 300	134 13 700	153 15 600	305 31 000	459 47 000
2A-BST55X120-1B 2A-BST55X120-1BLXL	55	120	20	1	0.6	66.5 6 750	108 11 000	143 14 600	183 18 700	365 37 500	550 56 000
2A-BST60X120-1B 2A-BST60X120-1BLXL	60	120	20	1	0.6	66.5 6 750	108 11 000	143 14 600	183 18 700	365 37 500	550 56 000

① Minimum allowable value for chamfer dimension  $r$  or  $r_1$ .

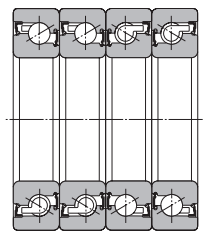




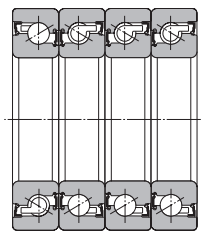
When one row bears axial load (DB)



When two rows bear axial load (DBT)



When two rows bear axial load (DTBT)



When three rows bear axial load (DBTT)

Dimensions				Space capacity cm <sup>3</sup> Single-row (approx.)	Static axial load capacity		
mm					1	2	3
<i>d</i> <sub>1</sub>	<i>d</i> <sub>2</sub>	<i>D</i> <sub>1</sub>	<i>D</i> <sub>2</sub>		kN	kgf	
29.9	27.1	37.1	40.8	4.3	25.7	51.5	77.0
	25.7		41.2		2 620	5 250	7 850
29.9	27.1	37.1	40.8	6.3	25.7	51.5	77.0
	25.7		41.2		2 620	5 250	7 850
44.4	41.6	51.6	55.3	6.1	40.0	80.5	121
	40.2		55.7		4 100	8 200	12 300
44.4	41.6	51.6	55.3	6.1	40.0	80.5	121
	40.2		55.7		4 100	8 200	12 300
52.4	49.6	59.6	63.2	7.1	47.5	95.0	143
	48.2		63.7		4 850	9 700	14 600
52.4	49.6	59.6	63.2	7.1	47.5	95.0	143
	48.2		63.7		4 850	9 700	14 600
64.8	60.7	75.2	80.4	17	88.5	177	265
	59.1		81.6		9 000	18 000	27 000
58.4	55.6	65.6	69.2	7.9	52.5	177	158
	54.2		69.7		5 350	10 700	16 100
75.8	71.7	86.2	91.4	20	104	208	315
	70.1		92.6		10 600	21 200	32 000
75.8	71.7	86.2	91.4	20	104	208	315
	70.1		92.6		10 600	21 200	32 000
90.8	86.7	106.4	106.4	17	124	249	375
	85.1	101.2	107.6		12 700	25 400	38 000
90.8	86.7	106.4	106.4	17	124	249	375
	85.1	101.2	107.6		12 700	25 400	38 000

## ULTAGE Angular contact thrust ball bearings for ball screws BST Type, 2A-BST Type

Contact angle 60°  $d$  17~60mm

Part number	Basic preload : -1B											
	Double-row (DF/DB types)				Triple-row (DFT/DBT types)				Four-row (DTFT/DTBT types)			
	Preload		Axial spring constant		Preload		Axial spring constant		Preload		Axial spring constant	
	N	kgf	N/ $\mu$ m	kgf/ $\mu$ m	N	kgf	N/ $\mu$ m	kgf/ $\mu$ m	N	kgf	N/ $\mu$ m	kgf/ $\mu$ m
BST17X47 2A-BST17X47	2 060	210	635	65	2 840	290	930	95	4 100	420	1 270	130
BST20X47 2A-BST20X47	2 060	210	635	65	2 840	290	930	95	4 100	420	1 270	130
BST25X62 2A-BST25X62	3 250	330	980	100	4 400	450	1 370	140	6 450	660	1 960	200
BST30X62 2A-BST30X62	3 250	330	980	100	4 400	450	1 370	140	6 450	660	1 960	200
BST35X72 2A-BST35X72	3 800	390	1 130	115	5 200	530	1 620	165	7 650	780	2 260	230
BST40X72 2A-BST40X72	3 800	390	1 130	115	5 200	530	1 620	165	7 650	780	2 260	230
BST40X90 2A-BST40X90	7 050	720	1 470	150	9 600	980	2 110	215	14 100	1 440	2 940	300
BST45X75 2A-BST45X75	4 200	430	1 230	125	5 700	580	1 770	180	8 450	860	2 500	255
BST45X100 2A-BST45X100	8 250	840	1 720	175	11 200	1 140	2 450	250	16 500	1 680	3 450	350
BST50X100 2A-BST50X100	8 250	840	1 720	175	11 200	1 140	2 450	250	16 500	1 680	3 450	350
BST55X100 2A-BST55X100	8 250	840	1 720	175	11 200	1 140	2 450	250	16 500	1 680	3 450	350
BST55X120 2A-BST55X120	9 900	1 010	2 010	205	13 400	1 370	2 890	295	19 800	2 020	4 050	415
BST60X120 2A-BST60X120	9 900	1 010	2 010	205	13 400	1 370	2 890	295	19 800	2 020	4 050	415

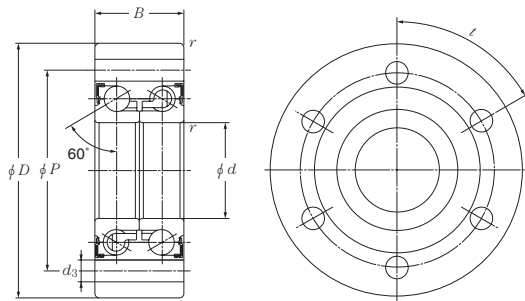
NOTE) Preload values are those obtained from matched bearings.

Spring constants mean axial spring constants on bearings subjected to the preloads listed in the table.

Part number	Light preload : -11B											
	Double-row (DF/DB types)				Triple-row (DFT/DBT types)				Four-row (DTFT/DTBT types)			
	Preload		Axial spring constant		Preload		Axial spring constant		Preload		Axial spring constant	
	N	kgf	N/ $\mu$ m	kgf/ $\mu$ m	N	kgf	N/ $\mu$ m	kgf/ $\mu$ m	N	kgf	N/ $\mu$ m	kgf/ $\mu$ m
BST17X47 2A-BST17X47	1 000	102	490	50	1 370	140	735	75	1 960	200	980	100
BST20X47 2A-BST20X47	1 000	102	490	50	1 370	140	735	75	1 960	200	980	100
BST25X62 2A-BST25X62	1 470	150	735	75	1 960	200	1 080	110	2 940	300	1 470	150
BST30X62 2A-BST30X62	1 560	159	735	75	2 160	220	1 080	110	3 150	320	1 470	150
BST35X72 2A-BST35X72	1 760	180	885	90	2 350	240	1 270	130	3 550	360	1 770	180
BST40X72 2A-BST40X72	1 860	190	885	90	2 550	260	1 270	130	3 700	380	1 770	180
BST40X90 2A-BST40X90	2 370	240	980	100	3 230	330	1 470	150	4 700	480	2 060	210
BST45X75 2A-BST45X75	2 000	200	980	100	2 650	270	1 370	140	3 900	400	1 960	200
BST45X100 2A-BST45X100	2 880	290	1 180	120	3 800	390	1 770	180	5 700	580	2 450	250
BST50X100 2A-BST50X100	3 010	310	1 180	120	4 100	420	1 770	180	6 100	620	2 450	250
BST55X100 2A-BST55X100	3 010	310	1 180	120	4 100	420	1 770	180	6 100	620	2 450	250
BST55X120 2A-BST55X120	3 520	360	1 370	140	4 800	490	2 060	210	7 050	720	2 840	290
BST60X120 2A-BST60X120	3 520	360	1 370	140	4 800	490	2 060	210	7 050	720	2 840	290

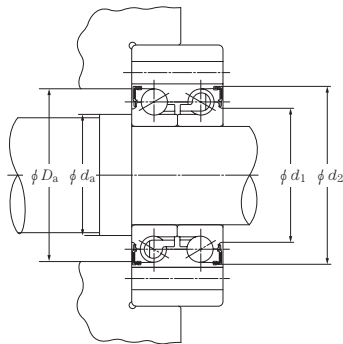
## ULTAGE Ball screw support double row thrust angular contact ball bearing unit BSTU LLX type

$d$  20~100mm



Part number	Boundary dimensions						Basic load ratings				Allowable axial load		Limiting speed min <sup>-1</sup> lubrication	Reference dimensions	
	mm						dynamic	static	dynamic	static	(static)	d <sub>1</sub>		d <sub>2</sub>	
	d	D	B	r <sub>min</sub> <sup>①</sup>	P	d <sub>3</sub>	kN	kgf	kN	kgf					
BSTU2068LLX	20	68	28	0.6	53	6.8	31.0	3 200	48.0	4 900	24.0	2 450	6 000	30.1	43
BSTU2575LLX	25	75	28	0.6	58	6.8	34.0	3 450	58.0	5 950	28.5	2 910	5 000	36.1	49
BSTU3080LLX	30	80	28	0.6	63	6.8	36.5	3 700	68.5	6 950	33.0	3 350	4 500	41.1	54
BSTU30100LLX	30	100	38	0.6	80	8.8	73.5	7 500	121	12 400	61.5	6 250	4 000	47.1	65
BSTU40100LLX	40	100	34	0.6	80	8.8	52.0	5 300	106	10 800	50.5	5 150	3 500	54.1	68.9
BSTU40115LLX	40	115	46	0.6	94	8.8	89.0	9 050	167	17 000	82.5	8 400	3 200	61.1	80.2
BSTU90190LLX	90	190	55	0.6	165	11	158	16 100	415	42 000	195	19 900	1 700	116.1	138.7
BSTU100200LLX	100	200	55	0.6	175	11	160	16 300	435	44 500	205	20 900	1 500	128.1	150.7

① Minimum allowable value for chamfer dimension r.



### Dynamic equivalent radial load

$$P_a = X F_r + Y F_a$$

$e$	$F_a / F_r \leq e$		$F_a / F_r > e$	
	$X$	$Y$	$X$	$Y$
2.17	1.90	0.55	0.92	1

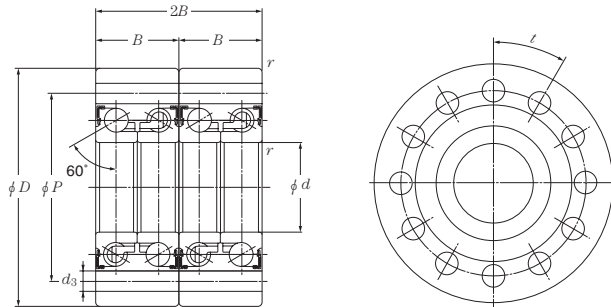
### Static equivalent radial load

$$P_{0a} = F_a + 3.98 F_r$$

Abutment and fillet dimensions mm		Outer ring mounting bolt		Preload		Mass	Bearing friction torque	Axial bearing rigidity	Rigidity against moment	Mass moment of inertia	Part number
$D_a$ max	$d_a$ min	Screws	Quantity $\times$ $l$	N	kgf	kg (approx.)	Nm (approx.)	N/ $\mu$ m	Nm/mrad	kg $\cdot$ cm <sup>2</sup>	
42	26	M6	4 $\times$ 90°	2 100	215	0.60	0.2	675	150	0.25	BSTU2068LLX
48	32	M6	4 $\times$ 90°	2 400	245	0.72	0.3	790	230	0.45	BSTU2575LLX
53	37	M6	6 $\times$ 60°	2 700	275	0.78	0.3	900	315	0.68	BSTU3080LLX
64	39	M8	8 $\times$ 45°	4 800	490	1.71	0.8	1 040	500	1.99	BSTU30100LLX
68	49	M8	4 $\times$ 90°	3 200	325	1.46	0.4	1 050	610	2.16	BSTU40100LLX
80	52	M8	12 $\times$ 30°	5 800	590	2.57	1.0	1 260	960	5.52	BSTU40115LLX
137	104	M10	8 $\times$ 45°	8 200	835	7.95	1.5	2 010	4 700	60.0	BSTU90910LLX
150	116	M10	8 $\times$ 45°	8 800	900	8.47	1.7	2 130	5 800	83.8	BSTU100200LLX

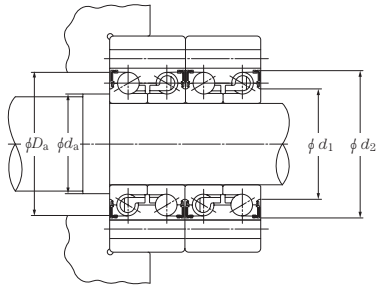
# ULTAGE Ball screw support double row thrust angular contact ball bearing unit BSTU LLX D2 type

$d$  20~40mm



Part number	Boundary dimensions						Basic load ratings				Allowable axial load		Limiting speed min <sup>-1</sup> lubrication	Reference dimensions	
	mm						dynamic kN	static kgf	dynamic kN	static kgf	(static)			d <sub>1</sub>	d <sub>2</sub>
	d	D	B	r <sub>min</sub> <sup>①</sup>	P	d <sub>3</sub>	C <sub>a</sub>	C <sub>a</sub>	C <sub>oa</sub>	C <sub>oa</sub>					
BSTU2068LLXD2	20	68	56	0.6	53	6.8	50.5	5 150	96.0	9 800	48.0	4 900	6 000	30.1	43
BSTU2575LLXD2	25	75	56	0.6	58	6.8	55.0	5 600	116	11 900	57.0	5 820	5 000	36.1	49
BSTU3080LLXD2	30	80	56	0.6	63	6.8	59.0	6 000	137	13 900	65.0	6 700	4 500	41.1	54
BSTU40100LLXD2	40	100	68	0.6	80	8.8	84.0	8 600	212	21 600	101	10 300	3 500	54.1	68.9
BSTU40115LLXD2	40	115	92	0.6	94	8.8	144	14 700	335	34 000	165	16 800	3 200	61.1	80.2

① Minimum allowable value for chamfer dimension r.



### Dynamic equivalent radial load

$$P_a = X F_r + Y F_a$$

e	$F_a / F_r \leq e$		$F_a / F_r > e$	
	X	Y	X	Y
2.17	—	—	0.92	1

### Static equivalent radial load

$$P_{0a} = F_a + 3.98 F_r$$

Abutment and fillet dimensions mm		Outer ring mounting bolt		Preload		Mass	Bearing friction torque	Axial bearing rigidity	Rigidity against moment	Mass moment of inertia	Part number
$D_a$ max	$d_a$ min	Screws	Quantity × l	N	kgf	kg (approx.)	Nm (approx.)	N/μm	Nm/mrad	kg · cm <sup>2</sup>	
42	26	M6	8×45*	4 200	430	1.20	0.5	1 350	340	0.50	BSTU2068LLXD2
48	32	M6	8×45*	4 800	490	1.44	0.5	1 580	510	0.90	BSTU2575LLXD2
53	37	M6	12×30*	5 400	550	1.56	0.6	1 800	690	1.36	BSTU3080LLXD2
68	49	M8	8×45*	6 350	650	2.92	0.8	2 100	1 310	4.32	BSTU40100LLXD2
80	52	M8	12×30*	11 600	1 180	5.14	2.0	2 520	2 150	11.0	BSTU40115LLXD2

## Duplex angular contact ball bearings (HT series)

Contact angle 30°  $d$  6~40mm

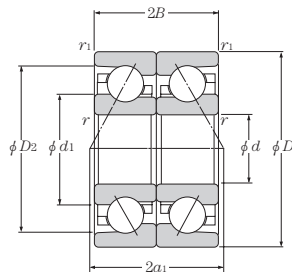
### Dynamic equivalent axial load

$$P_a = XF_r + YF_a$$

Number of rows in bearing arrangement		2		3			4				
Number of rows subjected to axial load		1	2	1	2	3	1	2	3	4	
$F_a$	$F_r \leq 0.80$	X	0.81	—	0.61	0.99	—	0.50	0.81	1.07	—
		Y	0.63	—	0.88	0.40	—	1.02	0.63	0.30	—
$F_a$	$F_r > 0.80$	X	0.51	0.51	0.51	0.51	0.51	0.51	0.51	0.51	0.51
		Y	1	1	1	1	1	1	1	1	1

### Static equivalent axial load

$$P_{0a} = 1.52F_r + F_a$$



Back-to-back (DB)

Example diagram 1

Part number		Boundary dimensions					Basic load ratings				Dimensions				Load center		Diagram
Back-to-back (DB)	Face-to-face (DF)	mm					dynamic kN	static kN	dynamic kgf	static kgf	mm				cm <sup>3</sup>		
		$d$	$D$	$2B$	$r_{S \min}$ <sup>①</sup>	$r_{1S \min}$ <sup>①</sup>	$C_a$	$C_{0a}$	$C_a$	$C_{0a}$	$d_1$	$d_2$	$D_1$	$D_2$	$a_1$	$a_2$	
79M6ADB	79M6ADF	6	15	10	0.2	0.1	2.05	2.09	209	213	9.9	8.4	11.1	12.9	11.1	1.1	1
70M6DB	70M6DF	6	17	12	0.3	0.15	2.67	2.41	273	246	9.8	—	13.2	14.8	12.7	0.7	2
79M8ADB	79M8ADF	8	19	12	0.3	0.15	2.93	3.25	298	335	12.6	10.9	14.4	16.4	13.9	1.9	1
70M8DB	70M8DF	8	22	14	0.3	0.15	4.40	4.40	450	445	12.8	—	17.2	19.1	15.8	1.8	2
7000HTDB	7000HTDF	10	26	16	0.3	0.15	6.10	6.30	620	640	15.5	—	20.3	22.7	18.4	2.4	2
7001HTDB	7001HTDF	12	28	16	0.3	0.15	6.65	7.45	680	760	18.1	—	22.9	25.4	20.0	4.0	2
7002HTDB	7002HTDF	15	32	18	0.3	0.15	7.60	9.50	775	970	21.1	—	25.9	28.4	22.7	4.7	2
7203HTDB	7203HTDF	17	40	24	0.6	0.3	13.8	16.4	1 400	1 670	25.0	—	32.0	36.2	28.8	4.8	2
7004HTDB	7004HTDF	20	42	24	0.6	0.3	12.8	17.0	1 300	1 730	28.4	—	34.7	38.1	30.3	6.3	2
7204HTDB	7204HTDF	20	47	28	1.0	0.6	17.9	23.1	1 830	2 360	30.5	—	38.6	42.7	34.1	6.1	2
7205HTDB	7205HTDF	25	52	30	1.0	0.6	20.2	28.8	2 060	2 940	35.0	—	43.0	47.2	37.7	7.7	2
7206HTDB	7206HTDF	30	62	32	1.0	0.6	28.1	41.5	2 860	4 200	41.7	—	51.4	56.3	43.1	11.1	2
7207HTDB	7207HTDF	35	72	34	1.1	0.6	37.0	56.0	3 800	5 750	47.9	—	59.2	64.9	48.2	14.2	2
7208HTDB	7208HTDF	40	80	36	1.1	0.6	44.0	71.0	4 500	7 200	54.0	—	66.0	72.2	52.9	16.9	2

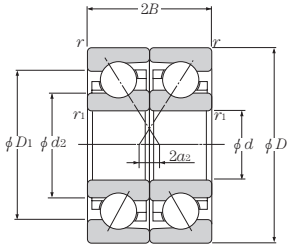
① Minimum allowable value for chamfer dimension  $r$  or  $r_1$ .

② The number of rows means the number of bearings that bear the axial load.

③ Preload values are those obtained from matched bearings.

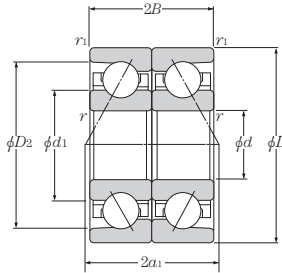
④ Spring constants mean axial spring constants on bearings subjected to the preloads listed in the table.





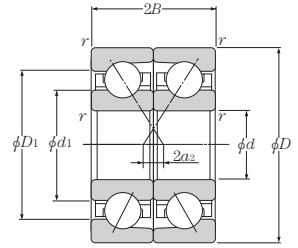
Face-to-face (DF)

Example diagram 1



Back-to-back (DB)

Example diagram 2



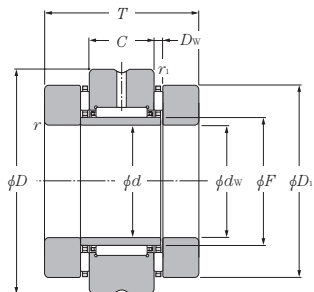
Face-to-face (DF)

Example diagram 2

Static axial load <sup>②</sup> capacity		Medium preload (GM)										Starting torque		Heavy preload (GH)									
		Preload <sup>③</sup>		Axial spring constant <sup>④</sup>				Preload <sup>③</sup>		Axial spring constant <sup>④</sup>				Starting torque									
		N	kgf	DB DF	DBT DFT	N/μm	kgf/μm	DB DF	DBT DFT	N	kgf			DB DF	DBT DFT	N/μm	kgf/μm	N·mm	(approx.)				
Single row	Double row	DB DF	DBT DFT	DB DF	DBT DFT	DB DF	DBT DFT	DB DF	DBT DFT	DB DF	DBT DFT	DB DF	DBT DFT	DB DF	DBT DFT	DB DF	DBT DFT						
1.83	187	3.66	374	20	2	27	3	37	3.8	55	5.6	0.4	0.6	39	4	53	5.5	48	4.9	67	6.8	1.0	1.1
1.01	103	2.02	206	29	3	39	4	37	3.8	53	5.4	0.8	1.0	49	5	67	7	45	4.6	65	6.6	1.5	2.2
2.14	219	4.28	438	29	3	39	4	48	4.9	68	6.9	0.7	0.9	59	6	80	8	62	6.3	88	9.0	1.7	2.3
1.53	156	3.06	312	49	5	67	7	52	5.3	75	7.6	1.6	2.2	98	10	133	14	67	6.9	97	9.9	4.0	5.7
3.10	314	6.20	628	147	15	200	20	82	8.4	116	11.8	7.4	9.7	196	20	266	27	92	9.4	131	13.3	11.0	14.7
3.25	331	6.50	662	147	15	200	20	88	9.0	125	12.7	7.2	9.5	196	20	266	27	99	10.1	140	14.3	10.8	14.4
4.00	407	8.00	814	147	15	200	20	100	10.2	141	14.4	6.9	9.1	294	30	400	41	131	13.4	187	19.1	18.1	24.7
5.85	595	11.7	1190	294	30	400	41	126	12.9	180	18.4	20.5	27.9	390	40	530	54	141	14.4	201	20.5	30.5	40.8
7.55	770	15.1	1540	294	30	400	41	139	14.2	199	20.3	19.3	26.2	490	50	665	68	170	17.3	242	24.7	39.3	53.1
9.50	970	19.0	1940	490	50	665	68	168	17.2	240	24.5	41.5	56.1	785	80	1070	109	203	20.7	289	29.5	79.7	108
11.5	1170	23.0	2340	490	50	665	68	188	19.2	269	27.4	39.7	53.7	785	80	1070	109	226	23.1	323	32.9	76.4	104
16.3	1660	32.6	3320	490	50	665	68	197	20.0	281	28.6	41.3	55.8	785	80	1070	109	235	24.0	336	34.2	79.4	108
21.9	2230	43.8	4470	885	90	1200	122	255	26.0	363	37.1	96.4	130	1470	150	2000	204	311	31.7	443	45.2	196	265
27.1	2770	54.2	5540	885	90	1200	122	272	27.8	389	39.6	95.8	129	1470	150	2000	204	331	33.8	473	48.2	195	264

## Needle roller bearings with double-direction thrust needle roller bearings (AXN series)

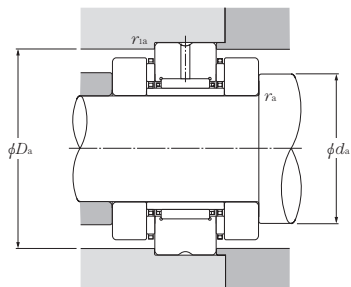
$d$  20~50mm



Part number	Boundary dimensions										Basic load ratings						
	$d$	$d_w$	mm							$r_3$ min <sup>①</sup>	$r_{15}$ min <sup>①</sup>	dynamic radial		dynamic radial		dynamic axial	
			$D$	$D_1$	$T$	$C$	$F$	$D_w$	$C_r$			$C_{or}$	$C_r$	$C_{or}$	$C_a$	$C_{oa}$	
AXN2052	20	20	$^{+0.061}_{+0.040}$	52	42	40	16	25	2	0.6	0.6	15.1	22.4	1 540	2 280	14.6	58.0
AXN2557	25	25	$^{+0.061}_{+0.040}$	57	47	44	20	30	2	0.6	0.6	22.1	34.0	2 260	3 500	16.3	69.5
AXN3062	30	30	$^{+0.061}_{+0.040}$	62	52	44	20	35	2	0.6	0.6	24.8	41.5	2 520	4 250	17.8	81.5
AXN3570	35	35	$^{+0.075}_{+0.050}$	70	60	48	20	40	3	1	0.6	26.4	47.0	2 700	4 800	27.4	110
AXN4075	40	40	$^{+0.075}_{+0.050}$	75	65	48	20	45	3	1	0.6	28.0	52.5	2 860	5 400	29.8	128
AXN4580	45	45	$^{+0.075}_{+0.050}$	80	70	54	25	50	3	1	0.6	38.5	74.5	3 950	7 550	31.5	143
AXN5090	50	50	$^{+0.075}_{+0.050}$	90	78	54	25	55	3	1	0.6	41.0	82.0	4 150	8 400	38.0	186

① Minimum allowable value for corner radius dimension  $r$  or  $r_1$ .

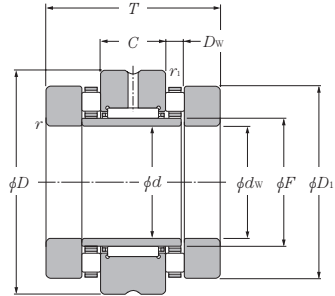
② Starting torque value relative to the standard preload.



Basic load ratings		Limiting speeds		Radial clearance		Abutment and fillet dimensions				Preload	Starting torque <sup>①</sup>	Mass	Part number
dynamic	static	min <sup>-1</sup>		$\mu\text{m}$		mm							
$C_a$	$C_{0a}$	grease lubrication	oil lubrication	min	max	$d_a$ min	$D_a$ max	$r_{2a}$ max	$r_{1a}$ max		(approx.)	(approx.)	
1 490	5 900	1 800	7 000	10	30	39	46	0.6	0.6	1 300	330	0.400	AXN2052
1 660	7 100	1 500	6 000	10	30	44	51	0.6	0.6	1 450	400	0.520	AXN2557
1 820	8 300	1 400	5 500	10	40	50	56	0.6	0.6	1 600	550	0.590	AXN3062
2 790	11 300	1 200	4 700	10	40	56	64	1	0.6	2 450	900	0.800	AXN3570
3 050	13 100	1 100	4 300	10	40	62	69	1	0.6	2 650	1 050	0.890	AXN4075
3 250	14 500	1 000	3 900	10	40	67	74	1	0.6	2 800	1 200	1.00	AXN4580
3 850	19 000	900	3 500	15	50	75	83	1	0.6	3 400	1 600	1.42	AXN5090

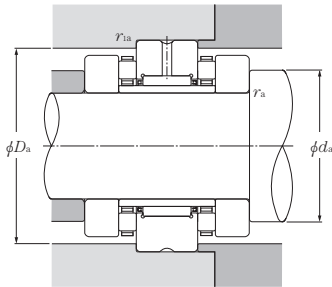
## Needle roller bearings with double-direction thrust cylindrical roller bearings (ARN series)

$d$  20~70mm



Part number	Boundary dimensions											Basic load ratings					
	mm											dynamic radial kN		dynamic radial kgf		dynamic axial kN	
	$d$	$d_w$	$D$	$D_1$	$T$	$C$	$F$	$D_w$	$r_3$ min <sup>①</sup>	$r_1$ min <sup>①</sup>	$C_r$	$C_{or}$	$C_r$	$C_{or}$	$C_a$	$C_{oa}$	
ARN2052T2	20	20	$^{+0.061}_{+0.040}$	52	42	46	16	25	5	0.6	0.6	15.1	22.4	1 540	2 280	27.3	68.0
ARN2062	20	20	$^{+0.061}_{+0.040}$	62	52	60	20	30	7.5	1	0.6	22.1	34.0	2 260	3 500	53.5	129
ARN2557T2	25	25	$^{+0.061}_{+0.040}$	57	47	50	20	30	5	0.6	0.6	22.1	34.0	2 260	3 500	27.8	72.5
ARN2572	25	25	$^{+0.061}_{+0.040}$	72	62	60	20	35	7.5	1	0.6	24.8	41.5	2 520	4 250	54.5	139
ARN3062T2	30	30	$^{+0.061}_{+0.040}$	62	52	50	20	35	5	0.6	0.6	24.8	41.5	2 520	4 250	31.0	87.0
ARN3080	30	30	$^{+0.061}_{+0.040}$	80	68	66	20	40	9	1	0.6	26.4	47.0	2 700	4 800	74.5	190
ARN3570T2	35	35	$^{+0.075}_{+0.050}$	70	60	54	20	40	6	1	0.6	26.4	47.0	2 700	4 800	43.0	121
ARN3585	35	35	$^{+0.075}_{+0.050}$	85	73	66	20	45	9	1	0.6	28.0	52.5	2 860	5 400	82.0	222
ARN4075T2	40	40	$^{+0.075}_{+0.050}$	75	65	54	20	45	6	1	0.6	28.0	52.5	2 860	5 400	45.5	135
ARN4090	40	40	$^{+0.075}_{+0.050}$	90	78	75	25	50	9	1	0.6	38.5	74.5	3 950	7 550	85.0	238
ARN4580T2	45	45	$^{+0.075}_{+0.050}$	80	70	60	25	50	6	1	0.6	38.5	74.5	3 950	7 550	48.0	150
ARN45105	45	45	$^{+0.075}_{+0.050}$	105	90	82	25	55	11	1	0.6	41.0	82.0	4 150	8 400	121	340
ARN5090	50	50	$^{+0.075}_{+0.050}$	90	78	60	25	55	6	1	0.6	41.0	82.0	4 150	8 400	62.5	215
ARN50110	50	50	$^{+0.075}_{+0.050}$	110	95	82	25	60	11	1.1	0.6	41.0	85.0	4 200	8 700	125	365
ARN55115	55	55	$^{+0.080}_{+0.060}$	115	100	82	25	65	11	1.1	0.6	44.5	98.0	4 550	10 000	130	385
ARN60120	60	60	$^{+0.080}_{+0.060}$	120	105	82	25	70	11	1.1	0.6	45.0	91.5	4 600	9 350	134	410
ARN65125	65	65	$^{+0.080}_{+0.060}$	125	110	82	25	75	11	1.1	0.6	55.0	104	5 600	10 600	138	435
ARN70130	70	70	$^{+0.080}_{+0.060}$	130	115	82	25	80	11	1.1	0.6	57.0	119	5 800	12 200	142	460

① Minimum allowable value for corner radius dimension  $r$  or  $r_1$ .  
 ② Starting torque value relative to the standard preload.



Basic load ratings		Limiting speeds		Radial clearance		Abutment and fillet dimensions				Preload	Starting torque <sup>①</sup>	Mass	Part number
dynamic	static	grease lubrication	oil lubrication	min	max	mm							
$C_a$	$C_{0a}$					min <sup>1</sup>	$\mu m$	$d_a$ min	$D_a$ max	$r_{as}$ max	$r_{1as}$ max		
2 780	6 900	1 800	7 000	10	30	39	46	0.6	0.6	2 500	430	0.440	ARN2052T2
5 450	13 100	1 500	6 000	10	30	48	56	1	0.6	4 950	1 150	0.910	ARN2062
2 840	7 400	1 500	6 000	10	30	44	51	0.6	0.6	2 600	500	0.560	ARN2557T2
5 550	14 200	1 200	4 900	10	40	56	66	1	0.6	5 050	1 400	1.22	ARN2572
3 150	8 900	1 400	5 500	10	40	49	56	0.6	0.6	2 900	650	0.630	ARN3062T2
7 600	19 400	1 100	4 400	10	40	63	73	1	0.6	6 900	2 100	1.54	ARN3080
4 350	12 400	1 200	4 800	10	40	56	64	1	0.6	3 950	1 050	0.850	ARN3570T2
8 350	22 600	1 000	4 100	10	40	68	77	1	0.6	7 600	2 500	1.67	ARN3585
4 650	13 800	1 100	4 400	10	40	61	69	1	0.6	4 200	1 250	0.930	ARN4075T2
8 650	24 200	950	3 800	10	40	73	87	1	0.6	7 850	2 850	2.15	ARN4090
4 900	15 300	1 000	4 000	10	40	66	74	1	0.6	4 450	1 550	1.16	ARN4580T2
12 300	34 500	850	3 300	15	50	83	96	1	0.6	11 200	4 350	3.16	ARN45105
6 350	21 900	900	3 600	15	50	75	83	1	0.6	5 800	2 050	1.48	ARN5090
12 800	37 000	800	3 100	15	50	88	101	1	0.6	11 600	4 900	3.38	ARN50110
13 200	39 500	750	2 900	15	50	93	106	1	0.6	12 000	5 500	3.61	ARN55115
13 700	42 000	700	2 700	15	50	98	111	1	0.6	12 400	6 000	3.81	ARN60120
14 100	44 500	650	2 600	15	50	103	116	1	0.6	12 800	6 500	4.00	ARN65125
14 500	47 000	650	2 500	15	50	106	121	1	0.6	13 200	7 000	4.25	ARN70130

## 14. NTN Products

### Cam followers for pallet changer

Cam followers are often used on work piece transfer systems (such as pallet changers) of machine tools (such as machining centers) to handle the large loads generated by these systems.

NTN offers various types of cam followers that include a ready-to-install cam follower optimized for pallet changers.

#### ① Structure and features

- The outer ring wall thickness is maximized for resistance to heavy load or impact load.
- NTN cam followers for pallet changers feature a compact design and can be easily mounted by tightening a setscrew.
- The outer diameter, outer ring width, and stud diameter are identical to the dimensions of NTN's standard cam followers (KR type).
- Because cam followers for pallet changers are actuated less frequently, they do not need to be lubricated. The oil hole has been deleted.
- Cost is reduced by removing the grease hole and the thread from the stud.

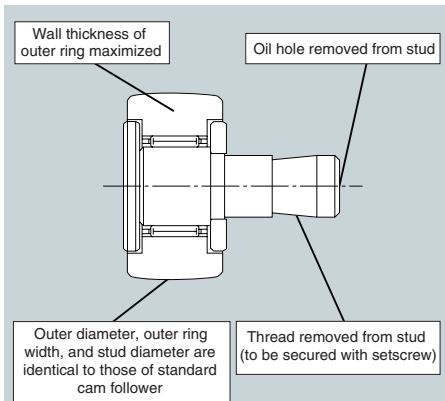
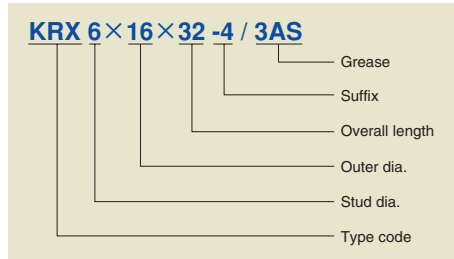


Fig. 14-1 Schematic of NTN pallet changer cam follower

#### ② Cam follower numbering

The part number for cam followers for pallet changers is same as that of NTN special cam followers.



#### ③ Accuracy

The accuracy of NTN cam followers for pallet changer is same as that of NTN standard cam followers (JIS class 0).

#### ④ Fit

The NTN pallet changer cam follower has a special stud that is readily secured with a setscrew. As illustrated below, a setscrew locks the pallet changer cam follower in the axial and circumferential directions.

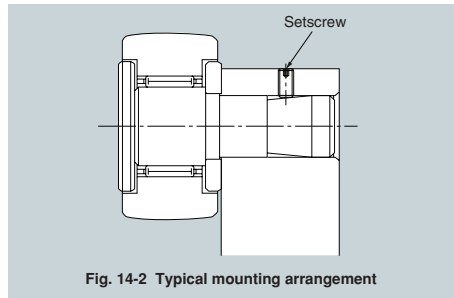


Fig. 14-2 Typical mounting arrangement

## ⑤ Radial internal clearance

The radial clearance of NTN cam followers for pallet changers is same as that of NTN standard cam followers (**Table 14-1**).

**Table 14-1. Inner ring**

Nominal inscribed circle diameter $F_w$		Clearance CN (normal clearance)	
over	incl.	min	max
3	6	3	17
6	10	5	20
10	18	5	25
18	30	10	30
30	50	10	40

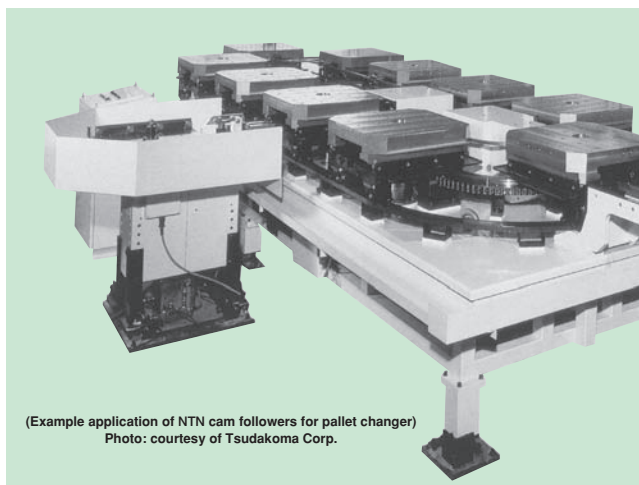
## ⑥ Lubrication

NTN cam followers for pallet changers are prefilled with lithium based grease and can be used in a temperature range of -25 to +100°C.

Under the assumption that the user does not perform relubrication with grease, the standard NTN pallet changer cam follower does not have an oil hole for relubrication. (If necessary, the cam follower can be provided with an oil hole or a hole for mounting a grease nipple.)

Upon request, NTN can also provide cam followers with a synthetic rubber seal.

**Lubrication between the outside surface of bearing and track is also necessary. Failure to properly lubricate the outside surface of the cam follower could lead to premature wear of the bearing.**

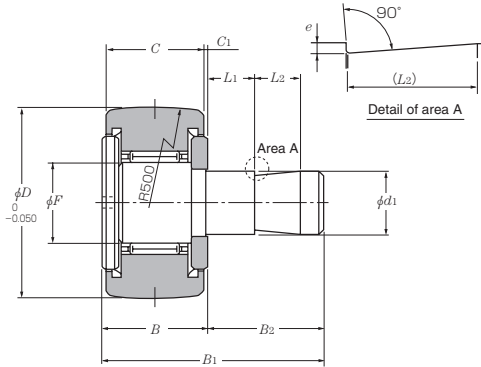


(Example application of NTN cam followers for pallet changer)  
Photo: courtesy of Tsudakoma Corp.

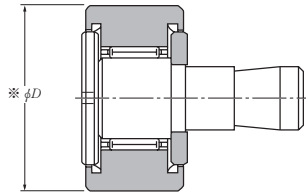
⑦ Cam followers for pallet changers dimension table

Sealed KRX type  $d$  6~20mm

Spherical outer ring type



Cylindrical outer ring type

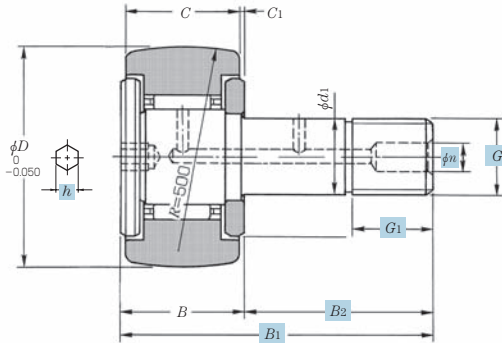


Cam follower number		Dimensions mm												
Spherical outer ring	Cylindrical outer ring	$d_1$	Tolerance	$D$	Tolerance* (cylindrical outer ring)	$F$	$B_1$	$B$	$B_2$	$C$	$C_1$	$L_1$	$L_2$	$e$
KRX6×16×32-4/3AS	KRX6×16×32-2/3AS	6	$\begin{matrix} 0 \\ -0.012 \end{matrix}$	16	$\begin{matrix} 0 \\ -0.008 \end{matrix}$	8	32	12	20	11	0.6	5	10	0.3
KRX8×19×32-9/3AS	KRX8×19×32-7/3AS	8	$\begin{matrix} 0 \\ -0.015 \end{matrix}$	19	$\begin{matrix} 0 \\ -0.009 \end{matrix}$	10	32	12	20	11	0.6	5	10	0.5
KRX10×22×33-3/3AS	KRX10×22×33-1/3AS	10	$\begin{matrix} 0 \\ -0.015 \end{matrix}$	22	$\begin{matrix} 0 \\ -0.009 \end{matrix}$	12	33	13	20	12	0.6	5	10	0.5
KRX10×26×33-4/3AS	KRX10×26×33-2/3AS	10	$\begin{matrix} 0 \\ -0.015 \end{matrix}$	26	$\begin{matrix} 0 \\ -0.009 \end{matrix}$	12	33	13	20	12	0.6	5	10	0.5
KRX12×30×35-3/3AS	KRX12×30×35/3AS	12	$\begin{matrix} 0 \\ -0.018 \end{matrix}$	30	$\begin{matrix} 0 \\ -0.009 \end{matrix}$	15	35	15	20	14	0.6	5	10	1.0
KRX12×32×35-3/3AS	KRX12×32×35-1/3AS	12	$\begin{matrix} 0 \\ -0.018 \end{matrix}$	32	$\begin{matrix} 0 \\ -0.011 \end{matrix}$	15	35	15	20	14	0.6	5	10	1.0
KRX16×35×44.5-1/3AS	KRX16×35×44.5-3/3AS	16	$\begin{matrix} 0 \\ -0.018 \end{matrix}$	35	$\begin{matrix} 0 \\ -0.011 \end{matrix}$	18	44.5	19.5	25	18	0.8	10	10	1.0
KRX18×40×46.5-6/3AS	KRX18×40×46.5-4/3AS	18	$\begin{matrix} 0 \\ -0.018 \end{matrix}$	40	$\begin{matrix} 0 \\ -0.011 \end{matrix}$	22	46.5	21.5	25	20	0.8	10	10	1.0
KRX20×47×50.5-13/AS	KRX20×47×50.5-3/3AS	20	$\begin{matrix} 0 \\ -0.021 \end{matrix}$	47	$\begin{matrix} 0 \\ -0.011 \end{matrix}$	25	50.5	25.5	25	24	0.8	10	10	1.0
KRX20×52×50.5-3/3AS	KRX20×52×50.5-1/3AS	20	$\begin{matrix} 0 \\ -0.021 \end{matrix}$	52	$\begin{matrix} 0 \\ -0.013 \end{matrix}$	25	50.5	25.5	25	24	0.8	10	10	1.0

\*The cam followers in the table above have seals. However, upon request, NTN will offer a cam followers without seals.



(Reference) Standard cam follower KR...H type (w/ hex socket)



The dimensions of standard cam followers (marked with   in the diagram above) are different from those of NTN pallet changer cam followers. Please see the reference dimensions in the table below.

Basic load ratings		Track load capacity		(Reference dimensions) mm					
dynamic	static	spherical outer ring	cylindrical outer ring	$B_1$	$B_2$	G	$G_1$	n	h
$C_r$	$C_{or}$								
4 050 415	4 200 430	1 080 110	3 400 350	28	16	M6×1	8	—	3
4 750 480	5 400 555	1 380 141	4 050 415	32	20	M8×1.25	10	—	4
5 300 540	6 650 680	1 690 172	5 150 525	36	23	M10×1.25	12	4	4
5 300 540	6 650 680	2 120 216	6 100 620	36	23	M10×1.25	12	4	4
7 850 800	9 650 985	2 620 267	7 700 785	40	25	M12×1.5	13	6	6
7 850 800	9 650 985	2 860 291	8 200 835	40	25	M12×1.5	13	6	6
12 200 1 240	17 900 1 830	3 200 325	11 900 1 220	52	32.5	M16×1.5	17	6	6
14 000 1 430	22 800 2 330	3 850 390	14 500 1 480	58	36.5	M18×1.5	19	6	6
20 700 2 110	33 500 3 450	4 700 480	21 000 2 150	66	40.5	M20×1.5	21	8	8
20 700 2 110	33 500 3 450	5 550 565	23 300 2 370	66	40.5	M20×1.5	21	8	8



Table 1: Boundary dimensions of radial bearings (Tapered roller bearings not included)-2

Single row radial ball bearings		62 72		1,22 1,32		63 73		623 633		64 74															
Double row radial ball bearings		32 42		42 52		43 53		23 33																	
Cylindrical roller bearings		NN31		N2		N22 N32		N3		N23 N33															
Needle roller bearings										N4															
Spherical roller bearings		231 241		222 232		213		223																	
Nominal bearing diameter $d$		Diameter series 1					Diameter series 2					Diameter series 3					Diameter series 4								
Number	Unit	Dimension series					Dimension series					Dimension series					Dimension series								
		01	11	21	31	41	01-1	82	02	12	22	32	42	82	02-1	83	03	13	23	33	43	00-03	04	24	
Nominal diameter of bearing $D$		Nominal width $B$					Nominal width $B$					Nominal width $B$					Nominal width $B$	Chamber diameter $y$ min							
Nominal diameter of bore $d$		Chamber diameter $y$ min					Chamber diameter $y$ min					Chamber diameter $y$ min					Nominal width $B$	Chamber diameter $y$ min							
1	—	—	—	—	—	—	—	—	—	—	—	—	—	—	—	—	—	—	—	—	—	—	—	—	—
3	3	—	—	—	—	—	—	—	—	—	—	—	—	—	—	—	—	—	—	—	—	—	—	—	—
4	4	—	—	—	—	—	—	—	—	—	—	—	—	—	—	—	—	—	—	—	—	—	—	—	—
5	5	—	—	—	—	—	—	—	—	—	—	—	—	—	—	—	—	—	—	—	—	—	—	—	—
6	6	—	—	—	—	—	—	—	—	—	—	—	—	—	—	—	—	—	—	—	—	—	—	—	—
7	7	—	—	—	—	—	—	—	—	—	—	—	—	—	—	—	—	—	—	—	—	—	—	—	—
8	8	—	—	—	—	—	—	—	—	—	—	—	—	—	—	—	—	—	—	—	—	—	—	—	—
9	9	—	—	—	—	—	—	—	—	—	—	—	—	—	—	—	—	—	—	—	—	—	—	—	—
00	10	—	—	—	—	—	—	—	—	—	—	—	—	—	—	—	—	—	—	—	—	—	—	—	—
01	12	—	—	—	—	—	—	—	—	—	—	—	—	—	—	—	—	—	—	—	—	—	—	—	—
02	15	—	—	—	—	—	—	—	—	—	—	—	—	—	—	—	—	—	—	—	—	—	—	—	—
03	17	—	—	—	—	—	—	—	—	—	—	—	—	—	—	—	—	—	—	—	—	—	—	—	—
04	20	—	—	—	—	—	—	—	—	—	—	—	—	—	—	—	—	—	—	—	—	—	—	—	—
05	25	—	—	—	—	—	—	—	—	—	—	—	—	—	—	—	—	—	—	—	—	—	—	—	—
06	30	—	—	—	—	—	—	—	—	—	—	—	—	—	—	—	—	—	—	—	—	—	—	—	—
07	35	—	—	—	—	—	—	—	—	—	—	—	—	—	—	—	—	—	—	—	—	—	—	—	—
08	40	—	—	—	—	—	—	—	—	—	—	—	—	—	—	—	—	—	—	—	—	—	—	—	—
09	45	—	—	—	—	—	—	—	—	—	—	—	—	—	—	—	—	—	—	—	—	—	—	—	—
10	50	—	—	—	—	—	—	—	—	—	—	—	—	—	—	—	—	—	—	—	—	—	—	—	—
11	55	—	—	—	—	—	—	—	—	—	—	—	—	—	—	—	—	—	—	—	—	—	—	—	—
12	60	—	—	—	—	—	—	—	—	—	—	—	—	—	—	—	—	—	—	—	—	—	—	—	—
13	65	—	—	—	—	—	—	—	—	—	—	—	—	—	—	—	—	—	—	—	—	—	—	—	—
14	70	—	—	—	—	—	—	—	—	—	—	—	—	—	—	—	—	—	—	—	—	—	—	—	—
15	75	—	—	—	—	—	—	—	—	—	—	—	—	—	—	—	—	—	—	—	—	—	—	—	—
16	80	—	—	—	—	—	—	—	—	—	—	—	—	—	—	—	—	—	—	—	—	—	—	—	—
17	85	—	—	—	—	—	—	—	—	—	—	—	—	—	—	—	—	—	—	—	—	—	—	—	—
18	90	—	—	—	—	—	—	—	—	—	—	—	—	—	—	—	—	—	—	—	—	—	—	—	—
19	95	—	—	—	—	—	—	—	—	—	—	—	—	—	—	—	—	—	—	—	—	—	—	—	—
20	100	165	21	30	39	52	65	1.1	1.2	180	25	34	—	—	—	—	—	—	—	—	—	—	—	—	—
21	105	175	22	33	42	56	69	1.1	1.2	190	27	36	—	—	—	—	—	—	—	—	—	—	—	—	—
22	110	180	22	33	42	56	69	1.1	1.2	200	28	38	—	—	—	—	—	—	—	—	—	—	—	—	—
24	120	200	25	38	48	62	80	1.5	2.1	215	—	—	—	—	—	—	—	—	—	—	—	—	—	—	—
26	130	210	25	38	48	62	80	1.5	2.1	230	—	—	—	—	—	—	—	—	—	—	—	—	—	—	—
28	140	225	27	40	50	68	85	1.5	2.1	250	—	—	—	—	—	—	—	—	—	—	—	—	—	—	—
30	150	250	31	46	60	80	100	2	2.1	270	—	—	—	—	—	—	—	—	—	—	—	—	—	—	—
32	160	270	34	51	66	86	109	2	2.1	290	—	—	—	—	—	—	—	—	—	—	—	—	—	—	—
34	170	280	34	51	66	86	109	2	2.1	310	—	—	—	—	—	—	—	—	—	—	—	—	—	—	—
36	180	300	37	56	72	96	118	2	3	320	—	—	—	—	—	—	—	—	—	—	—	—	—	—	—
38	190	320	42	60	78	104	128	3	3	340	—	—	—	—	—	—	—	—	—	—	—	—	—	—	—
40	200	340	44	65	82	112	140	3	3	360	—	—	—	—	—	—	—	—	—	—	—	—	—	—	—
44	220	370	48	69	88	120	150	3	4	400	—	—	—	—	—	—	—	—	—	—	—	—	—	—	—
48	240	400	50	74	95	128	160	4	4	440	—	—	—	—	—	—	—	—	—	—	—	—	—	—	—
52	260	440	57	82	106	144	180	4	4	480	—	—	—	—	—	—	—	—	—	—	—	—	—	—	—
56	280	460	57	82	106	144	180	4	5	500	—	—	—	—	—	—	—	—	—	—	—	—	—	—	—
60	300	500	63	90	118	160	200	5	5	540	—	—	—	—	—	—	—	—	—	—	—	—	—	—	—
64	320	540	71	100	128	176	218	5	5	580	—	—	—	—	—	—	—	—	—	—	—	—	—	—	—
68	340	580	78	106	140	190	243	5	5	620	—	—	—	—	—	—	—	—	—	—	—	—	—	—	—
72	360	600	78	106	140	192	243	5	5	650	—	—	—	—	—	—	—	—	—	—	—	—	—	—	—
76	380	620	78	106	140	194	243	5	5	680	—	—	—	—	—	—	—	—	—	—	—	—	—	—	—
80	400	650	80	112	145	200	250	6	6	720	—	—	—	—	—	—	—	—	—	—	—	—	—	—	—
84	420	700	88	122	165	224	280	6	6	760	—	—	—	—	—	—	—	—	—	—	—	—	—	—	—
88	440	720	88	122	165	226	280	6	6	790	—	—	—	—	—	—	—	—	—	—	—	—	—	—	—
92	460	760	90	125	172	240	300	6	7	830	—	—	—	—	—	—	—	—	—	—	—	—	—	—	—
96	480	790	90	125	172	240	300	6	7	850	—	—	—	—	—	—	—	—	—	—	—	—	—	—	—
100	500	830	106	145	190	264	325	7.5	7.5	920	—	—	—	—	—	—	—	—	—	—	—	—	—	—	—
110	530	870	109	150	195	272	335	7.5	7.5	980	—	—	—	—	—	—	—	—	—	—	—	—	—	—	—
120	560	920	115	160	206	280	355	7.5	7.5	1030	—	—	—	—	—	—	—	—	—	—	—	—	—	—	—
130	600	980	122	170	218	300	375	7.5	7.5	1090	—	—	—	—	—	—	—	—	—	—	—	—	—	—	—
136	630	1030	128	175	230	315	400	7.5	7.5	1150	—	—	—	—	—	—	—	—	—	—	—	—	—	—	—
140	670	1090	136	185	243	336	412	7.5	7.5	1220	—	—	—	—	—	—	—	—	—	—	—	—	—	—	—
150	710	1150	140	195	250	345	438	9.5	9.5	1280	—	—	—	—	—	—	—	—	—	—	—	—	—	—	—
160	750	1220	150	206	272	365	475	9.5	9.5	1360	—	—	—	—	—	—	—	—	—	—	—	—	—	—	—
180	800	1280	155	212	272	375	475	9.5	9.5	1420	—	—	—	—	—	—	—	—	—	—	—	—	—	—	—
185	850	1360	165	224	290	400	500	12	12	1500	—	—	—	—	—	—	—	—	—	—	—	—	—	—	—
190	900	1420	165	230	300	412	515	12	12	1580	—	—	—	—	—	—	—	—	—	—	—	—	—	—	—
195	950	1500	175	243	315	438	545	12	12	1660	—														

**Table 2: Comparison of SI, CGS and gravity units-1**

Unit system \ Quantity	Length <i>L</i>	Mass <i>M</i>	Time <i>T</i>	Acceleration	Force	Stress	Pressure	Energy
SI	m	kg	s	m/s <sup>2</sup>	N	Pa	Pa	J
CGS system	cm	g	s	Gal	dyn	dyn/cm <sup>2</sup>	dyn/cm <sup>2</sup>	erg
Gravitation system	m	kgf · s <sup>2</sup> /m	s	m/s <sup>2</sup>	kgf	kgf/m <sup>2</sup>	kgf/m <sup>2</sup>	kgf · m

**Table 3: SI-customary unit conversion table-1**

Quantity	Unit designation	Symbol	Conversion rate to SI	SI unit designation	Symbol
Angle	Degree	°	$\pi / 180$	Radian	rad
	Minute	'	$\pi / 10\ 800$		
	Second	" (sec)	$\pi / 648\ 000$		
Length	Meter	m	1	Meter	m
	Micron	$\mu$	$10^{-6}$		
	Angstrom	Å	$10^{-10}$		
Area	Square meter	m <sup>2</sup>	1	Square meter	m <sup>2</sup>
	Are	a	$10^2$		
	Hectare	ha	$10^4$		
Volume	Cubic meter	m <sup>3</sup>	1	Cubic meter	m <sup>3</sup>
	Liter	R.L	$10^{-3}$		
Mass	Kilogram	kg	1	Kilogram	kg
	Ton	t	$10^3$		
	Kilogram force / square second per meter	kgf · s <sup>2</sup> /m	9.806 65		
Time	Second	s	1	Second	s
	Minute	min	60		
	Hour	h	3 600		
	Day	d	86 400		
Speed	Meters per second	m/s	1	Meters per second	m/s
	Knot	kn	$1\ 852/3\ 600$		
Frequency and vibration	Cycle	s <sup>-1</sup> (pps)	1	Hertz	Hz
Revolutions (rotational speed)	Revolutions per minute (rpm)	rpm [min <sup>-1</sup> ]	1/60	Per second	s <sup>-1</sup>
Angular speed	Radians per second	rad/s	1	Radians per second	rad/s
Acceleration	Meters per square second	m/s <sup>2</sup>	1	Meters per second square	m/s <sup>2</sup>
	G	G	9.806 65		
Force	Kilogram force	kgf	9.806 65	Newton	N
	Ton force	tf	9 806.65		
	Dyne	dyn	$10^{-5}$		
Force moment	Kilogram force / meter	kgf · m	9.806 65	Newton meter	N · m
Inertia moment	Kilogram force / meter / square second	kgf · m · s <sup>-2</sup>	9.806 65	Kilogram / square meter	kg · m <sup>2</sup>
Stress	Kilogram force per square meter	kgf/m <sup>2</sup>	9.806 65	Pascal or newton per square meter	Pa or N/m <sup>2</sup>
Pressure	Kilogram force per square meter	kgf/m <sup>2</sup>	9.806 65	Pascal	Pa
	Meter water column	mH <sub>2</sub> O	9 806.65		
	Meter of mercury	mHg	$101\ 325/0.76$		
	Torr	Torr	$101\ 325/760$		
	Atmosphere	atm	$101\ 325$		
	Bar	bar	$10^5$		
Energy	Erg	erg	$10^{-7}$	Joule	J
	IT calorie	cal <sub>IT</sub>	4.186 8		
	Kilogram force / meter	kgf · m	9.806 65		
	Kilowatt hour	kW · h	$3.600 \times 10^6$		
	Metric horsepower per hour	PS · h	$2.647\ 79 \times 10^6$		
Power rate and power	Watt	W	1	Watt	W
	Metric horsepower	PS	735.5		
	Kilogram force / meter per second	kgf · m/s	9.806 65		

**Table 2: Comparison of SI, CGS and gravity units-2**

Unit system	Quantity	Power rate	Temperature	Viscosity	Dynamic viscosity	Magnetic flux	Flux density	Magnetic field strength
SI		W	K	Pa · s	m <sup>2</sup> /s	Wb	T	A/m
CGS system		erg/s	°C	P	St	Mx	Gs	Oe
Gravitation system		kgf · m/s	°C	kgf · s/m <sup>2</sup>	m <sup>2</sup> /s	—	—	—

**Table 3: SI-customary unit conversion table-2**

Quantity	Unit designation	Symbol	Conversion rate to SI	SI unit designation	Symbol
Viscosity	Poise	P	10 <sup>-1</sup>	Pascal second	Pa · s
	Centipoise	cP	10 <sup>-3</sup>		
	Kilogram force / square second per meter	kgf · s/m <sup>2</sup>	9.806 65		
Dynamic viscosity	Stokes	St	10 <sup>-4</sup>	Square meter per second	m <sup>2</sup> /s
	Centistokes	cSt	10 <sup>-6</sup>		
Temperature	Degree	°C	+273.15	Kelvin	K
Radioactive	Curie	Ci	3.7 × 10 <sup>10</sup>	Becquerel	Bq
Dosage	Roentgen	R	2.58 × 10 <sup>-4</sup>	Coulombs per kilogram	C/kg
Absorption dosage	Rad	rad	10 <sup>-2</sup>	Gray	Gy
Dosage equivalent	Rem	rem	10 <sup>-2</sup>	Sievert	Sv
Magnetic flux	Maxwell	Mx	10 <sup>-8</sup>	Weber	Wb
Flux density	Gamma	γ	10 <sup>-9</sup>	Tesla	T
	Gauss	Gs	10 <sup>-4</sup>		
Magnetic field strength	Oersted	Oe	10 <sup>3</sup> /4 π	Amperes per meter	A/m
Quantity of electricity	Coulomb	C	1	Coulomb	C
Potential difference	Volt	V	1	Volt	V
Electric resistance	Ohm	Ω	1	Ohm	Ω
Current	Ampere	A	1	Ampere	A

**Table 4: Tenth power multiples of SI unit**

Multiples of unit	Prefix		Multiples of unit	Prefix	
	Name	Symbol		Name	Symbol
10 <sup>18</sup>	Exa	E	10 <sup>1</sup>	Deci	d
10 <sup>15</sup>	Peta	P	10 <sup>-2</sup>	Centi	c
10 <sup>12</sup>	Tera	T	10 <sup>-3</sup>	Mili	m
10 <sup>9</sup>	Giga	G	10 <sup>-6</sup>	Micro	μ
10 <sup>6</sup>	Mega	M	10 <sup>-9</sup>	Nano	n
10 <sup>3</sup>	Kilo	k	10 <sup>-12</sup>	Pico	p
10 <sup>2</sup>	Hecto	h	10 <sup>-15</sup>	Femto	f
10	Deca	da	10 <sup>-18</sup>	Ato	a

Table 5: Dimensional tolerance for shafts

Diameter division mm		a13		c12		d6		e6		e13		f5		f6		g5		g6	
over	incl.	high	low	high	low	high	low	high	low	high	low	high	low	high	low	high	low	high	low
3	6	-270	-450	-70	-190	-30	-38	-20	-28	-20	-200	-10	-15	-10	-18	-4	-9	-4	-12
6	10	-280	-500	-80	-230	-40	-49	-25	-34	-25	-245	-13	-19	-13	-22	-5	-11	-5	-14
10	18	-290	-560	-95	-275	-50	-61	-32	-43	-32	-302	-16	-24	-16	-27	-6	-14	-6	-17
18	30	-300	-630	-110	-320	-65	-78	-40	-53	-40	-370	-20	-29	-20	-33	-7	-16	-7	-20
30	40	-310	-700	-120	-370	-80	-96	-50	-66	-50	-440	-25	-36	-25	-41	-9	-20	-9	-25
40	50	-320	-710	-130	-380	-100	-119	-60	-79	-60	-520	-30	-43	-30	-49	-10	-23	-10	-29
50	65	-340	-800	-140	-440	-120	-142	-72	-94	-72	-612	-36	-51	-36	-58	-12	-27	-12	-34
65	80	-360	-820	-150	-450	-140	-170	-85	-110	-85	-715	-43	-61	-43	-68	-14	-32	-14	-39
80	100	-380	-920	-170	-520	-170	-199	-100	-129	-100	-820	-50	-70	-50	-79	-15	-35	-15	-44
100	120	-410	-950	-180	-530	-190	-222	-110	-142	-110	-920	-56	-79	-56	-88	-17	-40	-17	-49
120	140	-460	-1 090	-200	-600	-210	-246	-125	-161	-125	-1 015	-62	-87	-62	-98	-18	-43	-18	-54
140	160	-520	-1 150	-210	-610	-230	-630	-135	-175	-135	-1 105	-68	-95	-68	-108	-20	-47	-20	-60
160	180	-580	-1 210	-230	-630	-260	-720	-145	-189	-145	-1 189	-76	-120	-76	-120	-22	-51	-22	-66
180	200	-660	-1 380	-240	-700	-290	-740	-160	-210	-160	-1 210	-80	-130	-80	-130	-24	-54	-24	-74
200	225	-740	-1 460	-260	-720	-320	-740	-170	-226	-170	-1 226	-86	-142	-86	-142	-26	-57	-26	-82
225	250	-820	-1 540	-280	-740	-350	-740	-195	-261	-195	-1 261	-98	-164	-98	-164	-28	-60	-28	-94
250	280	-920	-1 730	-300	-820	-390	-740	-220	-298	-220	-1 298	-110	-188	-110	-188	-30	-63	-30	-108
280	315	-1 050	-1 860	-330	-850	-440	-1 070	-230	-270	-230	-1 070	-110	-188	-110	-188	-30	-63	-30	-108
315	355	-1 200	-2 090	-360	-930	-480	-1 110	-230	-270	-230	-1 070	-110	-188	-110	-188	-30	-63	-30	-108
355	400	-1 350	-2 240	-400	-970	-560	-630	-260	-304	-260	-1 189	-145	-189	-145	-189	-22	-51	-22	-66
400	450	-1 500	-2 470	-440	-1 070	-630	-710	-290	-340	-290	-1 210	-160	-210	-160	-210	-24	-54	-24	-74
450	500	-1 650	-2 620	-480	-1 110	-710	-800	-320	-376	-320	-1 226	-170	-226	-170	-226	-26	-57	-26	-82
500	560	-	-	-	-	-260	-304	-145	-189	-	-	-	-	-76	-120	-	-	-22	-66
560	630	-	-	-	-	-290	-340	-160	-210	-	-	-	-	-80	-130	-	-	-24	-74
630	710	-	-	-	-	-320	-376	-170	-226	-	-	-	-	-86	-142	-	-	-26	-82
710	800	-	-	-	-	-350	-416	-195	-261	-	-	-	-	-98	-164	-	-	-28	-94
800	900	-	-	-	-	-390	-468	-220	-298	-	-	-	-	-110	-188	-	-	-30	-108
900	1 000	-	-	-	-	-	-	-	-	-	-	-	-	-	-	-	-	-	-
1 000	1 120	-	-	-	-	-	-	-	-	-	-	-	-	-	-	-	-	-	-
1 120	1 250	-	-	-	-	-	-	-	-	-	-	-	-	-	-	-	-	-	-
1 250	1 400	-	-	-	-	-	-	-	-	-	-	-	-	-	-	-	-	-	-
1 400	1 600	-	-	-	-	-	-	-	-	-	-	-	-	-	-	-	-	-	-

Diameter division mm		j5		js5		j6		js6		j7		k4		k5		k6		m5	
over	incl.	high	low	high	low	high	low	high	low	high	low	high	low	high	low	high	low	high	low
3	6	+3	-2	+2.5	-2.5	+6	-2	+4	-4	+8	-4	+5	+1	+6	+1	+9	+1	+9	+4
6	10	+4	-2	+3	-3	+7	-2	+4.5	-4.5	+10	-5	+5	+1	+7	+1	+10	+1	+12	+6
10	18	+5	-3	+4	-4	+8	-3	+5.5	-5.5	+12	-6	+6	+1	+9	+1	+12	+1	+15	+7
18	30	+5	-4	+4.5	-4.5	+9	-4	+6.5	-6.5	+13	-8	+8	+2	+11	+2	+15	+2	+17	+8
30	40	+6	-5	+5.5	-5.5	+11	-5	+8	-8	+15	-10	+9	+2	+13	+2	+18	+2	+20	+9
40	50	+6	-7	+6.5	-6.5	+12	-7	+9.5	-9.5	+18	-12	+10	+2	+15	+2	+21	+2	+24	+11
50	65	+6	-9	+7.5	-7.5	+13	-9	+11	-11	+20	-15	+13	+3	+18	+3	+25	+3	+28	+13
65	80	+7	-11	+9	-9	+14	-11	+12.5	-12.5	+22	-18	+15	+3	+21	+3	+28	+3	+33	+15
80	100	+7	-13	+10	-10	+16	-13	+14.5	-14.5	+25	-21	+18	+4	+24	+4	+33	+4	+37	+17
100	120	+7	-16	+11.5	-11.5	+16	-16	+16	-16	+26	-26	+20	+4	+27	+4	+36	+4	+43	+20
120	140	+7	-18	+12.5	-12.5	+18	-18	+18	-18	+29	-28	+22	+4	+29	+4	+40	+4	+46	+21
140	160	+7	-20	+13.5	-13.5	+20	-20	+20	-20	+31	-32	+25	+5	+32	+5	+45	+5	+50	+23
160	180	-	-	-	-	-	-	+22	-22	-	-	-	-	-	-	+44	0	-	-
180	200	-	-	-	-	-	-	+25	-25	-	-	-	-	-	-	+50	0	-	-
200	225	-	-	-	-	-	-	+28	-28	-	-	-	-	-	-	+56	0	-	-
225	250	-	-	-	-	-	-	+33	-33	-	-	-	-	-	-	+66	0	-	-
250	280	-	-	-	-	-	-	+39	-39	-	-	-	-	-	-	+78	0	-	-
280	315	-	-	-	-	-	-	-	-	-	-	-	-	-	-	-	-	-	-
315	355	-	-	-	-	-	-	-	-	-	-	-	-	-	-	-	-	-	-
355	400	-	-	-	-	-	-	-	-	-	-	-	-	-	-	-	-	-	-
400	450	-	-	-	-	-	-	-	-	-	-	-	-	-	-	-	-	-	-
450	500	-	-	-	-	-	-	-	-	-	-	-	-	-	-	-	-	-	-
500	560	-	-	-	-	-	-	-	-	-	-	-	-	-	-	-	-	-	-
560	630	-	-	-	-	-	-	-	-	-	-	-	-	-	-	-	-	-	-
630	710	-	-	-	-	-	-	-	-	-	-	-	-	-	-	-	-	-	-
710	800	-	-	-	-	-	-	-	-	-	-	-	-	-	-	-	-	-	-
800	900	-	-	-	-	-	-	-	-	-	-	-	-	-	-	-	-	-	-
900	1 000	-	-	-	-	-	-	-	-	-	-	-	-	-	-	-	-	-	-
1 000	1 120	-	-	-	-	-	-	-	-	-	-	-	-	-	-	-	-	-	-
1 120	1 250	-	-	-	-	-	-	-	-	-	-	-	-	-	-	-	-	-	-
1 250	1 400	-	-	-	-	-	-	-	-	-	-	-	-	-	-	-	-	-	-
1 400	1 600	-	-	-	-	-	-	-	-	-	-	-	-	-	-	-	-	-	-

Unit  $\mu\text{m}$

h4		h5		h6		h7		h8		h9		h10		h11		h13		js4		Diameter division mm	
high	low	high	low	high	low	high	low	high	low	high	low	high	low	high	low	high	low	high	low	over	incl.
0	-4	0	-5	0	-8	0	-12	0	-18	0	-30	0	-48	0	-75	0	-180	+2	-2	3	6
0	-4	0	-6	0	-9	0	-15	0	-22	0	-36	0	-58	0	-90	0	-220	+2	-2	6	10
0	-5	0	-8	0	-11	0	-18	0	-27	0	-43	0	-70	0	-110	0	-270	+2.5	-2.5	10	18
0	-6	0	-9	0	-13	0	-21	0	-33	0	-52	0	-84	0	-130	0	-330	+3	-3	18	30
0	-7	0	-11	0	-16	0	-25	0	-39	0	-62	0	-100	0	-160	0	-390	+3.5	-3.5	30	40
																				40	50
0	-8	0	-13	0	-19	0	-30	0	-46	0	-74	0	-120	0	-190	0	-460	+4	-4	50	65
																				65	80
0	-10	0	-15	0	-22	0	-35	0	-54	0	-87	0	-140	0	-220	0	-540	+5	-5	80	100
																				100	120
0	-12	0	-18	0	-25	0	-40	0	-63	0	-100	0	-160	0	-250	0	-630	+6	-6	120	140
																				140	160
																				160	180
0	-14	0	-20	0	-29	0	-46	0	-72	0	-115	0	-185	0	-290	0	-720	+7	-7	180	200
																				200	225
																				225	250
0	-16	0	-23	0	-32	0	-52	0	-81	0	-130	0	-210	0	-320	0	-810	+8	-8	250	280
																				280	315
0	-18	0	-25	0	-36	0	-57	0	-89	0	-140	0	-230	0	-360	0	-890	+9	-9	315	355
																				355	400
0	-20	0	-27	0	-40	0	-63	0	-97	0	-155	0	-250	0	-400	0	-970	+10	-10	400	450
																				450	500
-	-	-	-	0	-44	0	-70	0	-110	0	-175	0	-280	0	-440	0	-	-	-	500	560
																				560	630
-	-	-	-	0	-50	0	-80	0	-125	0	-200	0	-320	0	-500	0	-	-	-	630	710
																				710	800
-	-	-	-	0	-56	0	-90	0	-140	0	-230	0	-360	0	-560	0	-	-	-	800	900
																				900	1 000
-	-	-	-	0	-66	0	-105	0	-165	0	-260	0	-420	0	-660	0	-	-	-	1 000	1 120
																				1 120	1 250
-	-	-	-	0	-78	0	-125	0	-195	0	-310	0	-500	0	-780	0	-	-	-	1 250	1 400
																				1 400	1 600

Unit  $\mu\text{m}$

m6		n5		n6		p5		p6		r6		r7		Basic tolerance				Diameter division mm	
high	low	high	low	high	low	high	low	high	low	high	low	high	low	IT2	IT3	IT5	IT7	over	incl.
+12	+4	+13	+8	+16	+8	+17	+12	+20	+12	+23	+15	+27	+15	1.5	2.5	5	12	3	6
+15	+6	+16	+10	+19	+10	+21	+15	+24	+15	+28	+19	+34	+19	1.5	2.5	6	15	6	10
+18	+7	+20	+12	+23	+12	+26	+18	+29	+18	+34	+23	+41	+23	2	3	8	18	10	18
+21	+8	+24	+15	+28	+15	+31	+22	+35	+22	+41	+28	+49	+28	2.5	4	9	21	18	30
+25	+9	+28	+17	+33	+17	+37	+26	+42	+26	+50	+34	+59	+34	2.5	4	11	25	30	40
																		40	50
+30	+11	+33	+20	+39	+20	+45	+32	+51	+32	+60	+41	+71	+41	3	5	13	30	50	65
																		65	80
+35	+13	+38	+23	+45	+23	+52	+37	+59	+37	+73	+51	+86	+51	4	6	15	35	80	100
																		100	120
+40	+15	+45	+27	+52	+27	+61	+43	+68	+43	+88	+63	+103	+63	5	8	18	40	120	140
																		140	160
																		160	180
+46	+17	+51	+31	+60	+31	+70	+50	+79	+50	+106	+77	+123	+77	7	10	20	46	180	200
																		200	225
																		225	250
+52	+20	+57	+34	+66	+34	+79	+56	+88	+56	+126	+94	+146	+94	8	12	23	52	250	280
																		280	315
+57	+21	+62	+37	+73	+37	+87	+62	+98	+62	+144	+108	+165	+108	9	13	25	57	315	355
																		355	400
+63	+23	+67	+40	+80	+40	+95	+68	+108	+68	+166	+126	+189	+126	10	15	27	63	400	450
																		450	500
+70	+26	-	-	+88	+44	-	-	+122	+78	+194	+150	+220	+150	-	-	-	70	500	560
																		560	630
+80	+30	-	-	+100	+50	-	-	+138	+88	+225	+175	+255	+175	-	-	-	80	630	710
																		710	800
+90	+34	-	-	+112	+56	-	-	+156	+100	+266	+210	+300	+210	-	-	-	90	800	900
																		900	1 000
+106	+40	-	-	+132	+66	-	-	+186	+120	+316	+250	+355	+250	-	-	-	105	1 000	1 120
																		1 120	1 250
+126	+48	-	-	+156	+78	-	-	+218	+140	+378	+300	+425	+300	-	-	-	125	1 250	1 400
																		1 400	1 600

Table 6: Dimensional tolerance for housing bore

Diameter division mm	over	incl.	E7		E10		E11		E12		F6		F7		F8		G6		G7		H6	
			high	low	high	low	high	low	high	low	high	low	high	low	high	low	high	low	high	low		
3	6		+32	+20	+68	+20	+95	+20	+140	+20	+18	+10	+22	+10	+28	+10	+12	+4	+16	+4	+8	0
6	10		+40	+25	+83	+25	+115	+25	+175	+25	+22	+13	+28	+13	+35	+13	+14	+5	+20	+5	+9	0
10	18		+50	+32	+102	+32	+142	+32	+212	+32	+27	+16	+34	+16	+43	+16	+17	+6	+24	+6	+11	0
18	30		+61	+40	+124	+40	+170	+40	+250	+40	+33	+20	+41	+20	+53	+20	+20	+7	+28	+7	+13	0
30	40		+75	+50	+150	+50	+210	+50	+300	+50	+41	+25	+60	+25	+64	+25	+25	+9	+34	+9	+16	0
40	50				+180		+60		+360		+49	+30	+60	+30	+76	+30	+29	+10	+40	+10	+19	0
50	65		+90	+60		+60	+250	+60		+60	+58	+36	+71	+36	+90	+36	+34	+12	+47	+12	+22	0
65	80				+212		+72		+422		+58	+36	+71	+36	+90	+36	+34	+12	+47	+12	+22	0
80	100		+107	+72		+72	+292	+72		+422	+58	+36	+71	+36	+90	+36	+34	+12	+47	+12	+22	0
100	120																					0
120	140		+125	+85	+245	+85	+335	+85	+485	+85	+68	+43	+83	+43	+106	+43	+39	+14	+54	+14	+25	0
140	160																					0
160	180																					0
180	200																					0
200	225		+146	+100	+285	+100	+390	+100	+560	+100	+79	+50	+96	+50	+122	+50	+44	+15	+61	+15	+29	0
225	250																					0
250	280		+162	+110	+320	+110	+430	+110	+630	+110	+88	+56	+108	+56	+137	+56	+49	+17	+69	+17	+32	0
280	315																					0
315	355		+182	+125	+355	+125	+485	+125	+695	+125	+98	+62	+119	+62	+151	+62	+54	+18	+75	+18	+36	0
355	400																					0
400	450		+198	+135	+385	+135	+535	+135	+765	+135	+108	+68	+131	+68	+165	+68	+60	+20	+83	+20	+40	0
450	500																					0
500	560		+215	+145	-	-	-	-	-	-	+120	+76	+146	+76	+186	+76	+66	+22	+92	+22	+44	0
560	630																					0
630	710		+240	+160	-	-	-	-	-	-	+130	+80	+160	+80	+205	+80	+74	+24	+104	+24	+50	0
710	800																					0
800	900		+260	+170	-	-	-	-	-	-	+142	+86	+176	+86	+226	+86	+82	+26	+116	+26	+56	0
900	1000																					0
1 000	1 120		+300	+195	-	-	-	-	-	-	+164	+98	+203	+98	+263	+98	+94	+28	+133	+28	+66	0
1 120	1 250																					0
1 250	1 400		+345	+220	-	-	-	-	-	-	+188	+110	+235	+110	+305	+110	+108	+30	+155	+30	+78	0
1 400	1 600																					0
1 600	1 800		+390	+240	-	-	-	-	-	-	+212	+120	+270	+120	+350	+120	+124	+32	+182	+32	+92	0
1 800	2 000																					0

Unit  $\mu\text{m}$

Diameter division mm	over	incl.	K6		K7		M6		M7		N6		N7		P6		P7		R6		R7	
			high	low	high	low	high	low	high	low	high	low	high	low	high	low	high	low	high	low	high	low
3	6		+2	-6	+3	-9	-1	-9	0	-12	-5	-13	-4	-16	-9	-17	-8	-20	-12	-20	-11	-23
6	10		+2	-7	+5	-10	-3	-12	0	-15	-7	-16	-4	-19	-12	-21	-9	-24	-16	-25	-13	-28
10	18		+2	-9	+6	-12	-4	-15	0	-18	-9	-20	-5	-23	-15	-26	-11	-29	-20	-31	-16	-34
18	30		+2	-11	+6	-15	-4	-17	0	-21	-11	-24	-7	-28	-18	-31	-14	-35	-24	-37	-20	-41
30	40		+3	-13	+7	-18	-4	-20	0	-25	-12	-28	-8	-33	-21	-37	-17	-45	-29	-42	-25	-50
40	50																					
50	65		+4	-15	+9	-21	-5	-24	0	-30	-14	-33	-9	-39	-26	-45	-21	-51	-35	-54	-30	-60
65	80																		-37	-56	-32	-62
80	100		+4	-18	+10	-25	-6	-28	0	-35	-16	-38	-10	-45	-30	-52	-24	-59	-44	-66	-38	-73
100	120																		-47	-69	-41	-76
120	140																		-56	-81	-48	-88
140	160		+4	-21	+12	-28	-8	-33	0	-40	-20	-45	-12	-52	-36	-61	-28	-68	-58	-83	-50	-90
160	180																		-61	-86	-53	-93
180	200																		-68	-97	-60	-106
200	225		+5	-24	+13	-33	-8	-37	0	-46	-22	-51	-14	-60	-41	-70	-33	-79	-71	-100	-63	-109
225	250																		-75	-104	-67	-113
250	280		+5	-27	+16	-36	-9	-41	0	-52	-25	-57	-14	-66	-47	-79	-36	-88	-85	-117	-74	-126
280	315																		-89	-121	-78	-130
315	355		+7	-29	+17	-40	-10	-46	0	-57	-26	-62	-16	-73	-51	-87	-41	-98	-97	-133	-87	-144
355	400																		-103	-139	-93	-150
400	450		+8	-32	+18	-45	-10	-50	0	-63	-27	-67	-17	-80	-55	-95	-45	-108	-113	-153	-103	-166
450	500																		-119	-159	-109	-172
500	560		0	-44	0	-70	-26	-70	-26	-96	-44	-88	-44	-114	-78	-122	-78	-148	-150	-194	-150	-220
560	630																		-155	-199	-155	-225
630	710		0	-50	0	-80	-30	-80	-30	-100	-50	-100	-50	-130	-88	-138	-88	-168	-175	-225	-175	-225
710	800																		-185	-235	-185	-265
800	900		0	-56	0	-90	-34	-90	-34	-124	-56	-112	-56	-146	-100	-156	-100	-190	-210	-266	-210	-300
900	1000																		-220	-276	-220	-310
1 000	1 120		0	-66	0	-105	-40	-106	-40	-145	-66	-132	-66	-171	-120	-186	-120	-225	-250	-316	-250	-355
1 120	1 250																		-260	-326	-260	-365
1 250	1 400		0	-78	0	-125	-48	-126	-48	-173	-78	-156	-78	-203	-140	-218	-140	-265	-300	-378	-300	-425
1 400	1 600																		-330	-408	-330	-455
1 600	1 800		0	-92	0	-150	-58	-150	-58	-208	-92	-184	-92	-242	-170	-262	-170	-320	-370	-462	-370	-520
1 800	2 000																		-400	-492	-400	-550



Unit  $\mu\text{m}$

H7		H8		H9		H10		H11		H13		J6		Js6		J7		Js7		K5		Diameter division mm over incl.	
high	low	high	low	high	low	high	low	high	low	high	low	high	low	high	low	high	low	high	low	high	low		
+12	0	+18	0	+30	0	+48	0	+75	0	+180	0	+5	-3	+4	-4	+6	-6	+6	-6	0	-5	3	6
+15	0	+22	0	+36	0	+58	0	+90	0	+220	0	+5	-4	+4.5	-4.5	+8	-7	+7.5	-7.5	+1	-5	6	10
+18	0	+27	0	+43	0	+70	0	+110	0	+270	0	+6	-5	+5.5	-5.5	+10	-8	+9	-9	+2	-6	10	18
+21	0	+33	0	+52	0	+84	0	+130	0	+330	0	+8	-5	+6.5	-6.5	+12	-9	+10.5	-10.5	+1	-8	18	30
+25	0	+39	0	+62	0	+100	0	+160	0	+390	0	+10	-6	+8	-8	+14	-11	+12.5	-12.5	+2	-9	30	40
																						40	50
+30	0	+46	0	+74	0	+120	0	+190	0	+460	0	+13	-6	+9.5	-9.5	+18	-12	+15	-15	+3	-10	50	65
																						65	80
+35	0	+54	0	+87	0	+140	0	+220	0	+540	0	+16	-6	+11	-11	+22	-13	+17.5	-17.5	+2	-13	80	100
																						100	120
+40	0	+63	0	+100	0	+160	0	+250	0	+630	0	+18	-7	+12.5	-12.5	+26	-14	+20	-20	+3	-15	120	140
																						140	160
																						160	180
+46	0	+72	0	+115	0	+185	0	+290	0	+720	0	+22	-7	+14.5	-14.5	+30	-16	+23	-23	+2	-18	180	200
																						200	225
																						225	250
+52	0	+81	0	+130	0	+210	0	+320	0	+810	0	+25	-7	+16	-16	+36	-16	+26	-26	+3	-20	250	280
																						280	315
+57	0	+89	0	+140	0	+230	0	+360	0	+890	0	+29	-7	+18	-18	+39	-18	+28.5	-28.5	+3	-22	315	355
																						355	400
+63	0	+97	0	+155	0	+250	0	+400	0	+970	0	+33	-7	+20	-20	+43	-20	+31.5	-31.5	+2	-25	400	450
																						450	500
+70	0	+110	0	+175	0	+280	0	+440	0	-	0	-	-	+22	-22	-	-	+35	-35	-	-	500	560
																						560	630
+80	0	+125	0	+200	0	+320	0	+500	0	-	0	-	-	+25	-25	-	-	+40	-40	-	-	630	710
																						710	800
+90	0	+140	0	+230	0	+360	0	+560	0	-	0	-	-	+28	-28	-	-	+45	-45	-	-	800	900
																						900	1000
+105	0	+165	0	+260	0	+420	0	+660	0	-	0	-	-	+33	-33	-	-	+52.5	-52.5	-	-	1000	1120
																						1120	1250
+125	0	+195	0	+310	0	+500	0	+780	0	-	0	-	-	+39	-39	-	-	+62.5	-62.5	-	-	1250	1400
																						1400	1600
+150	0	+230	0	+370	0	+600	0	+920	0	-	0	-	-	+46	-46	-	-	+75	-75	-	-	1600	1800
																						1800	2000

Table 7: Basic tolerance

Unit  $\mu\text{m}$

Diameter division mm		IT basic tolerance class									
over	incl.	IT1	IT2	IT3	IT4	IT5	IT6	IT7	IT8	IT9	IT10
—	3	0.8	1.2	2	3	4	6	10	14	25	40
3	6	1	1.5	2.5	4	5	8	12	18	30	48
6	10	1	1.5	2.5	4	6	9	15	22	36	58
10	18	1.2	2	3	5	8	11	18	27	43	70
18	30	1.5	2.5	4	6	9	13	21	33	52	84
30	50	1.5	2.5	4	7	11	16	25	39	62	100
50	80	2	3	5	8	13	19	30	46	74	120
80	120	2.5	4	6	10	15	22	35	54	87	140
120	180	3.5	5	8	12	18	25	40	63	100	160
180	250	4.5	7	10	14	20	29	46	72	115	185
250	315	6	8	12	16	23	32	52	81	130	210
315	400	7	9	13	18	25	36	57	89	140	230
400	500	8	10	15	20	27	40	63	97	155	250
500	630	9	11	16	22	30	44	70	110	175	280
630	800	10	13	18	25	35	50	80	125	200	320
800	1 000	11	15	21	29	40	56	90	140	230	360
1 000	1 250	13	18	24	34	46	66	105	165	260	420
1 250	1 600	15	21	29	40	54	78	125	195	310	500
1 600	2 000	18	25	35	48	65	92	150	230	370	600
2 000	2 500	22	30	41	57	77	110	175	280	440	700
2 500	3 150	26	36	50	69	93	135	210	330	540	860

Table 8: Viscosity conversion table

Kinematic viscosity mm <sup>2</sup> /s	Saybolt SUS (second)	Redwood R*(second)	Engler E (degree)
2.7	35	32.2	1.18
4.3	40	36.2	1.32
5.9	45	40.6	1.46
7.4	50	44.9	1.60
8.9	55	49.1	1.75
10.4	60	53.5	1.88
11.8	65	57.9	2.02
13.1	70	62.3	2.15
14.5	75	67.6	2.31
15.8	80	71.0	2.42
17.0	85	75.1	2.55
18.2	90	79.6	2.68
19.4	95	84.2	2.81
20.6	100	88.4	2.95
23.0	110	97.1	3.21
25.0	120	105.9	3.49
27.5	130	114.8	3.77
29.8	140	123.6	4.04
32.1	150	132.4	4.32
34.3	160	141.1	4.59
36.5	170	150.0	4.88
38.8	180	158.8	5.15
41.0	190	167.5	5.44
43.2	200	176.4	5.72
47.5	220	194.0	6.28
51.9	240	212	6.85
56.5	260	229	7.38
60.5	280	247	7.95
64.9	300	265	8.51
70.3	325	287	9.24
75.8	350	309	9.95
81.2	375	331	10.7
86.8	400	353	11.4
92.0	425	375	12.1
97.4	450	397	12.8

Kinematic viscosity mm <sup>2</sup> /s	Saybolt SUS (second)	Redwood R*(second)	Engler E (degree)
103	475	419	13.5
108	500	441	14.2
119	550	485	15.6
130	600	529	17.0
141	650	573	18.5
152	700	617	19.9
163	750	661	21.3
173	800	705	22.7
184	850	749	24.2
195	900	793	25.6
206	950	837	27.0
217	1 000	882	28.4
260	1 200	1 058	34.1
302	1 400	1 234	39.8
347	1 600	1 411	45.5
390	1 800	1 587	51
433	2 000	1 763	57
542	2 500	2 204	71
650	3 000	2 646	85
758	3 500	3 087	99
867	4 000	3 526	114
974	4 500	3 967	128
1 082	5 000	4 408	142
1 150	5 500	4 849	156
1 300	6 000	5 290	170
1 400	6 500	5 730	185
1 510	7 000	6 171	199
1 630	7 500	6 612	213
1 740	8 000	7 053	227
1 850	8 500	7 494	242
1 960	9 000	7 934	256
2 070	9 500	8 375	270
2 200	10 000	8 816	284

**Table 9: Kgf to N conversion table**

kgf		N
0.1020	<b>1</b>	9.8066
0.2039	<b>2</b>	19.613
0.3059	<b>3</b>	29.420
0.4079	<b>4</b>	39.227
0.5099	<b>5</b>	49.033
0.6118	<b>6</b>	58.840
0.7138	<b>7</b>	68.646
0.8158	<b>8</b>	78.453
0.9177	<b>9</b>	88.260
1.0197	<b>10</b>	98.066
1.1217	<b>11</b>	107.87
1.2237	<b>12</b>	117.68
1.3256	<b>13</b>	127.49
1.4276	<b>14</b>	137.29
1.5296	<b>15</b>	147.10
1.6316	<b>16</b>	156.91
1.7335	<b>17</b>	166.71
1.8355	<b>18</b>	176.52
1.9375	<b>19</b>	186.33
2.0394	<b>20</b>	196.13
2.1414	<b>21</b>	205.94
2.2434	<b>22</b>	215.75
2.3454	<b>23</b>	225.55
2.4473	<b>24</b>	235.36
2.5493	<b>25</b>	245.17
2.6513	<b>26</b>	254.97
2.7532	<b>27</b>	264.78
2.8552	<b>28</b>	274.59
2.9572	<b>29</b>	284.39
3.0592	<b>30</b>	294.20
3.1611	<b>31</b>	304.01
3.2631	<b>32</b>	313.81
3.3651	<b>33</b>	323.62

kgf		N
3.4670	<b>34</b>	333.43
3.5690	<b>35</b>	343.23
3.6710	<b>36</b>	353.04
3.7730	<b>37</b>	362.85
3.8749	<b>38</b>	372.65
3.9769	<b>39</b>	382.46
4.0789	<b>40</b>	392.27
4.1808	<b>41</b>	402.07
4.2828	<b>42</b>	411.88
4.3848	<b>43</b>	421.68
4.4868	<b>44</b>	431.49
4.5887	<b>45</b>	441.30
4.6907	<b>46</b>	451.10
4.7927	<b>47</b>	460.91
4.8946	<b>48</b>	470.72
4.9966	<b>49</b>	480.52
5.0986	<b>50</b>	490.33
5.2006	<b>51</b>	500.14
5.3025	<b>52</b>	509.94
5.4045	<b>53</b>	519.75
5.5065	<b>54</b>	529.56
5.6085	<b>55</b>	539.36
5.7104	<b>56</b>	549.17
5.8124	<b>57</b>	558.98
5.9144	<b>58</b>	568.78
6.0163	<b>59</b>	578.59
6.1183	<b>60</b>	588.40
6.2203	<b>61</b>	598.20
6.3223	<b>62</b>	608.01
6.4242	<b>63</b>	617.82
6.5262	<b>64</b>	627.62
6.6282	<b>65</b>	637.43
6.7302	<b>66</b>	647.24

kgf		N
6.8321	<b>67</b>	657.04
6.9341	<b>68</b>	666.85
7.0361	<b>69</b>	676.66
7.1380	<b>70</b>	686.46
7.2400	<b>71</b>	696.27
7.3420	<b>72</b>	706.08
7.4440	<b>73</b>	715.88
7.5459	<b>74</b>	725.69
7.6479	<b>75</b>	735.50
7.7499	<b>76</b>	745.30
7.8518	<b>77</b>	755.11
7.9538	<b>78</b>	764.92
8.0558	<b>79</b>	774.72
8.1578	<b>80</b>	784.53
8.2597	<b>81</b>	794.34
8.3617	<b>82</b>	804.14
8.4637	<b>83</b>	813.95
8.5656	<b>84</b>	823.76
8.6676	<b>85</b>	833.56
8.7696	<b>86</b>	843.37
8.8716	<b>87</b>	853.18
8.9735	<b>88</b>	862.98
9.0755	<b>89</b>	872.79
9.1775	<b>90</b>	882.60
9.2794	<b>91</b>	892.40
9.3814	<b>92</b>	902.21
9.4834	<b>93</b>	912.02
9.5854	<b>94</b>	921.82
9.6873	<b>95</b>	931.63
9.7893	<b>96</b>	941.44
9.8913	<b>97</b>	951.24
9.9932	<b>98</b>	961.05
10.0952	<b>99</b>	970.86

(How to read the table) If for example you want to convert 10 kgf to N, find "10" in the middle column of the first set of columns on the right. Look in the N column directly to the right of "10," and you will see that 10 kgf equals 98.066 N. Oppositely, to convert 10 N to kgf, look in the kgf column to the right of "10" and you will see that 10 N equals 1.0197 kgf.

1kgf=9.80665N  
1N=0.101972kgf

Table 10: Inch-millimetre conversion table

inch		0"	1"	2"	3"	4"	5"	6"	7"	8"	9"
fraction	decimal										
1/64	0.015625	0.397	25.400	50.800	76.200	101.600	127.000	152.400	177.800	203.200	228.600
1/32	0.031250	0.794	25.797	51.197	76.597	101.997	127.397	152.797	178.197	203.597	228.997
3/64	0.046875	1.191	26.591	51.594	76.994	102.394	127.794	153.194	178.594	203.994	229.394
1/16	0.062500	1.588	26.988	52.388	77.788	103.188	128.588	153.988	179.388	204.788	230.188
5/64	0.078125	1.984	27.384	52.784	78.184	103.584	128.984	154.384	179.784	205.184	230.584
3/32	0.093750	2.381	27.781	53.181	78.581	103.981	129.381	154.781	180.181	205.581	230.981
7/64	0.109375	2.778	28.178	53.578	78.978	104.378	129.778	155.178	180.578	205.978	231.378
1/8	0.125000	3.175	28.575	53.975	79.375	104.775	130.175	155.575	180.975	206.375	231.775
9/64	0.140625	3.572	28.972	54.372	79.772	105.172	130.572	155.972	181.372	206.772	232.172
5/32	0.156250	3.969	29.369	54.769	80.169	105.569	130.969	156.369	181.769	207.169	232.569
11/64	0.171875	4.366	29.766	55.166	80.566	105.966	131.366	156.766	182.166	207.566	232.966
3/16	0.187500	4.762	30.162	55.562	80.962	106.362	131.762	157.162	182.562	207.962	233.362
13/64	0.203125	5.159	30.559	55.959	81.359	106.759	132.159	157.559	182.959	208.359	233.759
7/32	0.218750	5.556	30.956	56.356	81.756	107.156	132.556	157.956	183.356	208.756	234.156
15/64	0.234375	5.953	31.353	56.753	82.153	107.553	132.953	158.353	183.753	209.153	234.553
1/4	0.250000	6.350	31.750	57.150	82.550	107.950	133.350	158.750	184.150	209.550	234.950
17/64	0.265625	6.747	32.147	57.547	82.947	108.347	133.747	159.147	184.547	209.947	235.347
9/32	0.281250	7.144	32.544	57.944	83.344	108.744	134.144	159.544	184.944	210.344	235.744
19/64	0.296875	7.541	32.941	58.341	83.741	109.141	134.541	159.941	185.341	210.741	236.141
5/16	0.312500	7.938	33.338	58.738	84.138	109.538	134.938	160.338	185.738	211.138	236.538
21/64	0.328125	8.334	33.734	59.134	84.534	109.934	135.334	160.734	186.134	211.534	236.934
11/32	0.343750	8.731	34.131	59.531	84.931	110.331	135.731	161.131	186.531	211.931	237.331
23/64	0.359375	9.128	34.528	59.928	85.328	110.728	136.128	161.528	186.928	212.328	237.728
3/8	0.375000	9.525	34.925	60.325	85.725	111.125	136.525	161.925	187.325	212.725	238.125
25/64	0.390625	9.922	35.322	60.722	86.122	111.522	136.922	162.322	187.722	213.122	238.522
13/32	0.406250	10.319	35.719	61.119	86.519	111.919	137.319	162.719	188.119	213.519	238.919
27/64	0.421875	10.716	36.116	61.516	86.916	112.316	137.716	163.116	188.516	213.916	239.316
7/16	0.437500	11.112	36.512	61.912	87.312	112.712	138.112	163.512	188.912	214.312	239.712
29/64	0.453125	11.509	36.909	62.309	87.709	113.109	138.509	163.909	189.309	214.709	240.109
15/32	0.468750	11.906	37.306	62.706	88.106	113.506	138.906	164.306	189.706	215.106	240.506
31/64	0.484375	12.303	37.703	63.103	88.503	113.903	139.303	164.703	190.103	215.503	240.903
1/2	0.500000	12.700	38.100	63.500	88.900	114.300	139.700	165.100	190.500	215.900	241.300
33/64	0.515625	13.097	38.497	63.897	89.297	114.697	140.097	165.497	190.897	216.297	241.697
17/32	0.531250	13.494	38.894	64.294	89.694	115.094	140.494	165.894	191.294	216.694	242.094
35/64	0.546875	13.891	39.291	64.691	90.091	115.491	140.891	166.291	191.691	217.091	242.491
9/16	0.562500	14.288	39.688	65.088	90.488	115.888	141.288	166.688	192.088	217.488	242.888
37/64	0.578125	14.684	40.084	65.484	90.884	116.284	141.684	167.084	192.484	217.884	243.284
19/32	0.593750	15.081	40.481	65.881	91.281	116.681	142.081	167.481	192.881	218.281	243.681
39/64	0.609375	15.478	40.878	66.278	91.678	117.078	142.478	167.878	193.278	218.678	244.078
5/8	0.625000	15.875	41.275	66.675	92.075	117.475	142.875	168.275	193.675	219.075	244.475
41/64	0.640625	16.272	41.672	67.072	92.472	117.872	143.272	168.672	194.072	219.472	244.872
21/32	0.656250	16.669	42.069	67.469	92.869	118.269	143.669	169.069	194.469	219.869	245.269
43/64	0.671875	17.066	42.466	67.866	93.266	118.666	144.066	169.466	194.866	220.266	245.666
11/16	0.687500	17.462	42.862	68.262	93.662	119.062	144.462	169.862	195.262	220.662	246.062
45/64	0.703125	17.859	43.259	68.659	94.059	119.459	144.859	170.259	195.659	221.059	246.459
23/32	0.718750	18.256	43.656	69.056	94.456	119.856	145.256	170.656	196.056	221.456	246.856
47/64	0.734375	18.653	44.053	69.453	94.853	120.253	145.653	171.053	196.453	221.853	247.253
3/4	0.750000	19.050	44.450	69.850	95.250	120.650	146.050	171.450	196.850	222.250	247.650
49/64	0.765625	19.447	44.847	70.247	95.647	121.047	146.447	171.847	197.247	222.647	248.047
25/32	0.781250	19.844	45.244	70.644	96.044	121.444	146.844	172.244	197.644	223.044	248.444
51/64	0.796875	20.241	45.641	71.041	96.441	121.841	147.241	172.641	198.041	223.441	248.841
13/16	0.812500	20.638	46.038	71.438	96.838	122.238	147.638	173.038	198.438	223.838	249.238
53/64	0.828125	21.034	46.434	71.834	97.234	122.634	148.034	173.434	198.834	224.234	249.634
27/32	0.843750	21.431	46.831	72.231	97.631	123.031	148.431	173.831	199.231	224.631	250.031
55/64	0.859375	21.828	47.228	72.628	98.028	123.428	148.828	174.228	199.628	225.028	250.428
7/8	0.875000	22.225	47.625	73.025	98.425	123.825	149.225	174.625	200.025	225.425	250.825
57/64	0.890625	22.622	48.022	73.422	98.822	124.222	149.622	175.022	200.422	225.822	251.222
39/32	0.906250	23.019	48.419	73.819	99.219	124.619	150.019	175.419	200.819	226.219	251.619
59/64	0.921875	23.416	48.816	74.216	99.616	125.016	150.416	175.816	201.216	226.616	252.016
15/16	0.937500	23.812	49.212	74.612	100.012	125.412	150.812	176.212	201.612	227.012	252.412
61/64	0.953125	24.209	49.609	75.009	100.409	125.809	151.209	176.609	202.009	227.409	252.809
31/32	0.968750	24.606	50.006	75.406	100.806	126.206	151.606	177.006	202.406	227.806	253.206
63/64	0.984375	25.003	50.403	75.803	101.203	126.603	152.003	177.403	202.803	228.203	253.603

Table 11: Hardness conversion table (reference)

Rockwell hardness C scale 1471.0N {150kgf}	Vicker's hardness	Brinell hardness		Rockwell hardness		Shore hardness
		Standard steel balls	Tungsten carbide steel balls	A scale 588.4N {60kgf}	B scale 980.7N {100kgf}	
68	940			85.6		97
67	900			85.0		95
66	865			84.5		92
65	832		739	83.9		91
64	800		722	83.4		88
63	772		705	82.8		87
62	746		688	82.3		85
61	720		670	81.8		83
60	697		654	81.2		81
59	674		634	80.7		80
58	653		615	80.1		78
57	633		595	79.6		76
56	613		577	79.0		75
55	595	—	560	78.5		74
54	577	—	543	78.0		72
53	560	—	525	77.4		71
52	544	500	512	76.8		69
51	528	487	496	76.3		68
50	513	475	481	75.9		67
49	498	464	469	75.2		66
48	484	451	455	74.7		64
47	471	442	443	74.1		63
46	458	432	432	73.6		62
45	446	421	421	73.1		60
44	434	409	409	72.5		58
43	423	400	400	72.0		57
42	412	390	390	71.5		56
41	402	381	381	70.9		55
40	392	371	371	70.4	—	54
39	382	362	362	69.9	—	52
38	372	353	353	69.4	—	51
37	363	344	344	68.9	—	50
36	354	336	336	68.4	(109.0)	49
35	345	327	327	67.9	(108.5)	48
34	336	319	319	67.4	(108.0)	47
33	327	311	311	66.8	(107.5)	46
32	318	301	301	66.3	(107.0)	44
31	310	294	294	65.8	(106.0)	43
30	302	286	286	65.3	(105.5)	42
29	294	279	279	64.7	(104.5)	41
28	286	271	271	64.3	(104.0)	41
27	279	264	264	63.8	(103.0)	40
26	272	258	258	63.3	(102.5)	38
25	266	253	253	62.8	(101.5)	38
24	260	247	247	62.4	(101.0)	37
23	254	243	243	62.0	100.0	36
22	248	237	237	61.5	99.0	35
21	243	231	231	61.0	98.5	35
20	238	226	226	60.5	97.8	34
(18)	230	219	219	—	96.7	33
(16)	222	212	212	—	95.5	32
(14)	213	203	203	—	93.9	31
(12)	204	194	194	—	92.3	29
(10)	196	187	187	—	90.7	28
( 8)	188	179	179	—	89.5	27
( 6)	180	171	171	—	87.1	26
( 4)	173	165	165	—	85.5	25
( 2)	166	158	158	—	83.5	24
( 0)	160	152	152	—	81.7	24

Note 1: From hardness conversion table (SAE J417)

Table 12: Greek alphabet list

Upright	Italic		Reading
Upper case	Upper case	Lower case	
A	<i>A</i>	<i>α</i>	Alpha
B	<i>B</i>	<i>β</i>	Beta
Γ	<i>Γ</i>	<i>γ</i>	Gamma
Δ	<i>Δ</i>	<i>δ</i>	Delta
E	<i>E</i>	<i>ε</i>	Epsilon
Z	<i>Z</i>	<i>ζ</i>	Zeta
H	<i>H</i>	<i>η</i>	Eta
Θ	<i>Θ</i>	<i>θ</i>	Theta
I	<i>I</i>	<i>ι</i>	Iota
K	<i>K</i>	<i>κ</i>	Kappa
Λ	<i>Λ</i>	<i>λ</i>	Lambda
M	<i>M</i>	<i>μ</i>	Mu
N	<i>N</i>	<i>ν</i>	Nu
Ξ	<i>Ξ</i>	<i>ξ</i>	Xi
O	<i>O</i>	<i>ο</i>	Omicron
Π	<i>Π</i>	<i>π</i>	Pi
P	<i>P</i>	<i>ρ</i>	Rho
Σ	<i>Σ</i>	<i>σ</i>	Sigma
T	<i>T</i>	<i>τ</i>	Tau
Υ	<i>Υ</i>	<i>υ</i>	Upsilon
Φ	<i>Φ</i>	<i>φ</i>	Phi
X	<i>X</i>	<i>χ</i>	Chi
Ψ	<i>Ψ</i>	<i>ψ</i>	Psi
Ω	<i>Ω</i>	<i>ω</i>	Omega